



2019

Puig
Hi-Tech Parts

The logo features the word "Puig" in a bold, black, italicized sans-serif font. Below it, the words "Hi-Tech Parts" are written in a smaller, black, italicized sans-serif font. A red, curved swoosh element starts behind the "g" in "Puig" and extends to the right, partially overlapping the "Hi-Tech" text.

A	ACCESSORIES	448	G	GRIPS	277		SHEETS	408
	ADHESIVE NAKED YOKE & TANK PADS	371	H	HANDGUARDS	109		SIDE PANELS	139
	ADHESIVE RADIKAL YOKE & TANK PADS	379		HANDLEBARS	261		SPARES	441
	ADHESIVE STRIPS	355		HEADLIGHT PROTECTOR	191		SPECIAL RIM STRIPS	359
	ADHESIVE STRIPS PREMIUM	357	I	INTEGRATED TURN SIGNALS	408		SPIRIT TANK PADS	400
	ADHESIVE TANK PADS	367	L	LEVERS 2.0	215		SPOOLS	263
	ADHESIVE X-TREME YOKE & TANK PADS	387		LEVERS ADAPTERS	218		STAND SUPPORTS	436
	AUXILIARY LIGHTS	187		LEVERS HERITAGE	229		SUPPORT FOR ORIGINAL TURN SIGNAL	203
	AXLE SLIDERS	169		LICENSE SUPPORTS	193		SUPPORTS AUXILIARY LIGHTS	189
B	BAR ENDS	255		LIGHTING LICENSE SUPPORT	200	T	SWIN ARM PROTECTOR GS	363
	BOX COVERS	440	M	MAINTENANCE	444		TANK PADS	394
	BRAKE-CLUTCH LIQUID TANK COVER	207		MERCHANDISING	454		TANK PADS WINGS	398
C	CHASSIS CAP COVERS	149		MULTIADJUSTABLE VISORS CLIP-ON	51		TANK SIDE PROTECTORS ANTI-SLIP	369
	COVER - DEFLECTORS	143		MULTIADJUSTABLE VISORS FIXED BY SCREWS	49		TOP BOXES	438
D	DEFLECTORS FOR WINDSHIELDS	53	O	OFF-ROAD LEVERS	231		TURN SIGNAL COVERS	411
	DOWNFORCE SPOILERS	137	P	PASSENGER HANGERS	273		TURN SIGNALS	416
E	E.R.S.	47		PERFORMANCE TANK PADS	396	V	VALVES	265
	ENGINE CASE COVER	183		PLUG-OIL CAPS	267	W	WINDSCREENS FOR FAIRING BIKES	24
	ENGINE GUARDS	185		PROTECTOR SCRATCH SAVER	365		WINDSHIELDS FOR CUSTOM MOTORCYCLES	344
	ENGINE SPOILERS	133	R	RACE FUEL CAPS	269		WINDSHIELDS FOR MAXISCOOTERS	103
	EQUIPPED MOTORCYCLES	12		RADIATOR SIDE PANELS	141		WINDSHIELDS FOR MAXISCOOTERS	322
F	FENDER EXTENSIONS	131		REAR FENDER EXTENSION	123		WINDSHIELDS HIGH FOR ROUND HEADLIGHTS	339
	FILTER COVER	213		REAR FENDERS	115		WINDSHIELDS LOW FOR ROUND HEADLIGHTS	329
	FOOTPEGS	239		REAR LIGHTS	434		WINDSHIELDS SPECIFIC FOR NON-ROUND HEADLIGHTS	55
	FOOTPEGS ADAPTERS	246		REAR MIRRORS	287		WINDSHIELDS UNIVERSAL FOR NON-ROUND HEADLIGHTS	62
	FRAMES SLIDERS	151		RETROVISIONS	93		WINTER	446
	FRONT FENDER	125	S	RIM STRIPS GS	363	Y	YAMAHA T-MAX 530 / KYMCO AK550	317
	FRONT FENDER EXTENSION	127		SCREWS	442		APPENDIX TABLES	459
	FRONTAL PLATE (IN ABS)	97		SEMI-FAIRINGS	91			
	FRONTAL PLATE (IN ALUMINIUM)	95		SEQUENTIALS TURN SIGNALS	415			

OUR PASSION FROM WITHIN.

For the second consecutive year, 2018 has been a year to include in our history books for the achievements reached by our brand. PUIG has accomplished double **WORLD CHAMPIONSHIP** on the most prestigious competitions on two wheels:

MOTOGP 2018: WORLD CHAMPIONS with HRC Team and rider **MARC MÁRQUEZ**.

SUPERBIKES 2018: WORLD CHAMPIONS with KRT Team and rider **JONATHAN REA**.

The technical collaboration with both teams throughout the year has allowed us to test/improve on product materials, shapes, and designs which have been already applied on products showing on this 2019 catalog.

Also, it has been a productive year for the addition of new products where we feature:

- **Aerodynamic line:** the Electronic Regulation System (ERS), aluminium frontal plate, and spoilers Downforce.
- **Protection line:** R19 Sliders and PHB19 front and rear axle sliders, which are evolutions of current products. Moreover, the nylon engine protectors will be introduced within the first quarter of 2019.
- **Illumination line:** High range antifog lights to mount on the engine guards or through supports specifically designed to fit each motorcycle. Also featuring a new set of turn signals sequential homologated at a very competitive price.
- **CNC aluminium line:** Levers and footpegs Heritage for retro-custom bikes.
- **CNC aluminium rear mirrors:** introducing three new models - Grand Tracker, Retro, and GTI. This last model with turn signal incorporated.

Once again, we appreciate the trust on our brand, which help us maintain our commitment to keep this catalog up to date, year by year.



HISTORIC AND UNFORGETTABLE YEAR FOR PUIG AS A
TECHNICAL PARTNER WITH 4 CHAMPIONSHIPS CROWNS
ON **MOTOGP**, **WORLD SBK**, **WORLD SSP**, AND **BSB**.

Puig
Hi-Tech Parts

MARC MÁRQUEZ
HRC. 2018 MOTOGP WORLD CHAMPION

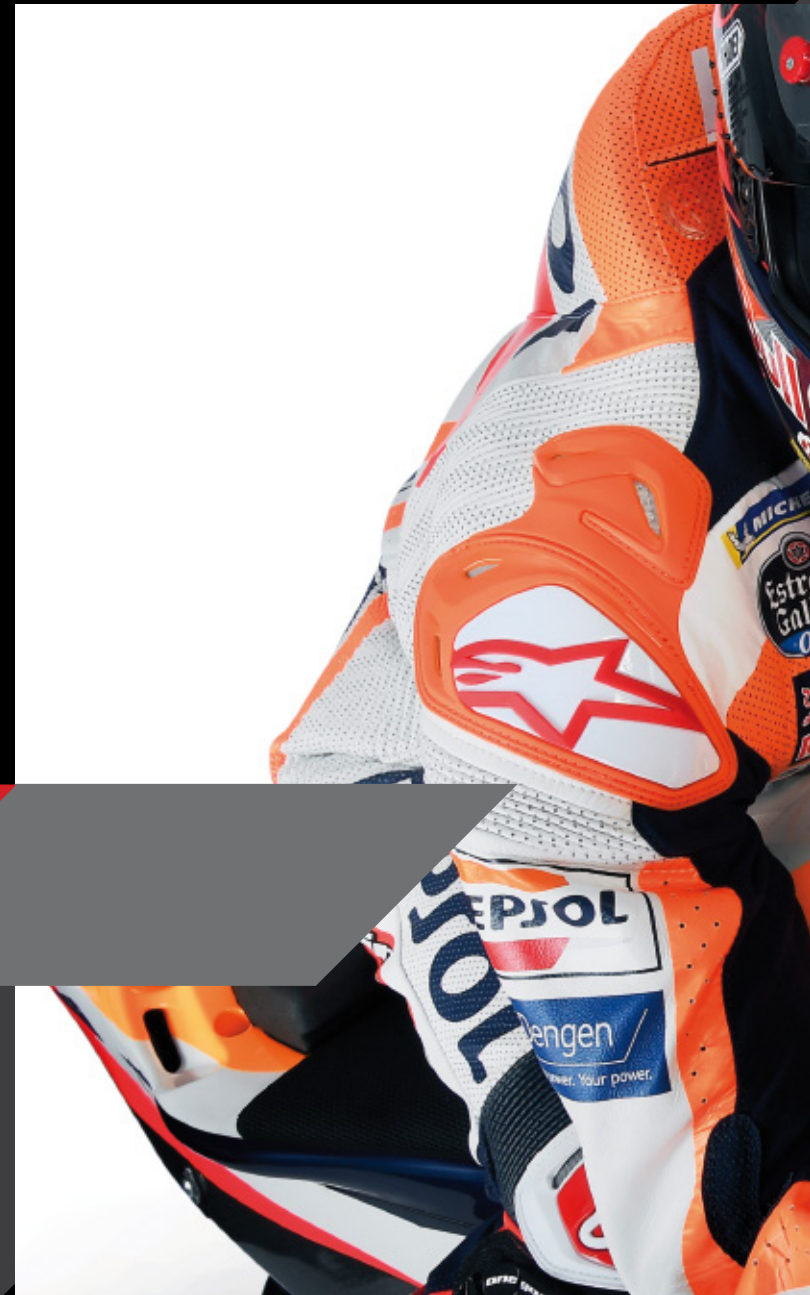



PULL & BEAR

93

Puig
Hi-Tech Parts

Red Bull

REP

HONDA

HRC

Puig
Hi-Tech Parts

JONATHAN REA
KRT. 2018 WORLD SBK CHAMPION









P. 115



P. 137



P. 157



P. 169



P. 193



P. 215



P. 263



P. 267



P. 303





P. 55



P. 133



P. 153



P. 171



P. 193



P. 239



P. 263



P. 267



P. 287





P. 103



P. 193



P. 215



P. 241



P. 317



P. 317



P. 318



P. 319



P. 365





P. 95



P. 133



P. 153



P. 169



P. 169



P. 187



P. 193



P. 243



P. 295





P. 95



P. 125



P. 193



P. 213



P. 229



P. 243





P. 109



P. 123



P. 139



P. 146



P. 146



P. 185



P. 187



P. 191



P. 363





// SCREEN TESTED IN THE VIRTUAL WIND TUNNEL

Improved aerodynamics and wind protection on average 12,7% compared with OEM screen.

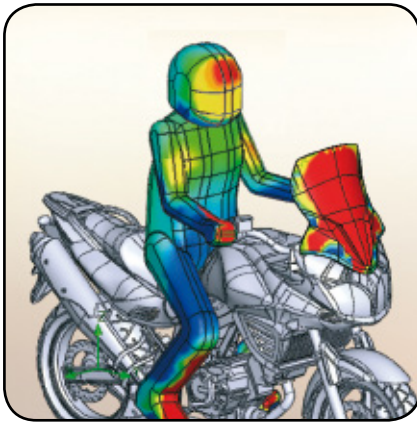

● Lower pressure
● Max. pressure
Wind pressure with a PUIG screen.

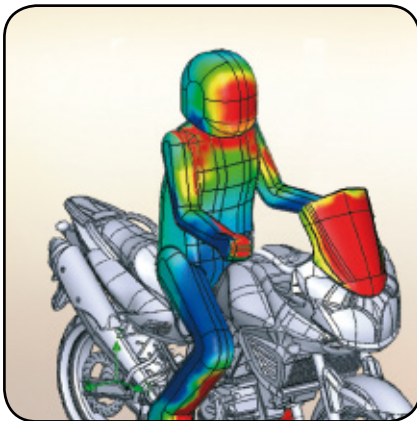

● Lower pressure
● Max. pressure
Wind pressure with a OEM screen.

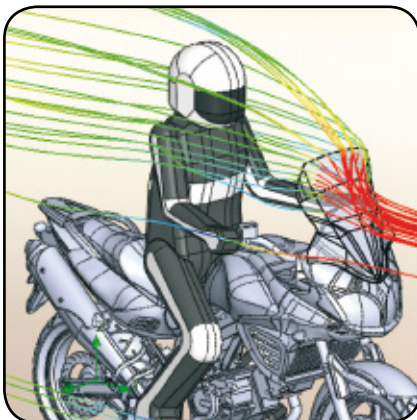

Improved aerodynamics and wind protection on average +12,7%.



Aerodynamic test delivered with almost all our screens. Check our website.



Aerodynamic test delivered with almost all our screens. Check our website.

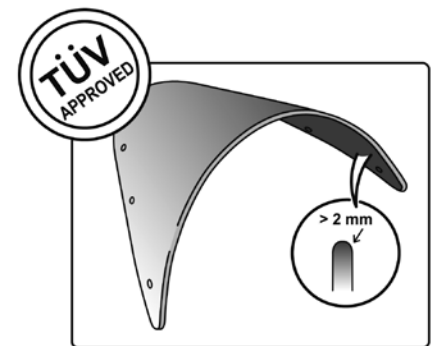

Rounded edge screen profile in >2 mm. complying with the German TÜV regulations.

MODEL	YEAR	TYPE OF WINDSCREEN	REF.	DIMENSIONS (Height x Width)	HEIGHT (MM) Compared to OEM	N H	W F	R V	T A	G C
LEONCINO TRAIL	17' - 18'	NAKED NEW GENERATION								
TORNADO 302R	14' - 18'	RACING	9591	373 x 340	+40			(*)		
TRK 502	16' - 18'	TOURING	9485	555 x 385	+110			(*)		
TRK 502	16' - 18'	TOURING WITH VISOR FIXED BY SCREWS	9508					(*)		
TRK 502	16' - 18'	TOURING WITH VISOR "CLIP ON"	9485 + 6375					(*)		
BMW										
F650GS	04' - 07'	TOURING	2015	440 x 305	+30			(*)		(*)
F650GS	08' - 12'	TOURING	4670	300 x 200	+120			(*)		(*)
F650GS	08' - 12'	TOURING WITH VISOR FIXED BY SCREWS	5914H					(*)		
F650GS	08' - 12'	TOURING WITH VISOR "CLIP ON"	4670 + 6320					(*)		
F650ST	93' - 00'	TOURING	0307	500 x 410	+70			(*)		(*)
F700GS	12' - 17'	TOURING	6365	490 x 400	+220			(*)		(*)
F700GS	12' - 17'	TOURING WITH VISOR FIXED BY SCREWS	6715H					(*)		
F700GS	12' - 17'	TOURING WITH VISOR "CLIP ON"	6365 + 6319					(*)		
F750GS	18'	TOURING	9770	530 x 412	+295			(*)		
F750GS	18'	TOURING WITH VISOR FIXED BY SCREWS	9771H					(*)		
F750GS	18'	TOURING WITH VISOR "CLIP ON"	(*)					(*)		
F800GT	13' - 18'	TOURING	6485	610 x 370	+140			(*)		(*)
F800GT	13' - 18'	TOURING WITH VISOR FIXED BY SCREWS	6503H					(*)		
F800GT	13' - 18'	TOURING WITH VISOR "CLIP ON"	6485 + 6375					(*)		
F800GS	08' - 17'	TOURING	4670	300 x 200	+120			(*)		(*)
F800GS	08' - 17'	TOURING WITH VISOR FIXED BY SCREWS	5914H					(*)		
F800GS	08' - 17'	TOURING WITH VISOR "CLIP ON"	4670 + 6320					(*)		
F800GS ADVENTURE	13' - 18'	TOURING	7307	370 x 345	+115			(*)		
F800R	09' - 14'	NAKED NEW GENERATION	SEE PAGE 56							
F800R	15' - 18'	NAKED NEW GENERATION	SEE PAGE 56							
F800S	06' - 11'	RACING	4376	390 x 330				(*)		(*)
F800ST	06' - 13'	RACING	4376	390 x 330				(*)		(*)
F850GS	18'	TOURING	9759H	530 x 412	+210			(*)		
F850GS	18'	TOURING WITH VISOR FIXED BY SCREWS	9760H					(*)		
F850GS	18'	TOURING WITH VISOR "CLIP ON"	(*)					(*)		
G310GS	17' - 18'	TOURING	9879	430 x 340	+180			(*)		
G310GS	17' - 18'	TOURING WITH VISOR FIXED BY SCREWS	9880					(*)		
G310GS	17' - 18'	TOURING WITH VISOR "CLIP ON"	9879 + 6320					(*)		
G310R	16' - 18'	NAKED NEW GENERATION	SEE PAGE 56							
G650GS	10'	TOURING	2015	440 x 305	+30			(*)		(*)
G650GS	11' - 16'	TOURING	5649 (-)	420 x 450	+205			(*)		
G650GS	11' - 16'	TOURING WITH VISOR FIXED BY SCREWS	5915 (-)					(*)		
G650GS	11' - 16'	TOURING WITH VISOR "CLIP ON"	5649 + 6319					(*)		
K1200R SPORT	07' - 08'	RACING	4669	360 x 450				(*)		(*)
K1200S	04' - 08'	RACING	2207	430 x 430				(*)		(*)

ANODIZED ALUMINIUM SCREWS AVAILABLE ON PAGE 442

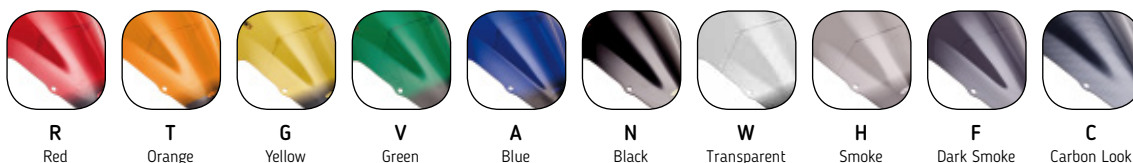

(*) Check price with your distributor.

(-) Adjustable in width and height.

(Z) Z-RACING design. For more information see our website.

(R) R-RACER design. For more information see our website.

CARBON LOOK: Racing screen available only.

NOTE COLORS: F and N colors delivered without silk print.

IMPORTANT: Indicate code color after part#. Example: 0973A.

WINDSCREENS FOR FAIRING BIKES

HI-TECH PARTS | TYPE OF WINDSCREEN:

2019
MODELS:
www.puig.tv



STANDARD

Shape that duplicates the stock screen.



RACING

Derived of competition their double height diminishes the air effect on helmet.



NAKED NEW GENERATION

Designed exclusively for each naked bike model.



TOURING

Its superior height improves protection and rider comfort.



TOURING SCREEN WITH VISOR BOLT-ON

The multi-adjustable visor incorporated allows to vary the effect of air on the pilot.



TOURING SCREEN WITH CLIP-ON VISOR

The multi-adjustable visor clip-on allows to vary the effect of air on the pilot.

MODEL	YEAR	TYPE OF WINDSCREEN	REF.	DIMENSIONS (Height x Width)	HEIGHT (MM) Compared to OEM	N H	W F	R V	T A	G C
K1300R	09' - 16'	NAKED NEW GENERATION	SEE PAGE 56							
K1300S	09' - 16'	RACING	2207	430 x 430		(*)			(*)	
K1600 GT	11' - 18'	TOURING	9512	695 x 680	+105	(*)				
K1600 GT	11' - 18'	TOURING WITH VISOR FIXED BY SCREWS	9513H			(*)				
K1600 GT	11' - 18'	TOURING WITH VISOR "CLIP ON"	9512 + 6375			(*)				
K1600 GTL	11' - 18'	TOURING	9512	695 x 680	+105	(*)				
K1600 GTL	11' - 18'	TOURING WITH VISOR FIXED BY SCREWS	9513H			(*)				
K1600 GTL	11' - 18'	TOURING WITH VISOR "CLIP ON"	9512 + 6375			(*)				
K1600 GTL GRAND AMERICA	18'	TOURING	9512	695 x 680	+105	(*)				
K1600 GTL GRAND AMERICA	18'	TOURING WITH VISOR FIXED BY SCREWS	9513H			(*)				
K1600 GTL GRAND AMERICA	18'	TOURING WITH VISOR "CLIP ON"	9512 + 6375			(*)				
R NINE T RACER	17' - 18'	RACING	9402	385 x 360	+25	(*)				
R1100GS	94' - 99'	TOURING	0295	510 x 400	+100	(*)				
R1150GS	99' - 04'	TOURING	4878	540 x 430	+95	(*)				
R1150GS	99' - 04'	TOURING WITH VISOR FIXED BY SCREWS	5917H			(*)				
R1150GS	99' - 04'	TOURING WITH VISOR "CLIP ON"	4878 + 6375			(*)				
R1200GS	04' - 12'	TOURING	4331	530 x 460	+130	(*)				
R1200GS	04' - 12'	TOURING WITH VISOR FIXED BY SCREWS	5916H			(*)				
R1200GS	04' - 12'	TOURING WITH VISOR "CLIP ON"	4331 + 6319			(*)				
R1200GS	13' - 16'	ORIGINAL DEFLECTOR	7550	115 x 240		(*)				
R1200GS	13' - 18'	RACING	6487	320 x 340	-120	(*)				
R1200GS	13' - 18'	TOURING	6486	545 x 585	+110	(*)			(*)	
R1200GS	13' - 18'	TOURING WITH VISOR FIXED BY SCREWS	6504H			(*)				
R1200GS	13' - 18'	TOURING WITH VISOR "CLIP ON"	6486 + 6375			(*)				
R1200GS	13' - 18'	FIXING BRACKET Part# 6486	7566N			(*)				
R1250GS	18'	RACING	6487	320 x 340	-120	(*)				
R1250GS	18'	TOURING	6486	545 x 585	+110	(*)			(*)	
R1250GS	18'	TOURING WITH VISOR FIXED BY SCREWS	6504H			(*)				
R1250GS	18'	TOURING WITH VISOR "CLIP ON"	6486 + 6375			(*)				
R1250GS	18'	FIXING BRACKET Part# 6486	7566N			(*)				
R1200GS EXCLUSIVE	17' - 18'	RACING	6487	320 x 340		(*)				
R1200GS EXCLUSIVE	17' - 18'	TOURING	6486	545 x 585		(*)				
R1200GS EXCLUSIVE	17' - 18'	TOURING WITH VISOR FIXED BY SCREWS	6504H			(*)				
R1200GS EXCLUSIVE	17' - 18'	TOURING WITH VISOR "CLIP ON"	6486 + 6375			(*)				
R1200GS EXCLUSIVE	17' - 18'	FIXING BRACKET Part# 6486	7566N			(*)				

MODEL	YEAR	TYPE OF WINDSCREEN	REF.	DIMENSIONS (Height x Width)	HEIGHT (MM) Compared to OEM	N H	W F	R V	T A	G C
R1200GS RALLYE	17' - 18'	RACING	6487	320 x 340				(*)		
R1200GS RALLYE	17' - 18'	TOURING	6486	545 x 585				(*)		
R1200GS RALLYE	17' - 18'	TOURING WITH VISOR FIXED BY SCREWS	6504H					(*)		
R1200GS RALLYE	17' - 18'	TOURING WITH VISOR "CLIP ON"	6486 + 6375					(*)		
R1200GS RALLYE	17' - 18'	FIXING BRACKET Part# 6486	7566N					(*)		
R1200GS ADVENTURE	14' - 18'	RACING	6487	320 x 340	-120			(*)		
R1200GS ADVENTURE	14' - 18'	TOURING	6486	545 x 585	+110			(*)		
R1200GS ADVENTURE	14' - 18'	TOURING WITH VISOR FIXED BY SCREWS	6504H					(*)		
R1200GS ADVENTURE	14' - 18'	TOURING WITH VISOR "CLIP ON"	6486 + 6375					(*)		
R1200GS ADVENTURE	14' - 18'	FIXING BRACKET Part# 6486	7566N					(*)		
R1200GS ADVENTURE	14' - 16'	ORIGINAL DEFLECTOR	7550	115 x 240				(*)		
R1200R	06' - 14'	NAKED NEW GENERATION	SEE PAGE 56							
R1200R	15' - 18'	NAKED NEW GENERATION	SEE PAGE 56							
R1200RS	15' - 18'	RACING	7616	440 x 390	+20			(*)	(*)	
R1200RS	15' - 18'	TOURING	7617	550 x 410	+95			(*)		
R1200RS	15' - 18'	TOURING WITH VISOR FIXED BY SCREWS	7618H					(*)		
R1200RS	15' - 18'	TOURING WITH VISOR "CLIP ON"	7617 + 6320					(*)		
R1200RT	14' - 18'	TOURING	9512	695 x 680	+110			(*)		
R1200RT	14' - 18'	TOURING WITH VISOR FIXED BY SCREWS	9513H					(*)		
R1200RT	14' - 18'	TOURING WITH VISOR "CLIP ON"	9512 + 6375					(*)		
R1200S	06' - 08'	RACING	4375	340 x 340						(*)
S1000R	14' - 18'	NAKED NEW GENERATION	SEE PAGE 56							
S1000RR	09' - 14'	RACING	(Z) 5205	430 x 300				(*)	(*)	
S1000RR	15' - 18'	RACING	(Z) 7564	360 x 440	+30			(*)	(*)	
S1000XR	15' - 18'	RACING	8543	390 x 345	-30			(*)	(*)	
S1000XR	15' - 18'	TOURING	7619	515 x 425	+105			(*)		
S1000XR	15' - 18'	TOURING WITH VISOR FIXED BY SCREWS	7620H					(*)		
S1000XR	15' - 18'	TOURING WITH VISOR "CLIP ON"	7619 + 6320					(*)		
DUCATI										
749/749S/999/999S	03' - 04'	RACING	1349	410 x 320				(*)	(*)	
749R/749/749S/999/999S/999R	05' - 06'	RACING	2541	420 x 330						(*)
916S/996/998/748		RACING	0955	340 x 310						(*)
848	08' - 10'	RACING	4667	435 x 330				(*)	(*)	
899 PANIGALE	14' - 15'	RACING	(R) 5990	400 x 250				(*)		
959 PANIGALE	16' - 18'	RACING	(R) 7621	370 x 250	+30			(*)	(*)	
959 PANIGALE CORSE	18'	RACING	(R) 7621	370 x 250	+30			(*)	(*)	
1098/1098R/1098S	07' - 08'	RACING	4667	435 x 330				(*)	(*)	
1198/1198R/1198S	09' - 11'	RACING	4667	435 x 330				(*)	(*)	
1199 PANIGALE	12' - 14'	RACING	(R) 5990	400 x 250				(*)		
1199 PANIGALE R	15' - 17'	RACING	(R) 5990	400 x 250				(*)		
1199 SUPERLEGGERA	14'	RACING	(R) 5990	400 x 250				(*)		

ANODIZED ALUMINIUM SCREWS AVAILABLE ON PAGE 442

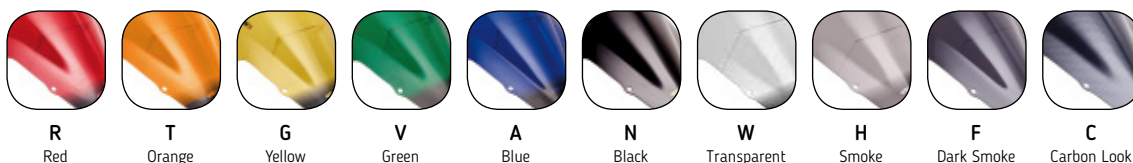

(*) Check price with your distributor.

(-) Adjustable in width and height.

(Z) Z-RACING design. For more information see our website.

(R) R-RACER design. For more information see our website.

CARBON LOOK: Racing screen available only.

NOTE COLORS: F and N colors delivered without silk print.

IMPORTANT: Indicate code color after part#. Example: 0973A.

WINDSCREENS FOR FAIRING BIKES

HI-TECH PARTS | TYPE OF WINDSCREEN:

2019
MODELS:
www.puig.tv



STANDARD

Shape that duplicates the stock screen.



RACING

Derived of competition their double height diminishes the air effect on helmet.



NAKED NEW GENERATION

Designed exclusively for each naked bike model.



TOURING

Its superior height improves protection and rider comfort.



TOURING SCREEN WITH VISOR BOLT-ON

The multi-adjustable visor incorporated allows to vary the effect of air on the pilot.



TOURING SCREEN WITH CLIP-ON VISOR

The multi-adjustable visor clip-on allows to vary the effect of air on the pilot.

MODEL	YEAR	TYPE OF WINDSCREEN	REF.	DIMENSIONS (Height x Width)	HEIGHT (MM) Compared to OEM	N H	W F	R V	T A	G C
1299 PANIGALE/S	15' - 17'	RACING	(R) 7621	370 x 250	+30	(*)	(*)			
PANIGALE V4	18'	RACING	9690	400 x 275	+30	(*)	(*)			
PANIGALE V4S	18'	RACING	9690	400 x 275	+30	(*)	(*)			
PANIGALE V4 SPECIALE	18'	RACING	9690	400 x 275	+30	(*)	(*)			
DIAVEL	11' - 18'	NAKED NEW GENERATION	SEE PAGE 57							
X DIAVEL/S	16' - 18'	NAKED NEW GENERATION	SEE PAGE 57							
HYPERMOTARD 796	10' - 13'	NAKED NEW GENERATION	SEE PAGE 57							
HYPERMOTARD 1100	07' - 09'	NAKED NEW GENERATION	SEE PAGE 57							
HYPERMOTARD 1100 S	10' - 12'	NAKED NEW GENERATION	SEE PAGE 57							
HYPERMOTARD 821/SP	13' - 15'	NAKED NEW GENERATION	SEE PAGE 57							
HYPERMOTARD 939/SP	16' - 18'	NAKED NEW GENERATION	SEE PAGE 57							
HYPERSTRADA	13' - 15'	TOURING	6492	450 x 320	+75	(*)	(*)			
HYPERSTRADA 939	16' - 17'	TOURING	6492	450 x 320	+75	(*)	(*)			
MONSTER 696	08' - 14'	NAKED NEW GENERATION	SEE PAGE 57							
MONSTER 796	10' - 14'	NAKED NEW GENERATION	SEE PAGE 57							
MONSTER 797	17' - 18'	NAKED NEW GENERATION	SEE PAGE 57							
MONSTER 821	14' - 18'	NAKED NEW GENERATION	SEE PAGE 57							
MONSTER 1100/S	09' - 10'	NAKED NEW GENERATION	SEE PAGE 57							
MONSTER 1100 EVO	11' - 13'	NAKED NEW GENERATION	SEE PAGE 57							
MONSTER 1200/S	14' - 18'	NAKED NEW GENERATION	SEE PAGE 57							
MONSTER 1200 R	16' - 18'	NAKED NEW GENERATION	SEE PAGE 57							
MULTISTRADA 950	17' - 18'	RACING	7622	440 x 295	-80	(*)	(*)			
MULTISTRADA 950	17' - 18'	TOURING	7623	605 x 335	+85	(*)	(*)			
MULTISTRADA 950	17' - 18'	TOURING WITH VISOR FIXED BY SCREWS	7624H			(*)	(*)			
MULTISTRADA 950	17' - 18'	TOURING WITH VISOR "CLIP ON"	7623 + 6319			(*)	(*)			
MULTISTRADA 1200/S	10' - 12'	RACING	6273	390 x 290	+65	(*)	(*)			
MULTISTRADA 1200/S	10' - 12'	TOURING	5250	573 x 330	+65	(*)	(*)			
MULTISTRADA 1200/S	13' - 14'	RACING	6490	430 x 290	-85	(*)	(*)			
MULTISTRADA 1200/S	13' - 14'	TOURING	6491	580 x 405	+65	(*)	(*)			
MULTISTRADA 1200/S	13' - 14'	TOURING WITH VISOR FIXED BY SCREWS	6505H			(*)	(*)			
MULTISTRADA 1200/S	13' - 14'	TOURING WITH VISOR "CLIP ON"	6491 + 6320			(*)	(*)			
MULTISTRADA 1200/S	15' - 17'	RACING	7622	440 x 295	-80	(*)	(*)			
MULTISTRADA 1200/S	15' - 17'	TOURING	7623	605 x 335	+85	(*)	(*)			
MULTISTRADA 1200/S	15' - 17'	TOURING WITH VISOR FIXED BY SCREWS	7624H			(*)	(*)			
MULTISTRADA 1200/S	15' - 17'	TOURING WITH VISOR "CLIP ON"	7623 + 6319			(*)	(*)			

MODEL	YEAR	TYPE OF WINDSCREEN	REF.	DIMENSIONS (Height x Width)	HEIGHT (MM) Compared to OEM	N H	W F	R V	T A	G C
MULTISTRADA 1200 ENDURO/PRO	16' - 18'	RACING	7622	440 x 295	-80	(*)	(*)			
MULTISTRADA 1200 ENDURO/PRO	16' - 18'	TOURING	7623	605 x 335	+85	(*)				
MULTISTRADA 1200 ENDURO/PRO	16' - 18'	TOURING WITH VISOR FIXED BY SCREWS	7624H			(*)				
MULTISTRADA 1200 ENDURO/PRO	16' - 18'	TOURING WITH VISOR "CLIP ON"	7623 + 6319			(*)				
MULTISTRADA 1260/S/S DJAIR	18'	RACING	7622	440 x 295	-80	(*)	(*)			
MULTISTRADA 1260/S/S DJAIR	18'	TOURING	7623	605 x 335	+85	(*)				
MULTISTRADA 1260/S/S DJAIR	18'	TOURING WITH VISOR FIXED BY SCREWS	7624H			(*)				
MULTISTRADA 1260/S/S DJAIR	18'	TOURING WITH VISOR "CLIP ON"	7623 + 6319			(*)				
MULTISTRADA 1260 PIKES PEAK	18'	RACING	7622	440 x 295	-80	(*)	(*)			
MULTISTRADA 1260 PIKES PEAK	18'	TOURING	7623	605 x 335	+85	(*)				
MULTISTRADA 1260 PIKES PEAK	18'	TOURING WITH VISOR FIXED BY SCREWS	7624H			(*)				
MULTISTRADA 1260 PIKES PEAK	18'	TOURING WITH VISOR "CLIP ON"	7623 + 6319			(*)				
Original fairing MONSTER 696/796/1100		STANDARD	5890	160 x 220		(*)				
Original fairing MONSTER 696/796/1100		RACING	5650	260 x 220	+100	(*)	(*)			
STREETFIGHTER 848	12' - 15'	NAKED NEW GENERATION	SEE PAGE 57							
STREETFIGHTER 1100/S	09' - 12'	NAKED NEW GENERATION	SEE PAGE 57							
SUPERSPORT 939/S	17' - 18'	TOURING	9434	405 x 290	+75	(*)				
HARLEY DAVIDSON										
SPORTSTER 883		NAKED NEW GENERATION	SEE PAGE 57							
SPORTSTER 1200		NAKED NEW GENERATION	SEE PAGE 57							
HONDA										
CB125F	15' - 18'	NAKED NEW GENERATION	SEE PAGE 58							
CB125R NEO SPORTS CAFE	18'	NAKED NEW GENERATION								
CB300F	15' - 16'	NAKED NEW GENERATION	SEE PAGE 58							
CB300R NEO SPORTS CAFE	18'	NAKED NEW GENERATION								
CB500F	13' - 18'	NAKED NEW GENERATION	SEE PAGE 58							
CB500X	13' - 15'	TOURING	6480	485 x 350	+165	(*)				
CB500X	13' - 15'	TOURING WITH VISOR FIXED BY SCREWS	6992H			(*)				
CB500X	13' - 15'	TOURING WITH VISOR "CLIP ON"	6480 + 6319			(*)				
CB500X	16' - 18'	TOURING	8901	520 x 310	+105	(*)	(*)			
CB500X	16' - 18'	TOURING WITH VISOR FIXED BY SCREWS	8902H			(*)				
CB500X	16' - 18'	TOURING WITH VISOR "CLIP ON"	8901 + 6319			(*)				
CMX 500 REBEL	17' - 18'	NAKED NEW GENERATION	SEE PAGE 58							
CB600F HORNET	05' - 06'	NAKED NEW GENERATION	SEE PAGE 58							
CB600F HORNET	07' - 10'	NAKED NEW GENERATION	SEE PAGE 58							
CB600F HORNET	11' - 15'	NAKED NEW GENERATION	SEE PAGE 58							
CB650F	14' - 18'	NAKED NEW GENERATION	SEE PAGE 58							
CB1000R	08' - 10'	NAKED NEW GENERATION	SEE PAGE 58							
CB1000R	11' - 16'	NAKED NEW GENERATION	SEE PAGE 58							
CB1000R NEO SPORTS CAFE	18'	NAKED NEW GENERATION	SEE PAGE 58							
CB1300S	05' - 13'	TOURING	4098	470 x 320	+100	(*)	(*)			

ANODIZED ALUMINIUM SCREWS AVAILABLE ON PAGE 442

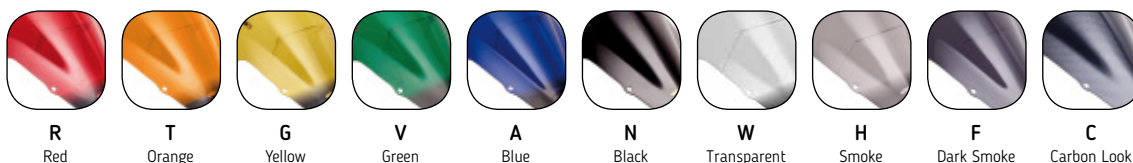

(*) Check price with your distributor.

(-) Adjustable in width and height.

(Z) Z-RACING design. For more information see our website.

(R) R-RACER design. For more information see our website.

CARBON LOOK: Racing screen available only.

NOTE COLORS: F and N colors delivered without silk print.

IMPORTANT: Indicate code color after part#. Example: 0973A.

WINDSCREENS FOR FAIRING BIKES

HI-TECH PARTS | TYPE OF WINDSCREEN:

2019
MODELS:
www.puig.tv



STANDARD

Shape that duplicates the stock screen.



RACING

Derived of competition their double height diminishes the air effect on helmet.



NAKED NEW GENERATION

Designed exclusively for each naked bike model.



TOURING

Its superior height improves protection and rider comfort.



TOURING SCREEN WITH VISOR BOLT-ON

The multi-adjustable visor incorporated allows to vary the effect of air on the pilot.



TOURING SCREEN WITH CLIP-ON VISOR

The multi-adjustable visor clip-on allows to vary the effect of air on the pilot.

MODEL	YEAR	TYPE OF WINDSCREEN	REF.	DIMENSIONS (Height x Width)	HEIGHT (MM) Compared to OEM	N H	W F	R V	T A	G C
CB1300S	05' - 13'	TOURING WITH VISOR FIXED BY SCREWS	5900H			(*)				
CB1300S	05' - 13'	TOURING WITH VISOR "CLIP ON"	4098 + 6319			(*)				
CBF600S	04' - 14'	TOURING WITH VISOR FIXED BY SCREWS	5898H			(*)				
CBF600S	04' - 14'	TOURING WITH VISOR "CLIP ON"	1661 + 6320			(*)				
CBF1000F	10' - 16'	TOURING	5252	470 x 340	+100	(*)				
CBF1000F	10' - 16'	TOURING WITH VISOR FIXED BY SCREWS	5899H			(*)				
CBF1000F	10' - 16'	TOURING WITH VISOR "CLIP ON"	5252 + 6320			(*)				
CBR600F	01' - 07'	RACING	0861	400 x 370		(*)			(*)	
CBR600F	11' - 13'	RACING	(Z) 5637	370 x 300		(*)			(*)	
CBR650F	14' - 18'	RACING	(Z) 7003	355 x 310	+30	(*)			(*)	
CBR650F	14' - 18'	TOURING	7595	435 x 375	+110	(*)				
CBR650F	14' - 18'	TOURING WITH VISOR FIXED BY SCREWS	7601H			(*)				
CBR650F	14' - 18'	TOURING WITH VISOR "CLIP ON"	7595 + 6320			(*)				
CBR125R	07' - 10'	RACING	4378	270 x 250		(*)				
CBR125R	11' - 16'	RACING	(Z) 5641	420 x 280		(*)			(*)	
CBR250R	11' - 15'	RACING	(Z) 5643	420 x 340		(*)			(*)	
CBR300R	15' - 17'	RACING	(Z) 7228	315 x 240		(*)			(*)	
CBR500R	13' - 15'	RACING	(Z) 6479	315 X 285	+40	(*)			(*)	
CBR500R	16' - 18'	RACING	(Z) 8903	330 x 275	+30	(*)			(*)	
CBR600RR	03' - 04'	RACING	1332	300 x 320	+30	(*)			(*)	
CBR600RR	05' - 06'	RACING	2058	280 x 320		(*)			(*)	
CBR600RR	07' - 12'	RACING	4356	340 x 315		(*)			(*)	
CBR600RR	13' - 16'	RACING	(Z) 6478	240 x 280	+30	(*)			(*)	
CBR900RR FIRE BLADE	02' - 03'	RACING	1100	320 x 400		(*)				
CBR1000RR FIRE BLADE	04' - 07'	RACING	(Z) 1665	370 x 330	+25	(*)			(*)	
CBR1000RR FIRE BLADE	08' - 11'	STANDARD	4622	290 x 300		(*)			(*)	
CBR1000RR FIRE BLADE	08' - 11'	RACING	4623	290 x 285		(*)			(*)	
CBR1000RR FIRE BLADE	12' - 13'	RACING	(Z) 5994	340 x 300	+40	(*)			(*)	
CBR1000RR FIREBLADE/SP	14' - 16'	RACING	(Z) 5994	340 x 300	+40	(*)			(*)	
CBR1000RR FIREBLADE/SP/SP2	17' - 18'	RACING	9407	330 x 245	+30	(*)			(*)	
CBR1100XX BLACKBIRD	97' - 07'	RACING	0283	450 x 445		(*)				
CBR1100XX BLACKBIRD	97' - 07'	TOURING	0028	470 x 415	+51					(*)
CRF1000L AFRICA TWIN	16' - 18'	SUPPORT + PROTECTION	9154N		+80	(*)				
CRF1000L AFRICA TWIN	16' - 18'	RACING	8904	415 x 290	-50	(*)			(*)	
CRF1000L AFRICA TWIN	16' - 18'	RACING WITH SUPPORT + PROTECTION	9155	415 x 290	+30	(*)			(*)	

MODEL	YEAR	TYPE OF WINDSCREEN	REF.	DIMENSIONS (Height x Width)	HEIGHT (MM) Compared to OEM	N H	W F	R V	T A	G C
CRF1000L AFRICA TWIN	16' - 18'	TOURING	8905	590 x 355	+90	(*)	(*)			
CRF1000L AFRICA TWIN	16' - 18'	TOURING WITH SUPPORT + PROTECTION	9156	590 x 355	+170	(*)	(*)			
CRF1000L AFRICA TWIN	16' - 18'	TOURING WITH VISOR FIXED BY SCREWS	8906			(*)				
CRF1000L AFRICA TWIN	16' - 18'	TOURING WITH VISOR "CLIP ON"	8905 + 6319			(*)				
CRF1000L AFRICA TWIN	16' - 18'	TOURING WITH VISOR FIXED BY SCREWS WITH SUPPORT + PROTECTION	9157			(*)				
CRF1000L AFRICA TWIN	16' - 18'	TOURING WITH VISOR "CLIP ON" WITH SUPPORT + PROT.	9157 + 6319			(*)				
CRF1000L AFRICA TWIN ADVENTURE SPORTS	18'	SUPPORT + PROTECTION	9154N		+80	(*)				
CRF1000L AFRICA TWIN ADVENTURE SPORTS	18'	RACING	8904	415 x 290	-135	(*)	(*)			
CRF1000L AFRICA TWIN ADVENTURE SPORTS	18'	RACING WITH SUPPORT + PROTECTION	9155	415 x 290	-60	(*)	(*)			
CRF1000L AFRICA TWIN ADVENTURE SPORTS	18'	TOURING	8905	590 x 355	+100	(*)	(*)			
CRF1000L AFRICA TWIN ADVENTURE SPORTS	18'	TOURING WITH SUPPORT + PROTECTION	9156	590 x 355	+85	(*)	(*)			
CRF1000L AFRICA TWIN ADVENTURE SPORTS	18'	TOURING WITH VISOR FIXED BY SCREWS	8906			(*)				
CRF1000L AFRICA TWIN ADVENTURE SPORTS	18'	TOURING WITH VISOR "CLIP ON"	8905 + 6319			(*)				
CRF1000L AFRICA TWIN ADVENTURE SPORTS	18'	TOURING WITH VISOR WITH SUPPORT + PROTECTION	9157			(*)				
CRF1000L AFRICA TWIN ADVENTURE SPORTS	18'	TOURING WITH VISOR "CLIP ON" WITH SUPPORT + PROT.	9157 + 6319			(*)				
CROSSRUNNER	11' - 14'	TOURING	5639	480 x 470	+180	(*)	(*)			
CROSSRUNNER	15' - 16'	TOURING	7626	570 x 435	+150	(*)				
CROSSRUNNER	15' - 16'	TOURING WITH VISOR FIXED BY SCREWS	7627H			(*)				
CROSSRUNNER	15' - 16'	TOURING WITH VISOR "CLIP ON"	7626 + 6375			(*)				
CROSSRUNNER	17' - 18'	TOURING	9444	570 x 435	+150	(*)				
CROSSRUNNER	17' - 18'	TOURING WITH VISOR FIXED BY SCREWS	9445H			(*)				
CROSSRUNNER	17' - 18'	TOURING WITH VISOR "CLIP ON"	9444 + 6375			(*)				
CROSSTOURER	12' - 15'	TOURING	5993	510 x 470	+165	(*)				
CROSSTOURER	12' - 15'	TOURING WITH VISOR FIXED BY SCREWS	6003H			(*)				
CROSSTOURER	12' - 15'	TOURING WITH VISOR "CLIP ON"	5993 + 6375			(*)				
CTX700	14' - 16'	TOURING	7227	510 x 580	+280	(*)				
CTX700N	14' - 16'	NAKED NEW GENERATION	SEE PAGE 58							
CTX1300	14' - 16'	TOURING	7005	580 x 570	+325	(*)				
CTX1300	14' - 16'	TOURING WITH VISOR FIXED BY SCREWS	7006H			(*)				
CTX1300	14' - 16'	TOURING WITH VISOR "CLIP ON"	7005 + 6375			(*)				
NC700S	12' - 13'	RACING	5991	340 x 295	+285	(*)	(*)			
NC700S	12' - 13'	TOURING	6361	430 x 320	+285	(*)	(*)			
NC700S	12' - 13'	TOURING WITH VISOR FIXED BY SCREWS	6001H			(*)				
NC700S	12' - 13'	TOURING WITH VISOR "CLIP ON"	6361 + 6319			(*)				
NC750S	14' - 18'	RACING	5991	340 x 295	+285	(*)	(*)			
NC750S	14' - 18'	TOURING	6361	430 x 320	+285	(*)	(*)			
NC750S	14' - 18'	TOURING WITH VISOR FIXED BY SCREWS	6001H			(*)				
NC750S	14' - 18'	TOURING WITH VISOR "CLIP ON"	6361 + 6319			(*)				
NC700X	12' - 13'	TOURING	5992	480 x 420	+150	(*)				
NC700X	12' - 13'	TOURING WITH VISOR FIXED BY SCREWS	6002H			(*)				

ANODIZED ALUMINIUM SCREWS AVAILABLE ON PAGE 442

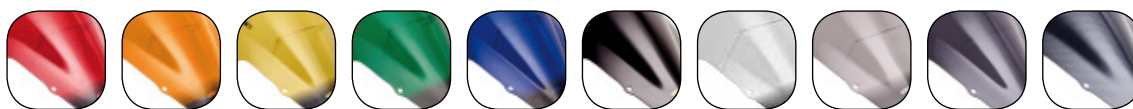

R Red T Orange G Yellow V Green A Blue N Black W Transparent H Smoke F Dark Smoke C Carbon Look

(*) Check price with your distributor.

(-) Adjustable in width and height.

(Z) Z-RACING design. For more information see our website.

(R) R-RACER design. For more information see our website.

CARBON LOOK: Racing screen available only.

NOTE COLORS: F and N colors delivered without silk print.

IMPORTANT: Indicate code color after part#. Example: 0973A.

WINDSCREENS FOR FAIRING BIKES

HI-TECH PARTS | TYPE OF WINDSCREEN:

2019
MODELS:
www.puig.tv



STANDARD

Shape that duplicates the stock screen.



RACING

Derived of competition their double height diminishes the air effect on helmet.

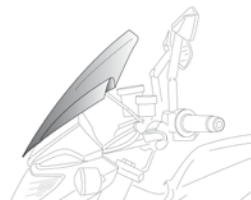

NAKED NEW GENERATION

Designed exclusively for each naked bike model.



TOURING

Its superior height improves protection and rider comfort.



TOURING SCREEN WITH VISOR BOLT-ON

The multi-adjustable visor incorporated allows to vary the effect of air on the pilot.



TOURING SCREEN WITH CLIP-ON VISOR

The multi-adjustable visor clip-on allows to vary the effect of air on the pilot.

MODEL	YEAR	TYPE OF WINDSCREEN	REF.	DIMENSIONS (Height x Width)	HEIGHT (MM) Compared to OEM	N H	W F	R V	T A	G C
NC700X	12' - 13'	TOURING WITH VISOR "CLIP ON"	5992 + 6319			(*)				
NC750X	14' -15'	TOURING	5992	480 x 420	+150	(*)				
NC750X	14' -15'	TOURING WITH VISOR FIXED BY SCREWS	6002H			(*)				
NC750X	14' -15'	TOURING WITH VISOR "CLIP ON"	5992 + 6319			(*)				
NC750X	16' - 18'	RACING	8909	300 x 270	-110	(*)				
NC750X	16' - 18'	TOURING	8910	520 x 325	+115	(*)			(*)	
NC750X	16' - 18'	TOURING WITH VISOR FIXED BY SCREWS	8911H			(*)				
NC750X	16' - 18'	TOURING WITH VISOR "CLIP ON"	8910 + 6320			(*)				
NT650V DEAUVILLE	98' - 05'	TOURING	0414	550 x 380	+210	(*)				
PAN-EUROPEAN	02' - 13'	TOURING	5995	590 x 630	+70	(*)			(*)	
PAN-EUROPEAN	02' - 13'	TOURING WITH VISOR FIXED BY SCREWS	7591H			(*)				
PAN-EUROPEAN	02' - 13'	TOURING WITH VISOR "CLIP ON"	5995 + 6375			(*)				
ST1100 PAN EUROPEAN	90' - 01'	TOURING	0190	560 x 520	+125	(*)				
ST1100 PAN EUROPEAN	90' - 01'	TOURING WITH VISOR FIXED BY SCREWS	5902H			(*)				
ST1100 PAN EUROPEAN	90' - 01'	TOURING WITH VISOR "CLIP ON"	0190 + 6375			(*)				
VFR800	02' - 13'	RACING	1097	390 x 390		(*)				
VFR800F	14' - 18'	RACING	(Z) 7598	435 x 340	+30	(*)			(*)	
VFR800F	14' - 18'	TOURING	7007	540 x 400	+130	(*)				
VFR800F	14' - 18'	TOURING WITH VISOR FIXED BY SCREWS	7008H			(*)				
VFR800F	14' - 18'	TOURING WITH VISOR "CLIP ON"	7007 + 6320			(*)				
VFR1200F	10' - 16'	RACING	(Z) 5251	450 X 410	+30	(*)			(*)	
VTR1000F FIRE STORM	97' - 07'	RACING	0964	380 x 345					(*)	
VTR1000 SP-1	00' - 02'	RACING	0340	300 x 315		(*)				
VTR1000 SP-2	02' - 05'	RACING	0340	300 x 315		(*)				
XL650V TRANSALP	00' - 07'	TOURING	0377	530 x 380	+165	(*)			(*)	
XL1000V VARADERO	03' - 11'	TOURING	1635	600 x 380	+100	(*)			(*)	
XL1000V VARADERO	03' - 11'	TOURING WITH VISOR FIXED BY SCREWS	5903H			(*)				
XL1000V VARADERO	03' - 11'	TOURING WITH VISOR "CLIP ON"	1635 + 6320			(*)				
X-ADV	17' - 18'	TOURING	9709	655 x 430	+115	(*)				
X-ADV	17' - 18'	TOURING WITH VISOR FIXED BY SCREWS	9712			(*)				
X-ADV	17' - 18'	TOURING WITH VISOR "CLIP ON"	9709 + 6320			(*)				
HUSQVARNA										
NUDA 900/R	12' - 14'	NAKED NEW GENERATION	SEE PAGE 58							
701 ENDURO	16' - 18'	NAKED NEW GENERATION	SEE PAGE 58							
SVARTPILEN 401	17' - 18'	NAKED NEW GENERATION	SEE PAGE 58							

MODEL	YEAR	TYPE OF WINDSCREEN	REF.	DIMENSIONS (Height x Width)	HEIGHT (MM) Compared to OEM	N H	W F	R V	T A	G C
VITPILEN 401	17' - 18'	NAKED NEW GENERATION	SEE PAGE 58							
VITPILEN 701	18'	NAKED NEW GENERATION	SEE PAGE 58							
HYOSUNG										
GT125R	06' - 13'	RACING	4184	370 x 365		(*)				(*)
GT250Ri	06' - 18'	RACING	4184	370 x 365		(*)				(*)
GT650R	05' - 17'	RACING	4184	370 x 365		(*)				(*)
GT650Ri	13' - 18'	RACING	(Z) 6716	385 x 355	+55	(*)				(*)
INDIAN										
SCOUT	15' - 18'	NAKED NEW GENERATION	SEE PAGE 58							
KAWASAKI										
ER-6F	06' - 08'	RACING	(Z) 4106	415 x 355	+40	(*)				(*)
ER-6F	09' - 11'	RACING	4931	460 x 330		(*)				(*)
ER-6F	12' - 16'	TOURING	5998	540 x 450	+10	(*)				(*)
ER-6F	12' - 16'	TOURING WITH VISOR FIXED BY SCREWS	6004H			(*)				
ER-6F	12' - 16'	TOURING WITH VISOR "CLIP ON"	5998 + 6375			(*)				
ER-6N	05' - 08'	NAKED NEW GENERATION	SEE PAGE 58							
ER-6N	09' - 11'	NAKED NEW GENERATION	SEE PAGE 58							
ER-6N	12' - 16'	NAKED NEW GENERATION	SEE PAGE 58							
GTR1400	07' - 09'	TOURING	4619	680 x 570	+160	(*)				
GTR1400	07' - 09'	TOURING WITH VISOR FIXED BY SCREWS	5904H			(*)				
GTR1400	07' - 09'	TOURING WITH VISOR "CLIP ON"	4619 + 6375			(*)				
GTR1400	10' - 14'	TOURING	4619	680 x 570		(*)				
GTR1400	10' - 14'	TOURING WITH VISOR FIXED BY SCREWS	5904H			(*)				
GTR1400	10' - 14'	TOURING WITH VISOR "CLIP ON"	4619 + 6375			(*)				
GTR1400	15' - 17'	TOURING	7628	705 x 580	+105	(*)				
GTR1400	15' - 17'	TOURING WITH VISOR FIXED BY SCREWS	7629H			(*)				
GTR1400	15' - 17'	TOURING WITH VISOR "CLIP ON"	7628 + 6375			(*)				
KLE500	05' - 07'	RACING	1520	430 x 270		(*)				
KLV1000	04' - 05'	TOURING	1880	515 x 415	+120	(*)				(*)
NINJA 250R	08' - 12'	RACING	4626	340 x 325		(*)				(*)
NINJA 250SL	15' - 16'	RACING	(Z) 7630	345 x 270	+65	(*)				
NINJA 300	13' - 17'	RACING	(Z) 6463	415 x 355	+40	(*)				(*)
NINJA 400	18'	RACING	(Z) 9976	400 x 335	+30	(*)				(*)
NINJA 650	17' - 18'	RACING	9711	450 x 310	+65	(*)				
NINJA H2/H2R	15' - 18'	RACING	(Z) 7631	330 x 330	+30	(*)				
NINJA H2 SX	18'	RACING	9704	400 x 390	+15	(*)				(*)
VERSYS-X 300	17' - 18'	TOURING	9710	520 x 310	+115	(*)				
VERSYS-X 300	17' - 18'	TOURING WITH VISOR FIXED BY SCREWS	9713			(*)				
VERSYS-X 300	17' - 18'	TOURING WITH VISOR "CLIP ON"	9710 + 5852			(*)				
VERSYS 650	07' - 09'	TOURING	4360	370 x 340	+75	(*)				(*)
VERSYS 650	10' - 14'	TOURING	5255	400 x 315	+60	(*)				

ANODIZED ALUMINIUM SCREWS AVAILABLE ON PAGE 442

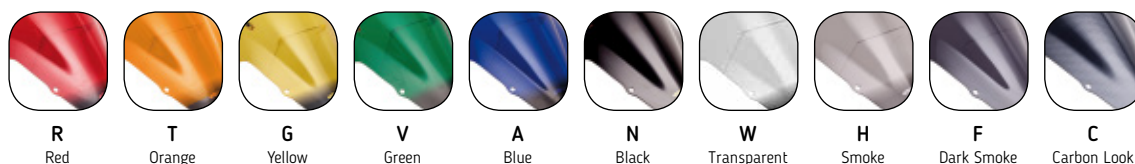

(*) Check price with your distributor.

(-) Adjustable in width and height.

(Z) Z-RACING design. For more information see our website.

(R) R-RACER design. For more information see our website.

CARBON LOOK: Racing screen available only.

NOTE COLORS: F and N colors delivered without silk print.

IMPORTANT: Indicate code color after part#. Example: 0973A.

WINDSCREENS FOR FAIRING BIKES

HI-TECH PARTS | TYPE OF WINDSCREEN:

2019
MODELS:
www.puig.tv

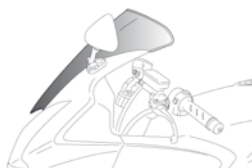

STANDARD

Shape that duplicates the stock screen.



RACING

Derived of competition their double height diminishes the air effect on helmet.

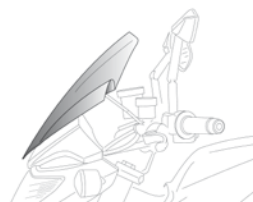

NAKED NEW GENERATION

Designed exclusively for each naked bike model.



TOURING

Its superior height improves protection and rider comfort.



TOURING SCREEN WITH VISOR BOLT-ON

The multi-adjustable visor incorporated allows to vary the effect of air on the pilot.



TOURING SCREEN WITH CLIP-ON VISOR

The multi-adjustable visor clip-on allows to vary the effect of air on the pilot.

MODEL	YEAR	TYPE OF WINDSCREEN	REF.	DIMENSIONS (Height x Width)	HEIGHT (MM) Compared to OEM	N H	W F	R V	T A	G C
VERSYS 650	10' - 14'	TOURING WITH VISOR FIXED BY SCREWS	5905H					(*)		
VERSYS 650	10' - 14'	TOURING WITH VISOR "CLIP ON"	5255 + 6319					(*)		
VERSYS 650	15' - 16'	TOURING	5999	490 x 450	+130			(*)		
VERSYS 650	17' - 18'	TOURING	9421	500 x 450	+130			(*)		
VERSYS 1000	12' - 16'	TOURING	5999	490 x 450	+130			(*)		
VERSYS 1000	17' - 18'	TOURING	9421	500 x 450	+130			(*)		
VULCAN S	15' - 18'	NAKED NEW GENERATION	SEE PAGE 58							
VULCAN S CAFE	17' - 18'	NAKED NEW GENERATION	SEE PAGE 58							
Z250SL	15' - 16'	NAKED NEW GENERATION	SEE PAGE 59							
Z300	15' - 17'	NAKED NEW GENERATION	SEE PAGE 59							
Z650	17' - 18'	NAKED NEW GENERATION	SEE PAGE 59							
Z750S	05' - 06'	RACING	2087	390 x 295				(*)		
Z750	07' - 12'	NAKED NEW GENERATION	SEE PAGE 59							
Z750R	11' - 12'	NAKED NEW GENERATION	SEE PAGE 59							
Z800	13' - 16'	NAKED NEW GENERATION	SEE PAGE 59							
Z800E	13' - 16'	NAKED NEW GENERATION	SEE PAGE 59							
Z900	17' - 18'	NAKED NEW GENERATION	SEE PAGE 59							
Z1000	03' - 06'	STANDARD	1336							(*)
Z1000	03' - 06'	RACING	1520	430 x 270				(*)		(*)
Z1000	07' - 09'	RACING	4361	370 x 295				(*)		(*)
Z1000	10' - 13'	NAKED NEW GENERATION	SEE PAGE 59							
Z1000	14' - 18'	NAKED NEW GENERATION	SEE PAGE 59							
Z1000R	17' - 18'	NAKED NEW GENERATION	SEE PAGE 59							
Z1000SX	11' - 16'	RACING	5606	505 x 400	+53			(*)		(*)
Z1000SX	17' - 18'	RACING	9408	470 X 380				(*)		
ZRX1200R	97' - 06'	TOURING	0426	365 x 325	+117			(*)		(*)
ZRX1200S	01' - 07'	STANDARD	0059							(*)
ZX-6R	01' - 02'	RACING	0514	430 x 385				(*)		(*)
ZX-6R	03' - 04'	RACING	1335	340 x 430						(*)
ZX-6R	05' - 08'	RACING	4053	400 x 360				(*)		(*)
ZX-6R	09' - 16'	STANDARD	5117					(*)		
ZX-6R	09' - 16'	RACING	(Z) 6482	340 x 350	+25			(*)		(*)
ZX-6R 636	13' - 16'	RACING	(Z) 6482	340 x 350	+25			(*)		(*)
ZX-9R	94' - 97'	STANDARD	0344					(*)		
ZX-9R	00' - 04'	RACING	0565	390 x 350						(*)

MODEL	YEAR	TYPE OF WINDSCREEN	REF.	DIMENSIONS (Height x Width)	HEIGHT (MM) Compared to OEM	N H	W F	R V	T A	G C
ZX-10R	04' - 05'	STANDARD	1656	380 x 290				(*)		
ZX-10R	04' - 05'	RACING	1657	380 x 300						(*)
ZX-10R	06' - 07'	STANDARD	4052	360 x 360				(*)		
ZX-10R	06' - 07'	RACING	4053	400 x 360				(*)		(*)
ZX-10R	08' - 10'	STANDARD	5117					(*)		
ZX-10R	08' - 10'	RACING	(Z) 6482	340 x 350	+25			(*)		(*)
ZX-10R	11' - 15'	STANDARD	5602	410 x 390				(*)		
ZX-10R	11' - 15'	RACING	(Z) 5603	410 x 365				(*)		(*)
ZX-10R	16' - 18'	RACING	(Z) 8912	350 x 300	+40			(*)		(*)
ZX-10R	16' - 18'	RACING	(R) 9849	360 x 325	+10			(*)		(*)
ZX-10RR	17' - 18'	RACING	(Z) 8912	350 x 300	+40			(*)		(*)
ZX-10RR	17' - 18'	RACING	(R) 9849	360 x 325	+10			(*)		(*)
ZX-10R SE	18'	RACING	(Z) 8912	350 x 300	+40			(*)		(*)
ZX-10R SE	18'	RACING	(R) 9849	360 x 325	+10			(*)		(*)
ZX-10R KRT REPLICA	18'	RACING	(Z) 8912	350 x 300	+40			(*)		(*)
ZX-10R KRT REPLICA	18'	RACING	(R) 9849	360 x 325	+10			(*)		(*)
ZX-12R	00' - 01'	TOURING	0422	480 x 375	+78			(*)		(*)
ZX-12R	02' - 06'	STANDARD	1121	390 x 380				(*)		(*)
ZZR600	93' - 06'	TOURING	0207	420 x 380	+39			(*)		
ZZR1400	06' - 18'	STANDARD	4056	390 x 375				(*)		
ZZR1400	06' - 18'	RACING	4057	440 x 360	+25			(*)		(*)
KTM										
125 DUKE	11' - 18'	NAKED NEW GENERATION	SEE PAGE 59							
200 DUKE	12 - 15'	NAKED NEW GENERATION	SEE PAGE 59							
390 DUKE	13' - 18'	NAKED NEW GENERATION	SEE PAGE 59							
690 DUKE	08' - 11'	NAKED NEW GENERATION	SEE PAGE 59							
690 DUKE	12' - 18'	NAKED NEW GENERATION	SEE PAGE 59							
690 DUKE R	10' - 11'	NAKED NEW GENERATION	SEE PAGE 59							
690 DUKE R	13' - 17'	NAKED NEW GENERATION	SEE PAGE 59							
950 SUPERMOTO	05' - 07'	NAKED NEW GENERATION	SEE PAGE 59							
950 SUPERMOTO R	07' - 08'	NAKED NEW GENERATION	SEE PAGE 59							
950 SUPERENDURO	06' - 09'	NAKED NEW GENERATION	SEE PAGE 59							
990 SUPERDUKE/R	07' - 13'	NAKED NEW GENERATION	SEE PAGE 59							
990 SUPERMOTO	08' - 13'	NAKED NEW GENERATION	SEE PAGE 59							
990 SUPERMOTO R	09' - 13'	NAKED NEW GENERATION	SEE PAGE 59							
990 SUPERMOTO T	09' - 12'	TOURING	6495	510 x 400	+170			(*)		(*)
1050 ADVENTURE	15' - 16'	RACING	6847	315 X 310	-125			(*)		
1050 ADVENTURE	15' - 16'	TOURING	6494	510 x 420	+50			(*)		(*)
1090 ADVENTURE/R	17' - 18'	RACING	6847	315 X 310	-125			(*)		
1090 ADVENTURE/R	17' - 18'	TOURING	6494	510 x 420	+50			(*)		(*)
1190 ADVENTURE/R	13' - 16'	RACING	6847	315 X 310	-125			(*)		

ANODIZED ALUMINIUM SCREWS AVAILABLE ON PAGE 442

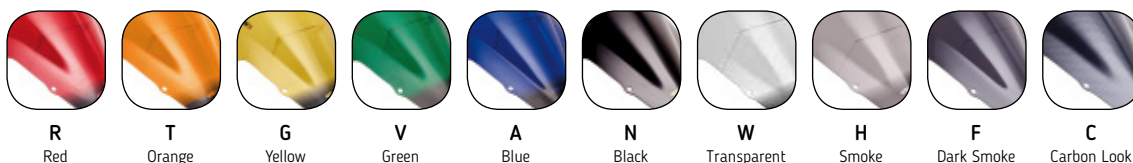

(*) Check price with your distributor.

(-) Adjustable in width and height.

(Z) Z-RACING design. For more information see our website.

(R) R-RACER design. For more information see our website.

CARBON LOOK: Racing screen available only.

NOTE COLORS: F and N colors delivered without silk print.

IMPORTANT: Indicate code color after part#. Example: 0973A.

WINDSCREENS FOR FAIRING BIKES

HI-TECH PARTS | TYPE OF WINDSCREEN:

2019
MODELS:
www.puig.tv



STANDARD

Shape that duplicates the stock screen.



RACING

Derived of competition their double height diminishes the air effect on helmet.



NAKED NEW GENERATION

Designed exclusively for each naked bike model.



TOURING

Its superior height improves protection and rider comfort.



TOURING SCREEN WITH VISOR BOLT-ON

The multi-adjustable visor incorporated allows to vary the effect of air on the pilot.



TOURING SCREEN WITH CLIP-ON VISOR

The multi-adjustable visor clip-on allows to vary the effect of air on the pilot.

MODEL	YEAR	TYPE OF WINDSCREEN	REF.	DIMENSIONS (Height x Width)	HEIGHT (MM) Compared to OEM	N H	W F	R V	T A	G C
1190 ADVENTURE/R	13' - 16'	TOURING	6494	510 x 420	+50	(*)	(*)			
1190 RC8/R	08' - 15'	RACING	(Z) 4944	370 x 350		(*)	(*)			
1290 SUPERDUKE R	14' - 18'	NAKED NEW GENERATION	SEE PAGE 59							
1290 SUPERDUKE GT	16' - 18'	TOURING	8913	600 x 440	+135	(*)	(*)			
1290 SUPERDUKE GT	16' - 18'	TOURING WITH VISOR FIXED BY SCREWS	8914H			(*)				
1290 SUPERDUKE GT	16' - 18'	TOURING WITH VISOR "CLIP ON"	8913 + 6320			(*)				
1290 SUPER ADVENTURE	15' - 16'	RACING	6847	315 X 310	-125	(*)				
1290 SUPER ADVENTURE	15' - 16'	TOURING	6494	510 x 420	+50	(*)	(*)			
1290 SUPER ADVENTURE T	17'	RACING	6847	315 X 310	-125	(*)				
1290 SUPER ADVENTURE T	17'	TOURING	6494	510 x 420	+50	(*)	(*)			
1290 SUPER ADVENTURE R	17' - 18'	RACING	9716	290 X 310	-105	(*)				
1290 SUPER ADVENTURE R	17' - 18'	TOURING	9717	490 X 420	+75	(*)				
1290 SUPER ADVENTURE R	17' - 18'	TOURING WITH VISOR FIXED BY SCREWS	9714			(*)				
1290 SUPER ADVENTURE R	17' - 18'	TOURING WITH VISOR "CLIP ON"	9717 + 6375			(*)				
1290 SUPER ADVENTURE S	17' - 18'	RACING	9716	290 X 310	-105	(*)				
1290 SUPER ADVENTURE S	17' - 18'	TOURING	9717	490 X 420	+75	(*)				
1290 SUPER ADVENTURE S	17' - 18'	TOURING WITH VISOR FIXED BY SCREWS	9714			(*)				
1290 SUPER ADVENTURE S	17' - 18'	TOURING WITH VISOR "CLIP ON"	9717 + 6375			(*)				
RC125/RC390	14' - 18'	RACING	(Z) 7004	410 x 320	+100	(*)	(*)			
MV AGUSTA										
BRUTALE	05' - 09'	NAKED NEW GENERATION	SEE PAGE 60							
BRUTALE 675	12' - 18'	NAKED NEW GENERATION	SEE PAGE 60							
BRUTALE 800/RR	13' - 18'	NAKED NEW GENERATION	SEE PAGE 60							
BRUTALE DRAGSTER 800/RR	14' - 18'	NAKED NEW GENERATION	SEE PAGE 60							
BRUTALE 920	11' - 12'	NAKED NEW GENERATION	SEE PAGE 60							
BRUTALE 1090	13' - 18'	NAKED NEW GENERATION	SEE PAGE 60							
BRUTALE 1090 RR	10' - 18'	NAKED NEW GENERATION	SEE PAGE 60							
F3 675	12' - 18'	RACING	(Z) 5651	330 x 325	+40	(*)	(*)			
F3 800	13' - 18'	RACING	(Z) 5651	330 x 325	+40	(*)	(*)			
F4	10' - 18'	RACING	(Z) 5256	410 x 370		(*)				
F4 1000 RR	13' - 18'	RACING	(Z) 5256	410 x 370		(*)				
RIVALE 800	13' - 18'	NAKED NEW GENERATION	SEE PAGE 60							
STRADALE 800	15' - 16'	TOURING	7634	485 x 365	+120	(*)				
STRADALE 800	15' - 16'	TOURING WITH VISOR FIXED BY SCREWS	7635H			(*)				
STRADALE 800	15' - 16'	TOURING WITH VISOR "CLIP ON"	7634 + 6320			(*)				

MODEL	YEAR	TYPE OF WINDSCREEN	REF.	DIMENSIONS (Height x Width)	HEIGHT (MM) Compared to OEM	N H	W F	R V	T A	G C
TURISMO VELOCE 800/LUSSO	14' - 18'	TOURING	7017	485 x 290	+100	(*)				
TURISMO VELOCE 800/LUSSO	14' - 18'	TOURING WITH VISOR FIXED BY SCREWS	7018H			(*)				
TURISMO VELOCE 800/LUSSO	14' - 18'	TOURING WITH VISOR "CLIP ON"	7017 + 6319			(*)				
RIEJU										
CENTURY 125	18'	NAKED NEW GENERATION	SEE PAGE 60							
SUZUKI										
B-KING	08' - 11'	NAKED NEW GENERATION	SEE PAGE 60							
DL250 V-STROM	17' - 18'	TOURING	9606	440 x 435	+95	(*)				
DL250 V-STROM	17' - 18'	TOURING WITH VISOR FIXED BY SCREWS	9607H			(*)				
DL250 V-STROM	17' - 18'	TOURING WITH VISOR "CLIP ON"	9606 + 6320			(*)				
DL650 V-STROM	04' - 11'	TOURING	1880	515 x 420	+120	(*)		(*)		
DL650 V-STROM	04' - 11'	TOURING WITH VISOR FIXED BY SCREWS	5883H			(*)				
DL650 V-STROM	04' - 11'	TOURING WITH VISOR "CLIP ON"	1880 + 6375			(*)				
DL650 V-STROM	12' - 16'	TOURING	5895	540 x 430	+120	(*)		(*)		
DL650 V-STROM	12' - 16'	TOURING WITH VISOR FIXED BY SCREWS	6253H			(*)				
DL650 V-STROM	12' - 16'	TOURING WITH VISOR "CLIP ON"	5895 + 6320			(*)				
DL650 V-STROM	17' - 18'	TOURING	9719	440 x 445	+120	(*)				
DL650 V-STROM	17' - 18'	TOURING WITH VISOR FIXED BY SCREWS	9440H			(*)				
DL650 V-STROM	17' - 18'	TOURING WITH VISOR "CLIP ON"	9719 + 6320			(*)				
DL650XT V-STROM	15' - 16'	TOURING	5895	540 x 430	+120	(*)		(*)		
DL650XT V-STROM	15' - 16'	TOURING WITH VISOR FIXED BY SCREWS	6253H			(*)				
DL650XT V-STROM	15' - 16'	TOURING WITH VISOR "CLIP ON"	5895 + 6320			(*)				
DL650XT V-STROM	17' - 18'	TOURING	9719			(*)				
DL650XT V-STROM	17' - 18'	TOURING WITH VISOR FIXED BY SCREWS	9440H			(*)				
DL650XT V-STROM	17' - 18'	TOURING WITH VISOR "CLIP ON"	9719 + 6320			(*)				
DL1000 V-STROM	02' - 07'	TOURING	1880	515 x 420	+120	(*)		(*)		
DL1000 V-STROM	14' - 18'	TOURING	7229	460 x 435	+165	(*)				
DL1000 V-STROM	14' - 18'	TOURING WITH VISOR FIXED BY SCREWS	7230H			(*)				
DL1000 V-STROM	14' - 18'	TOURING WITH VISOR "CLIP ON"	7229 + 6320			(*)				
DL1000XT V-STROM	17' - 18'	TOURING	7229	460 x 435	+165	(*)				
DL1000XT V-STROM	17' - 18'	TOURING WITH VISOR FIXED BY SCREWS	7230H			(*)				
DL1000XT V-STROM	17' - 18'	TOURING WITH VISOR "CLIP ON"	7229 + 6320			(*)				
GS500F	04' - 07'	RACING	1652	340 x 370		(*)				
GSF600S BANDIT	00' - 04'	STANDARD	0697			(*)		(*)		
GSF600S BANDIT	00' - 04'	RACING	1116	375 x 375		(*)				
GSF650 BANDIT	09' - 11'	NAKED NEW GENERATION	SEE PAGE 60							
GSF650S BANDIT	05' - 08'	STANDARD	2098			(*)				
GSF650S BANDIT	05' - 08'	RACING	2107	340 x 360		(*)				
GSF650S BANDIT	05' - 08'	TOURING	2125	410 x 360	+80	(*)		(*)		
GSF1200S BANDIT	01' - 05'	STANDARD	0697			(*)		(*)		
GSF1200S BANDIT	01' - 05'	RACING	1116	375 x 375		(*)				

ANODIZED ALUMINIUM SCREWS AVAILABLE ON PAGE 442

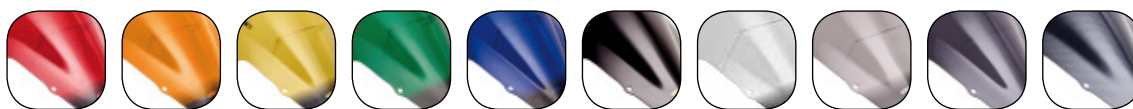

R Red T Orange G Yellow V Green A Blue N Black W Transparent H Smoke F Dark Smoke C Carbon Look

(*) Check price with your distributor.

(-) Adjustable in width and height.

(Z) Z-RACING design. For more information see our website.

(R) R-RACER design. For more information see our website.

CARBON LOOK: Racing screen available only.

NOTE COLORS: F and N colors delivered without silk print.

IMPORTANT: Indicate code color after part#. Example: 0973A.

WINDSCREENS FOR FAIRING BIKES

HI-TECH PARTS | TYPE OF WINDSCREEN:

2019
MODELS:
www.puig.tv

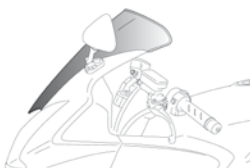

STANDARD

Shape that duplicates the stock screen.



RACING

Derived of competition their double height diminishes the air effect on helmet.



NAKED NEW GENERATION

Designed exclusively for each naked bike model.



TOURING

Its superior height improves protection and rider comfort.



TOURING SCREEN WITH VISOR BOLT-ON

The multi-adjustable visor incorporated allows to vary the effect of air on the pilot.



TOURING SCREEN WITH CLIP-ON VISOR

The multi-adjustable visor clip-on allows to vary the effect of air on the pilot.

MODEL	YEAR	TYPE OF WINDSCREEN	REF.	DIMENSIONS (Height x Width)	HEIGHT (MM) Compared to OEM	N H	W F	R V	T A	G C
GSF1200S BANDIT	06'	STANDARD	2098			(*)				
GSF1200S BANDIT	06'	RACING	2107	340 x 360		(*)				
GSF1200S BANDIT	06'	TOURING	2125	410 x 355	+80	(*)		(*)		
GSF1250 BANDIT	10' - 13'	NAKED NEW GENERATION	SEE PAGE 60							
GSF1250S BANDIT	07' - 16'	STANDARD	2098			(*)				
GSF1250S BANDIT	07' - 16'	RACING	2107	340 x 360		(*)				
GSF1250S BANDIT	07' - 16'	TOURING	2125	410 x 355	+80	(*)		(*)		
GSR600	06' - 11'	NAKED NEW GENERATION	SEE PAGE 60							
GSR750	11' - 16'	NAKED NEW GENERATION	SEE PAGE 60							
GSX650F	08' - 16'	STANDARD	4632	340 x 390		(*)				
GSX650F	08' - 16'	RACING	4665	340 x 400		(*)		(*)		
GSX650F	08' - 16'	TOURING	4633	450 x 395	+110	(*)		(*)		
GSX1250F	10' - 17'	STANDARD	4632	340 x 390		(*)				
GSX1250F	10' - 17'	RACING	4665	340 x 400		(*)		(*)		
GSX1250F	10' - 17'	TOURING	4633	450 x 395	+110	(*)		(*)		
GSX-R125	17' - 18'	RACING	9721	340 x 305	+10	(*)		(*)		
GSX-R250	17' - 18'	RACING	9722	365 x 300	+45	(*)		(*)		
GSX-R600	98' - 00'	RACING	0950	430 x 395		(*)		(*)		
GSX-R600	98' - 00'	TOURING	0798	450 x 415	+50	(*)		(*)		
GSX-R600	01' - 03'	STANDARD	0053	400 x 420		(*)				
GSX-R600	01' - 03'	RACING	0189	400 x 430		(*)		(*)		
GSX-R750	98' - 99'	RACING	0950	430 x 395		(*)		(*)		
GSX-R750	98' - 99'	TOURING	0798	450 x 415	+50	(*)		(*)		
GSX-R750	00' - 03'	STANDARD	0053	400 x 420		(*)				
GSX-R750	00' - 03'	RACING	0189	400 x 430		(*)				
GSX-R600/750	04' - 05'	STANDARD	1654	350 x 330						(*)
GSX-R600/750	04' - 05'	RACING	1655	350 x 340		(*)		(*)		(*)
GSX-R600/750	06' - 07'	RACING	4055	355 x 320		(*)		(*)		(*)
GSX-R600/750	08' - 10'	STANDARD	4628			(*)				
GSX-R600/750	08' - 10'	RACING	(Z) 4629	350 x 325		(*)		(*)		(*)
GSX-R600/750	11' - 16'	RACING	(Z) 5605	280 x 300		(*)		(*)		(*)
GSX-R1000	01' - 02'	STANDARD	0053	400 x 420		(*)				
GSX-R1000	01' - 02'	RACING	0189	400 x 430		(*)		(*)		(*)
GSX-R1000	03' - 04'	STANDARD	1338			(*)		(*)		(*)
GSX-R1000	03' - 04'	RACING	1340	400 x 470		(*)		(*)		(*)

MODEL	YEAR	TYPE OF WINDSCREEN	REF.	DIMENSIONS (Height x Width)	HEIGHT (MM) Compared to OEM	N H	W F	R V	T A	G C
GSX-R1000	05' - 06'	STANDARD	2071	320 x 320		(*)				(*)
GSX-R1000	05' - 06'	RACING	2072	310 x 300		(*)				(*)
GSX-R1000	07' - 08'	STANDARD	4362			(*)				(*)
GSX-R1000	07' - 08'	RACING	4363	320 x 330		(*)				(*)
GSX-R1000	09' - 15'	STANDARD	4932	370 x 330		(*)				
GSX-R1000	09' - 16'	RACING	(Z) 4933	360 x 340		(*)				(*)
GSX-R1000/R	17' - 18'	RACING	(Z) 9013	310 x 275		(*)				(*)
GSX-R1300 HAYABUSA	99' - 07'	RACING	0953	370 x 450		(*)				(*)
GSX-R1300 HAYABUSA	08' - 17'	STANDARD	4825	400 x 440		(*)				
GSX-R1300 HAYABUSA	08' - 17'	RACING	4826	390 x 440		(*)				(*)
GSX-S125	17' - 18'	NAKED NEW GENERATION	SEE PAGE 60							
GSX-S750	17' - 18'	NAKED NEW GENERATION	SEE PAGE 60							
GSX-S1000	15' - 18'	NAKED NEW GENERATION	SEE PAGE 60							
GSX-S1000F	15' - 18'	RACING	7639	330 x 280	-160	(*)				(*)
GSX-S1000F	15' - 18'	TOURING	7640	590 x 325	+135	(*)				
GSX-S1000F	15' - 18'	TOURING WITH VISOR FIXED BY SCREWS	7641H			(*)				
GSX-S1000F	15' - 18'	TOURING WITH VISOR "CLIP ON"	7640 + 6320			(*)				
INAZUMA	13' - 17'	NAKED NEW GENERATION	SEE PAGE 60							
INAZUMA F	15' - 17'	RACING	(Z) 7642	410 x 390	+75	(*)				
RF600	93' - 99'	TOURING	0640	460 x 400	+115					(*)
RF900R	93' - 99'	TOURING	0640	460 x 400	+115					(*)
SFV650 GLADIUS	09' - 15'	NAKED NEW GENERATION	SEE PAGE 60							
SV650S	03' - 08'	STANDARD	1344	350 x 375						(*)
SV650S	03' - 08'	RACING	1346	350 x 370		(*)				(*)
SV1000S	03' - 05'	STANDARD	1344	350 x 375						(*)
SV1000S	03' - 05'	RACING	1346	350 x 370		(*)				(*)
TL1000R	98' - 99'	STANDARD	0459			(*)				
TRIUMPH										
BONNEVILLE BOBBER	17' - 18'	NAKED NEW GENERATION								
BONNEVILLE SPEEDMASTER	18'	NAKED NEW GENERATION								
DAYTONA 600	03' - 04'	RACING	1928	410 x 370		(*)				(*)
DAYTONA 650	05'	RACING	1928	410 x 370		(*)				(*)
DAYTONA 675	06' - 08'	RACING	4108	415 x 350		(*)				(*)
DAYTONA 675	09' - 12'	RACING	(Z) 4939	440 x 300		(*)				(*)
DAYTONA 675	13' - 17'	RACING	(Z) 6498	390 x 300	+30	(*)				(*)
DAYTONA 675 R	11' - 12'	RACING	(Z) 4939	440 x 300		(*)				(*)
DAYTONA 675 R	13' - 17'	RACING	(Z) 6498	390 x 300	+30	(*)				(*)
DAYTONA 955i	01' - 03'	RACING	1927	280 x 410						(*)
SPEED TRIPLE	05' - 18'	NAKED NEW GENERATION	SEE PAGE 60							
SPEED TRIPLE R	12' - 18'	NAKED NEW GENERATION	SEE PAGE 61							
STREET TRIPLE	07' - 18'	NAKED NEW GENERATION	SEE PAGE 61							

ANODIZED ALUMINIUM SCREWS AVAILABLE ON PAGE 442

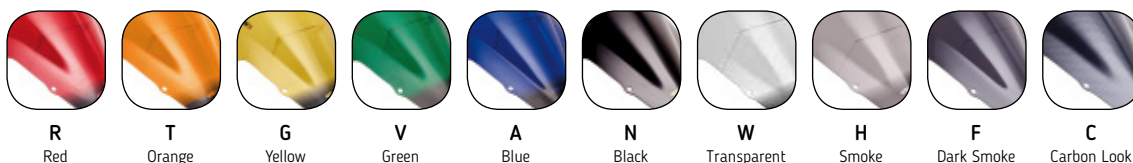

(*) Check price with your distributor.

(-) Adjustable in width and height.

(Z) Z-RACING design. For more information see our website.

(R) R-RACER design. For more information see our website.

CARBON LOOK: Racing screen available only.

NOTE COLORS: F and N colors delivered without silk print.

IMPORTANT: Indicate code color after part#. Example: 0973A.

WINDSCREENS FOR FAIRING BIKES

HI-TECH PARTS | TYPE OF WINDSCREEN:

2019
MODELS:
www.puig.tv

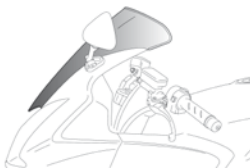

STANDARD

Shape that duplicates the stock screen.



RACING

Derived of competition their double height diminishes the air effect on helmet.



NAKED NEW GENERATION

Designed exclusively for each naked bike model.



TOURING

Its superior height improves protection and rider comfort.



TOURING SCREEN WITH VISOR BOLT-ON

The multi-adjustable visor incorporated allows to vary the effect of air on the pilot.



TOURING SCREEN WITH CLIP-ON VISOR

The multi-adjustable visor clip-on allows to vary the effect of air on the pilot.

MODEL	YEAR	TYPE OF WINDSCREEN	REF.	DIMENSIONS (Height x Width)	HEIGHT (MM) Compared to OEM	N H	W F	R V	T A	G C
STREET TRIPLE R	08' - 18'	NAKED NEW GENERATION	SEE PAGE 61							
STREET TRIPLE S	17' - 18'	NAKED NEW GENERATION	SEE PAGE 61							
STREET TRIPLE RS	17' - 18'	NAKED NEW GENERATION	SEE PAGE 61							
STREET TRIPLE S	17' - 18'	NAKED NEW GENERATION	SEE PAGE 61							
TIGER 800/ XC	11' - 14'	TOURING	5652 (-)	490 x 430	+130					
TIGER 800/XC	11' - 14'	TOURING WITH VISOR FIXED BY SCREWS	5918H							
TIGER 800/XC	11' - 14'	TOURING WITH VISOR "CLIP ON"	5652 + 6320							
TIGER 800 XC/XCX/XCA	15' - 17'	TOURING	5652 (-)	490 x 430	+130					
TIGER 800 XC/XCX/XCA	15' - 17'	TOURING WITH VISOR FIXED BY SCREWS	5918H							
TIGER 800 XC/XCX/XCA	15' - 17'	TOURING WITH VISOR "CLIP ON"	5652 + 6320							
TIGER 800 XR/XRX/XRT	15' - 17'	TOURING	5652 (-)	490 x 430	+130					
TIGER 800 XR/XRX/XRT	15' - 17'	TOURING WITH VISOR FIXED BY SCREWS	5918H							
TIGER 800 XR/XRX/XRT	15' - 17'	TOURING WITH VISOR "CLIP ON"	5652 + 6320							
TIGER 800 XC/XCX/XCA/XR/XRX/XRT	18'	TOURING	9656	550 x 440	+115					
TIGER 800 XC/XCX/XCA/XR/XRX/XRT	18'	TOURING WITH VISOR FIXED BY SCREWS	9658							
TIGER 800 XC/XCX/XCA/XR/XRX/XRT	18'	TOURING WITH VISOR "CLIP ON"	9656 + 6375							
TIGER 1050	07' - 13'	TOURING	4359	470 x 350	+75					
TIGER 1050	07' - 13'	TOURING WITH VISOR FIXED BY SCREWS	5919H							
TIGER 1050	07' - 13'	TOURING WITH VISOR "CLIP ON"	4359 + 6320							
TIGER EXPLORER	12' - 15'	TOURING	6000	560 x 510	+100					
TIGER EXPLORER	12' - 15'	TOURING WITH VISOR FIXED BY SCREWS	6006H							
TIGER EXPLORER	12' - 15'	TOURING WITH VISOR "CLIP ON"	6000 + 6319							
TIGER EXPLORER XC	13' - 15'	TOURING	6000	560 x 510	+100					
TIGER EXPLORER XC	13' - 15'	TOURING WITH VISOR FIXED BY SCREWS	6006H							
TIGER EXPLORER XC	13' - 15'	TOURING WITH VISOR "CLIP ON"	6000 + 6319							
TIGER EXPLORER XC/XR/XRX/XRT/XCX/XCA	16' - 17'	TOURING	8915	630 x 410	+90					
TIGER EXPLORER XC/XR/XRX/XRT/XCX/XCA	16' - 17'	TOURING WITH VISOR FIXED BY SCREWS	8916							
TIGER EXPLORER XC/XR/XRX/XRT/XCX/XCA	16' - 17'	TOURING WITH VISOR "CLIP ON"	8915 + 6375							
TIGER EXPLORER XC/XR/XRX/XRT/XCX/XCA	18'	TOURING	9613	620 x 495	+80					
TIGER EXPLORER XC/XR/XRX/XRT/XCX/XCA	18'	TOURING WITH VISOR FIXED BY SCREWS	9614H							
TIGER EXPLORER XC/XR/XRX/XRT/XCX/XCA	18'	TOURING WITH VISOR "CLIP ON"	9613 + 6320							
TIGER SPORT	13' - 15'	TOURING	4359	500 x 355	+75					
TIGER SPORT	13' - 15'	TOURING WITH VISOR FIXED BY SCREWS	5919H							
TIGER SPORT	13' - 15'	TOURING WITH VISOR "CLIP ON"	4359 + 6320							
TIGER SPORT	16' - 18'	TOURING	9200	615 x 440	+120					

MODEL	YEAR	TYPE OF WINDSCREEN	REF.	DIMENSIONS (Height x Width)	HEIGHT (MM) Compared to OEM	N H	W F	R V	T A	G C
TIGER SPORT	16' - 18'	TOURING WITH VISOR FIXED BY SCREWS	9201H							
TIGER SPORT	16' - 18'	TOURING WITH VISOR "CLIP ON"	9200 + 6320							
YAMAHA										
FAZER8	13' - 16'	RACING	(Z) 5572	430 x 330	+105					
FJR1300	01' - 05'	TOURING	1281	540 x 520	+130					
FJR1300A/AS	06' - 12'	TOURING	4103	500 x 505	+35					
FJR1300A/AS	13' - 18'	TOURING	6483	560 x 570	+120					
FJR1300A/AS	13' - 18'	TOURING WITH VISOR FIXED BY SCREWS	6501H							
FJR1300A/AS	13' - 18'	TOURING WITH VISOR "CLIP ON"	6483 + 6375							
FZ1	06' - 15'	NAKED NEW GENERATION	SEE PAGE 61							
FZ1 FAZER	06' - 15'	RACING	4061	410 x 300						
FZ1 FAZER	06' - 15'	TOURING	4101	480 x 420	+100					
FZ1 FAZER	06' - 15'	TOURING WITH VISOR FIXED BY SCREWS	5907H							
FZ1 FAZER	06' - 15'	TOURING WITH VISOR "CLIP ON"	4101 + 6320							
FZ6	04' - 08'	NAKED NEW GENERATION	SEE PAGE 61							
FZ6 S2	07' - 10'	NAKED NEW GENERATION	SEE PAGE 61							
FZ6 FAZER	04' - 08'	RACING	1646	550 x 570						
FZ6 FAZER	04' - 08'	TOURING	1647	590 x 540	+90					
FZ6 FAZER S2	07' - 10'	RACING	4366	420 x 330						
FZ6 FAZER S2	07' - 10'	TOURING	4367	475 x 335	+100					
FZ6 FAZER S2	07' - 10'	TOURING WITH VISOR FIXED BY SCREWS	5908H							
FZ6 FAZER S2	07' - 10'	TOURING WITH VISOR "CLIP ON"	4367 + 6320							
FZ750	87' - 95'	TOURING	0595	410 x 310	+71					
FZ8	10' - 16'	NAKED NEW GENERATION	SEE PAGE 61							
FZ8 FAZER	10' - 12'	RACING	(Z) 5572	430 x 330	+105					
FZS600 FAZER	02' - 03'	TOURING	1111	455 x 330	+90					
FZS1000 FAZER	01' - 05'	RACING	1053	340 x 320						
MT-125	14' - 18'	NAKED NEW GENERATION	SEE PAGE 61							
MT-03	16' - 18'	NAKED NEW GENERATION	SEE PAGE 61							
MT-07	14' - 18'	NAKED NEW GENERATION	SEE PAGE 61							
MT-07 TRACER	16' - 18'	RACING	(Z) 9211	406 x 290	-50					
MT-07 TRACER	16' - 18'	TOURING	9212	600 X 360	+150					
MT-07 TRACER	16' - 18'	TOURING WITH VISOR FIXED BY SCREWS	9213							
MT-07 TRACER	16' - 18'	TOURING WITH VISOR "CLIP ON"	9212 + 6375							
MT-09	13' - 18'	NAKED NEW GENERATION	SEE PAGE 61							
MT-09 TRACER	15' - 17'	RACING	7645	390 x 290	-60					
MT-09 TRACER	15' - 17'	TOURING	7646	640 x 405	+160					
MT-09 TRACER	18'	RACING	9724	376 x 287	-140					
MT-09 TRACER	18'	TOURING	9725	645 x 445	+105					
MT-09 TRACER	18'	TOURING WITH VISOR FIXED BY SCREWS	9726							
MT-09 TRACER	18'	TOURING WITH VISOR "CLIP ON"	9725 + 6375							

ANODIZED ALUMINIUM SCREWS AVAILABLE ON PAGE 442

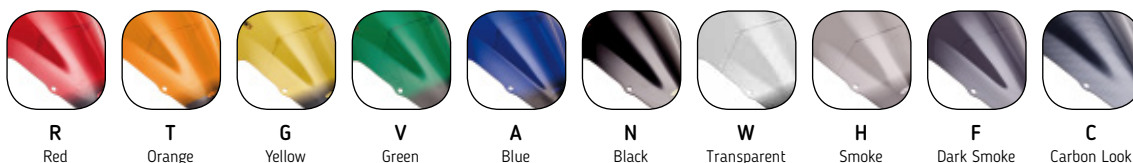

(*) Check price with your distributor.

(-) Adjustable in width and height.

(Z) Z-RACING design. For more information see our website.

(R) R-RACER design. For more information see our website.

CARBON LOOK: Racing screen available only.

NOTE COLORS: F and N colors delivered without silk print.

IMPORTANT: Indicate code color after part#. Example: 0973A.

WINDSCREENS FOR FAIRING BIKES

HI-TECH PARTS | TYPE OF WINDSCREEN:

2019
MODELS:
www.puig.tv

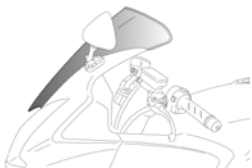

STANDARD

Shape that duplicates the stock screen.



RACING

Derived of competition their double height diminishes the air effect on helmet.



NAKED NEW GENERATION

Designed exclusively for each naked bike model.



TOURING

Its superior height improves protection and rider comfort.



TOURING SCREEN WITH VISOR BOLT-ON

The multi-adjustable visor incorporated allows to vary the effect of air on the pilot.



TOURING SCREEN WITH CLIP-ON VISOR

The multi-adjustable visor clip-on allows to vary the effect of air on the pilot.

MODEL	YEAR	TYPE OF WINDSCREEN	REF.	DIMENSIONS (Height x Width)	HEIGHT (MM) Compared to OEM	N H	W F	R V	T A	G C
MT-09 TRACER GT	18'	RACING	9724	376 x 287	-140	(*)				
MT-09 TRACER GT	18'	TOURING	9725	645 x 445	+105	(*)				
MT-09 TRACER GT	18'	TOURING WITH VISOR FIXED BY SCREWS	9726			(*)				
MT-09 TRACER GT	18'	TOURING WITH VISOR "CLIP ON"	9725 + 6375			(*)				
MT-10	16' - 18'	RACING	8917	360 x 320	+475	(*)			(*)	
MT-10	16' - 18'	TOURING	8918	500 X 350	+225	(*)				
MT-10	16' - 18'	TOURING WITH VISOR FIXED BY SCREWS	8919			(*)				
MT-10	16' - 18'	TOURING WITH VISOR "CLIP ON"	8918 + 6320			(*)				
MT-10 SP	17' - 18'	RACING	8917	360 x 320		(*)			(*)	
MT-10 SP	17' - 18'	TOURING	8918	500 X 350	+225	(*)				
MT-10 SP	17' - 18'	TOURING WITH VISOR FIXED BY SCREWS	8919			(*)				
MT-10 SP	17' - 18'	TOURING WITH VISOR "CLIP ON"	8918 + 6320			(*)				
TDM 900	02' - 13'	STANDARD	1106			(*)				
TZR50	03' - 16'	STANDARD	1596	365 x 300						(*)
VMAX	09' - 16'	NAKED NEW GENERATION	SEE PAGE 61							
XJ6	09' - 16'	NAKED NEW GENERATION	SEE PAGE 61							
XJ6 DIVERSION	09' - 16'	TOURING	4938	505 x 415	+150	(*)				
XJ6 DIVERSION	09' - 16'	TOURING WITH VISOR FIXED BY SCREWS	5909H			(*)				
XJ6 DIVERSION	09' - 16'	TOURING WITH VISOR "CLIP ON"	4938 + 6375			(*)				
XJ6 DIVERSION F	10' - 16'	RACING	5547	390 x 260		(*)			(*)	
XJ6 DIVERSION F	10' - 16'	TOURING	5548	500 x 360	+130	(*)				
XJ6 DIVERSION F	10' - 16'	TOURING WITH VISOR FIXED BY SCREWS	5910H			(*)				
XJ6 DIVERSION F	10' - 16'	TOURING WITH VISOR "CLIP ON"	5548 + 6320			(*)				
XT660X	07' - 16'	NAKED NEW GENERATION	SEE PAGE 61							
XT660Z TÉNÉRÉ	08' - 16'	TOURING	4636	385 x 470	+80	(*)			(*)	
XT660Z TÉNÉRÉ	08' - 16'	TOURING WITH VISOR FIXED BY SCREWS	5912H			(*)				
XT660Z TÉNÉRÉ	08' - 16'	TOURING WITH VISOR "CLIP ON"	4636 + 6319			(*)				
XT1200Z SUPER TÉNÉRÉ	10' - 13'	TOURING	5568	505 x 450	+80	(*)				
XT1200Z SUPER TÉNÉRÉ	10' - 13'	TOURING WITH VISOR FIXED BY SCREWS	5911H			(*)				
XT1200Z SUPER TÉNÉRÉ	10' - 13'	TOURING WITH VISOR "CLIP ON"	5568 + 6375			(*)				
XT1200Z SUPER TÉNÉRÉ	14' - 18'	TOURING	7541	600 x 465	+140	(*)				
XT1200Z SUPER TÉNÉRÉ	14' - 18'	TOURING WITH VISOR FIXED BY SCREWS	7600H			(*)				
XT1200Z SUPER TÉNÉRÉ	14' - 18'	TOURING WITH VISOR "CLIP ON"	7541 + 6320			(*)				
XV950/R	14' - 18'	NAKED NEW GENERATION	SEE PAGE 61							
XV950 RACER	16' - 18'	NAKED NEW GENERATION	SEE PAGE 61							

MODEL	YEAR	TYPE OF WINDSCREEN	REF.	DIMENSIONS (Height x Width)	HEIGHT (MM) Compared to OEM	N H	W F	R V	T A	G C
YZF 600 R THUNDERCAT	96' - 02'	STANDARD	0594							
YZF 600 R THUNDERCAT	96' - 02'	RACING	1124	330 x 390						(*)
YZF 1000 R THUNDERACE	96' - 03'	RACING	0287	420 x 445	+57					(*)
YZF-R125	08' - 18'	RACING	4637	370 x 255	+45					(*)
YZF-R1	02' - 03'	RACING	1145	415 x 300						(*)
YZF-R1	04' - 05'	STANDARD	1649							(*)
YZF-R1	04' - 06'	RACING	1650	480 x 330						(*)
YZF-R1 SP	06'	STANDARD	1649							(*)
YZF-R1	07' - 08'	STANDARD	4364	450 x 380						(*)
YZF-R1	07' - 08'	RACING	4365	420 x 350						(*)
YZF-R1	09' - 14'	STANDARD	4934	440 x 380						(*)
YZF-R1	09' - 14'	RACING	(Z) 4935	450 x 360						(*)
YZF-R1	15' - 18'	RACING	(Z) 7648	335 x 290	+30					(*)
YZF-R1M	17' - 18'	RACING	(Z) 7648	335 x 290	+30					(*)
YZF-R3	15' - 18'	RACING	(Z) 7649	300 x 295	+30					(*)
YZF-R6	99' - 02'	RACING	0021	310 x 360						(*)
YZF-R6	99' - 02'	TOURING	0626	360 x 350	+3					(*)
YZF-R6	03' - 05'	RACING	1328	450 x 380						(*)
YZF-R6	06' - 07'	STANDARD	4058	345 x 345						(*)
YZF-R6	06' - 07'	RACING	4059	320 x 370						(*)
YZF-R6	08' - 16'	STANDARD	4634							(*)
YZF-R6	08' - 16'	RACING	(Z) 4635	350 x 370						(*)
YZF-R6	17' - 18'	RACING	(Z) 9723	360 x 285	+30					(*)

ANODIZED ALUMINIUM SCREWS AVAILABLE ON PAGE 442

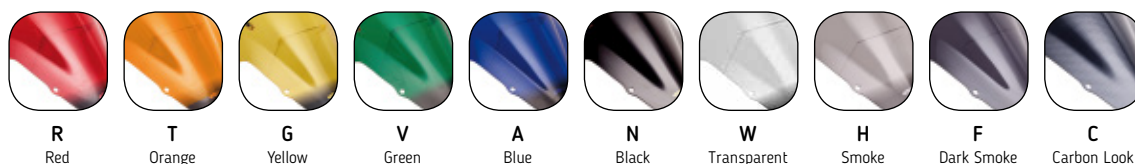

(*) Check price with your distributor.

(-) Adjustable in width and height.

(Z) Z-RACING design. For more information see our website.

(R) R-RACER design. For more information see our website.

CARBON LOOK: Racing screen available only.

NOTE COLORS: F and N colors delivered without silk print.

IMPORTANT: Indicate code color after part#. Example: 0973A.



// E.R.S.
(Electronic Regulable System)

Electronic mechanism, of easy mounting process, allows the windscreen to move up and down by actuating a switch even while driving. The range is 150 mm. to adjust at rider's taste, according to height and climate. Improves rider's comfort. It can be mounted with a Puig or OEM screen.



LOWEST POSITION



HIGHEST POSITION



AUTOMATIC



PLUG & PLAY



MECHANISM

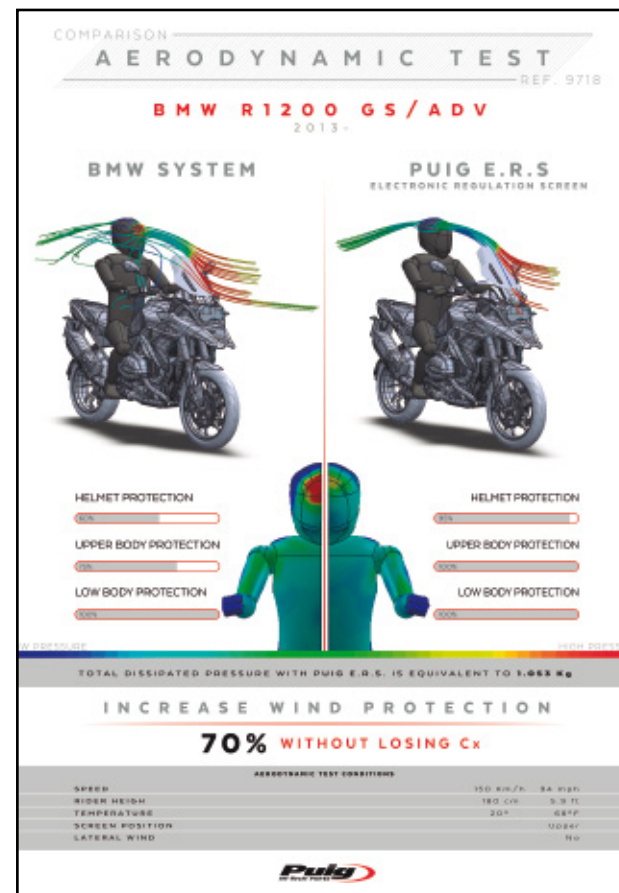

Aerodynamic tests supplied along with most of our windscreens.

MODEL	YEAR	REF.	PRICE
BMW			
R1200GS	13' - 18'	9718N	(*)
R1200GS ADVENTURE	14' - 18'	9718N	(*)
R1200GS EXCLUSIVE	17' - 18'	9718N	(*)
R1200GS RALLYE	17' - 18'	9718N	(*)
R1250GS	18'	9718N	(*)
R1250GS ADVENTURE	18'	9718N	(*)
YAMAHA			
MT-09 TRACER	15' - 17'	0067N	(*)



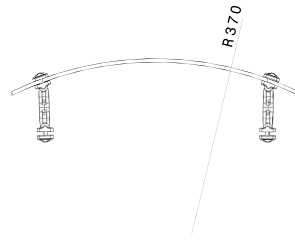
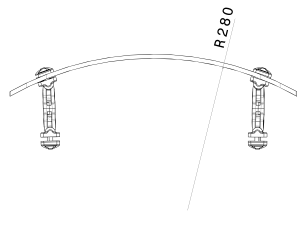
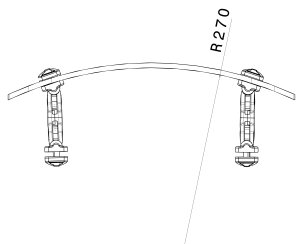
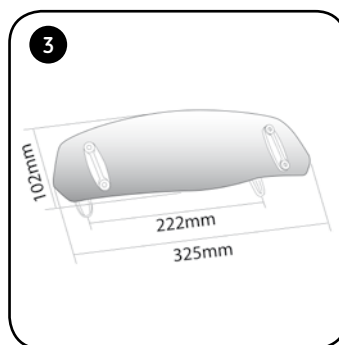
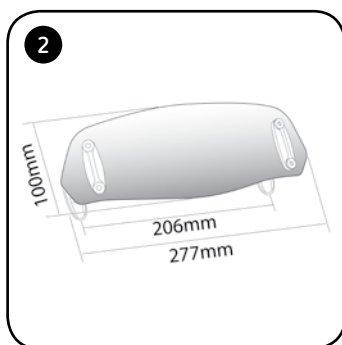
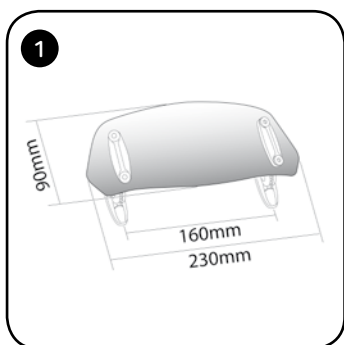

REFERENCE	W	H
6007	(*)	

REFERENCE	W	H
5852	(*)	

REFERENCE	W	H
5853	(*)	

The multi-adjustable bolt-on visors can be mounted on the Puig windscreen as well as on the stock one. Check compatibility and references in our website.

// MOUNTING PROCEDURE

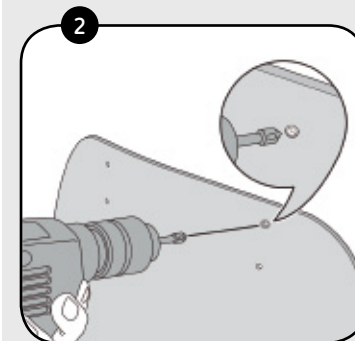
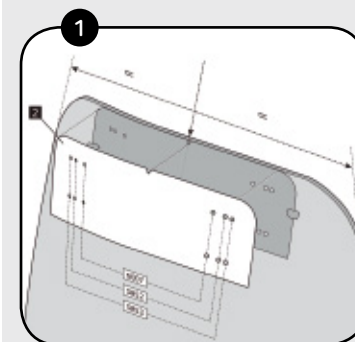

* Template delivered.

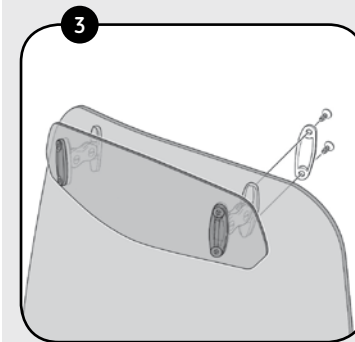

NOTE:
If order "touring with visor" kit, the windscreen will come factory-drilled so no drilling is necessary.

SPARES	REFERENCE	W	H	N
MULTI-ADJUSTABLE MECHANISM BY PAIR	6271			(*)
VISOR SPARE N.1 (230 x 90 mm.)	6268	(*)		
VISOR SPARE N.2 (277 x 100 mm.)	6269	(*)		
VISOR SPARE N.3 (325 x 102 mm.)	6270	(*)		



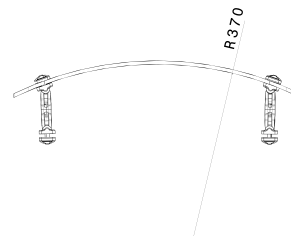
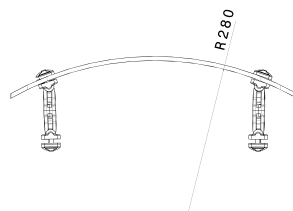
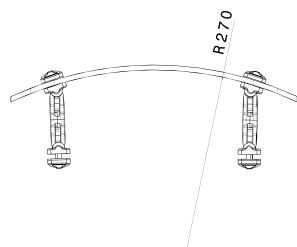
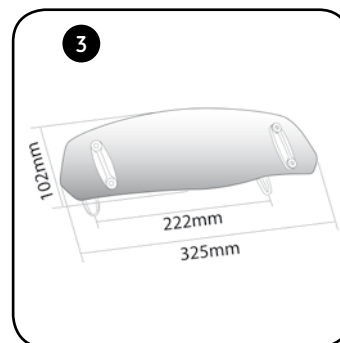
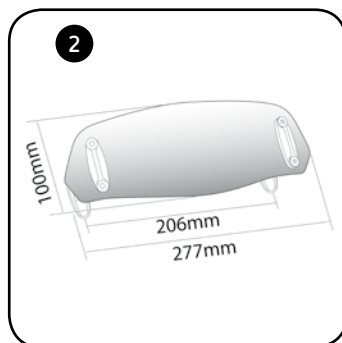
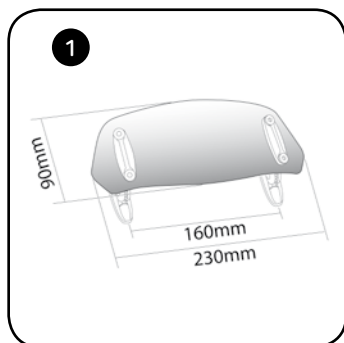

REFERENCE	W	H
6319	(*)	(*)

REFERENCE	W	H
6320	(*)	(*)

REFERENCE	W	H
6375	(*)	(*)

The multi-adjustable clip-on visors can be mounted on the Puig windshield as well as on the stock one.
 Check compatibility and references [in our website](#).

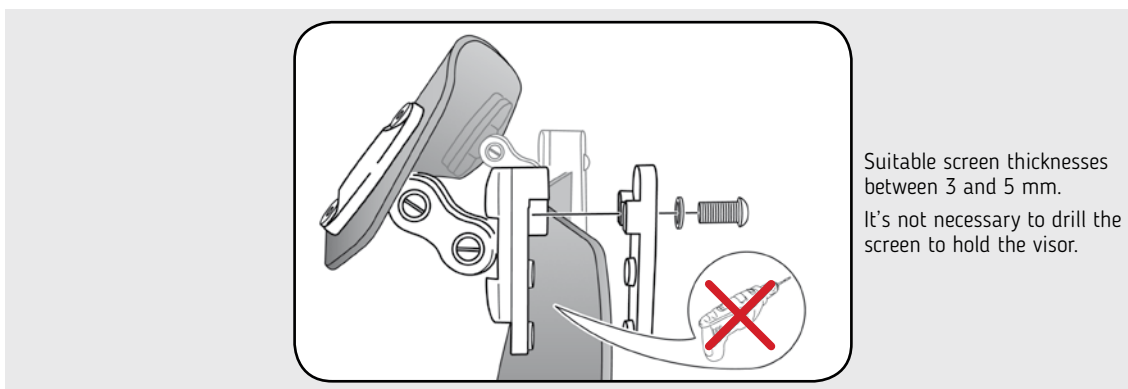

SPARES	REFERENCE	W	H	N
MULTI-ADJUSTABLE MECHANISM BY PAIR	6799			(*)
VISOR SPARE N.1 (230X90 mm.)	6871	(*)		
VISOR SPARE N.2 (277X100 mm.)	6872	(*)		
VISOR SPARE N.3 (325X102 mm.)	6873	(*)		



pulg

G 650
by pulg

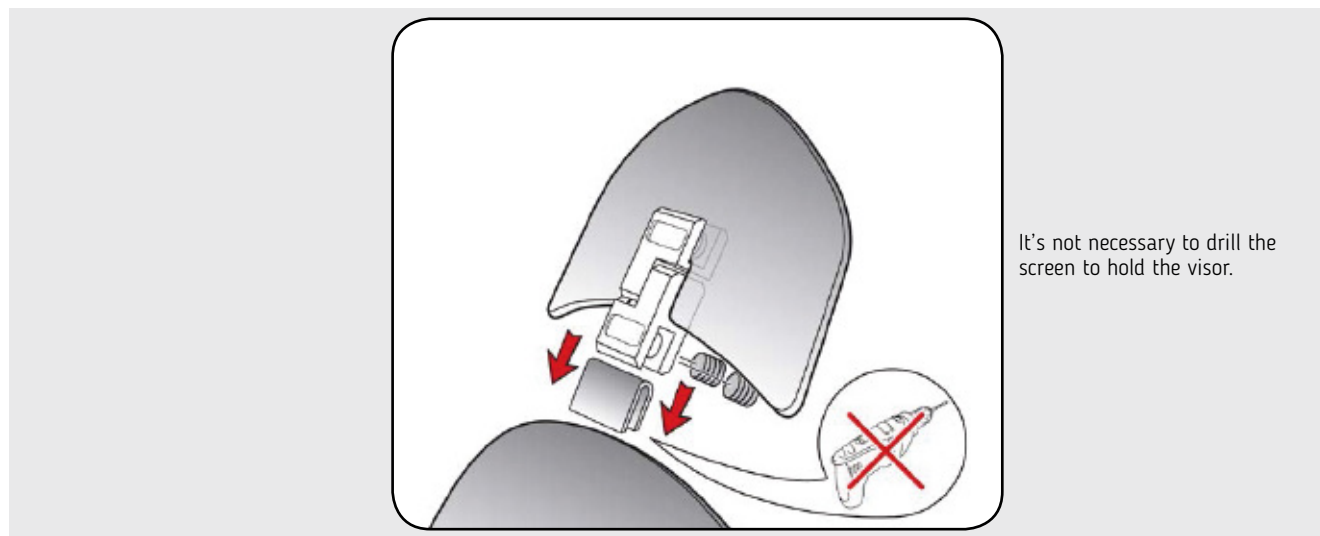

It's not necessary to drill the screen to hold the visor.

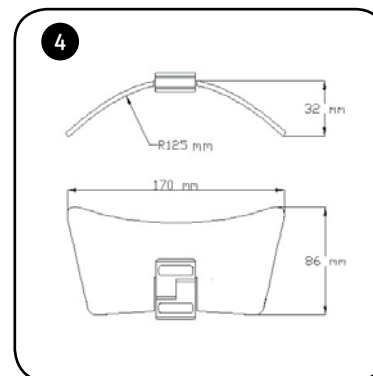
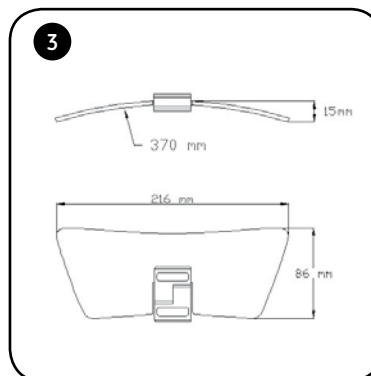
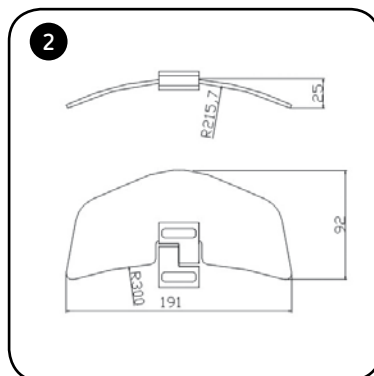
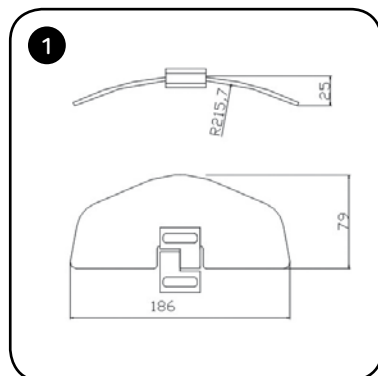

MODEL	REFERENCE	W	H	D
DEFLECTOR 1	4639	(*)	(*)	
DEFLECTOR 2	4717	(*)	(*)	
DEFLECTOR 3	4835	(*)		
DEFLECTOR 4	4837	(*)		
METALLIC MECHANISM	6878D			(*)

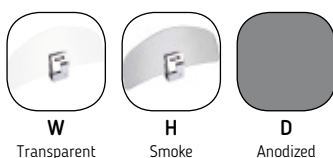

W
Transparent

H
Smoke

D
Anodized

(*) Check price with your distributor.

IMPORTANT: Indicate code color after part#. Example: 0973A.





// VIRTUAL WIND TUNNEL TESTED



● Lower pressure
● Max. pressure
Wind pressure without
Windshield Naked New
Generation Puig.



● Lower pressure
● Max. pressure
Wind pressure with
Windshield Naked New
Generation Puig.



Improve aerodynamics
and windprotection on
average +12.7%.

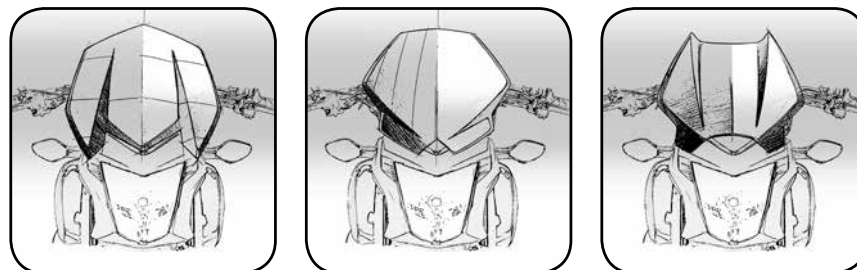

A specific design for each bike.



The shape of the windshield may vary according to the motorcycle model.
Please visit our website.

WINDSHIELDS SPECIFIC FOR NON-ROUND HEADLIGHTS

HI-TECH PARTS | TYPE OF WINDSHIELD:

2019
MODELS:
www.puig.tv

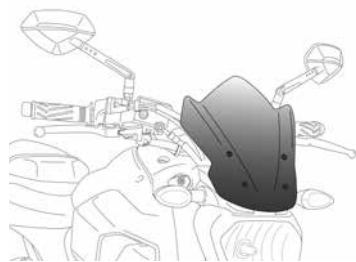

SPORT

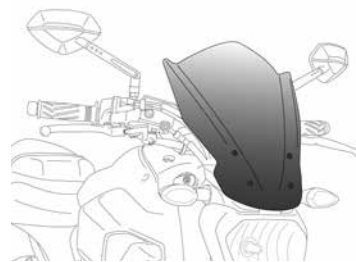

TOURING



SUPPORT M.E.M.

MODEL	YEAR	TYPE	REF.	DIMENSIONS (Height x Width)	HEIGHT (MM) Compared to OEM	R T G V A N W H F C
APRILIA						
DORSODURO 750	08' - 16'	TOURING	4947	330 x 395		(*)
DORSODURO 900	17' - 18'	TOURING	4947	330 x 395		(*)
DORSODURO 1200	11' - 16'	TOURING	4947	330 x 395		(*)
SHIVER 750	07' - 09'	SPORT	4674	330 x 345		(*)
SHIVER 900	17' - 18'	SPORT	4674	330 x 345		(*)
BENELLI						
LEONCINO 500	16' - 18'	SPORT	9747	295 x 258	+110	(*)
LEONCINO TRAIL	17' - 18'	SPORT	9747	295 x 258	+110	(*)
BMW						
F800 R	09' - 14'	SPORT	5051 (-)	330 x 310		(*) (*)
F800 R	15' - 18'	SPORT	7650	310 x 240	+140	(*)
F800 R	15' - 18'	TOURING	8187	430 x 350	+265	(*)
G310 R	16' - 18'	SPORT	8920	305 x 275	+160	(*)
K1300 R	09' - 16'	SPORT	4940	390 x 425	+60	(*)
R1200 R	06' - 14'	SPORT	6488	350 x 320	+130	(*)
R1200 R	15' - 18'	SPORT (1)	7651	365 x 300	+95	(*)
R1200 R	15' - 18'	SPORT (2)	8168	370 x 295	+95	(*)
R1200 R	15' - 18'	TOURING (2)	8110	530 x 360	+250	(*)
R1200 R	15' - 18'	TOURING (1)	8165	525 x 360	+250	(*)
S1000 R	14' - 18'	SPORT	7040	335 x 270	+170	(*) (*)

BMW R1200R 15' - 17'

1

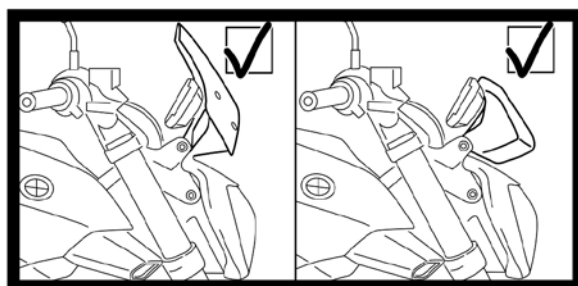

2

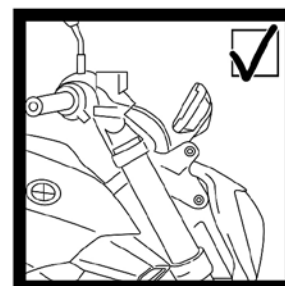

MODEL	YEAR	TYPE	REF.	DIMENSIONS (Height x Width)	HEIGHT (MM) Compared to OEM	R T G V A N W H F C
DUCATI						
DIAVEL	11' - 13'	TOURING	5655 (-)	450 x 355	+65	(*)
DIAVEL	11' - 13'	SPORT	6788 (-)	300 x 250		(*)
DIAVEL	14' - 18'	SPORT	7592 (-)	290 x 235	+65	(*)
DIAVEL	14' - 18'	TOURING	7570 (-)	445 x 350	+65	(*)
X DIAVEL/S	16' - 18'	SPORT	8921	295 x 250		(*)
X DIAVEL/S	16' - 18'	TOURING	8922	450 x 355		(*)
HYPERMOTARD 796	10' - 13'	SPORT	5196	305 x 340		(*)
HYPERMOTARD 1100	07' - 09'	SPORT	5196	305 x 340		(*)
HYPERMOTARD 1100S	10' - 12'	SPORT	5196	305 x 340		(*)
HYPERMOTARD 821/SP	13' - 15'	SPORT	6489	295 x 280	+150	(*)
HYPERMOTARD 939/SP	16' - 18'	SPORT	6489	295 x 280		(*)
MONSTER 696	08' - 14'	SPORT	4672	245 x 240		(*)
MONSTER 796	10' - 14'	SPORT	4672	245 x 240		(*)
MONSTER 797	17' - 18'	SPORT	7013	270 x 280		(*) (*)
MONSTER 797	17' - 18'	TOURING	8900	290 X 180	+100	(*)
MONSTER 821	14' - 18'	SPORT	7013	270 x 280	+100	(*) (*)
MONSTER 821	14' - 18'	TOURING	8900	290 X 180	+100	(*)
MONSTER 1100/S	09' - 10'	SPORT	4672	245 x 240		(*)
MONSTER 1100 EVO	11' - 13'	SPORT	4672	245 x 240		(*)
MONSTER 1200/S	14' - 16'	SPORT	7013	270 x 280	+100	(*) (*)
MONSTER 1200/S	14' - 16'	TOURING	8900	290 X 180	+100	(*)
MONSTER 1200/S	17' - 18'	SPORT	7013	270 x 280	+100	(*) (*)
MONSTER 1200/S	17' - 18'	TOURING	8900	290 X 180	+100	(*)
MONSTER 1200 R	16' - 18'	TOURING	8900	290 X 180	+100	(*)
MONSTER 1200 R	16' - 18'	SPORT	7013	270 x 280	+100	(*)
STREETFIGHTER 848	12' - 15'	SPORT	5054	382 x 270		(*)
STREETFIGHTER 1100	09' - 12'	SPORT	5054	380 x 270		(*)
STREETFIGHTER 1100 S	09' - 13'	SPORT	5054	380 x 270		(*)
HARLEY DAVIDSON						
SPORTSTER 883 IRON	09' - 18'	TOURING	9283	275 x 220		(*)
SPORTSTER 883 SUPERLOW	11' - 18'	TOURING	9283	275 x 220		(*)
SPORTSTER 883 LOW	04' - 10'	TOURING	9283	275 x 220		(*)
SPORTSTER 1200 IRON	18'	TOURING	9283	275 x 220		(*)
SPORTSTER 1200 NIGHTSTER	08' - 12'	TOURING	9283	275 x 220		(*)
SPORTSTER 1200 LOW	07' - 09'	TOURING	9283	275 x 220		(*)
SPORTSTER 1200 CUSTOM	04' - 10'	TOURING	9283	275 x 220		(*)



R Red T Orange G Yellow V Green A Blue N Black W Transparent H Smoke F Dark Smoke C Carbon Look

(*) Check price with your distributor.

(-) Adjustable in width and height.

(#) Support to adjust height on the Naked New Generation windshields: Sport y Touring.

NOTE COLORS: F and N colors delivered without silk print.

IMPORTANT: Indicate code color after part#. Example: 0973A.

WINDSHIELDS SPECIFIC FOR NON-ROUND HEADLIGHTS

HI-TECH PARTS | TYPE OF WINDSHIELD:

2019
MODELS:
www.puig.tv

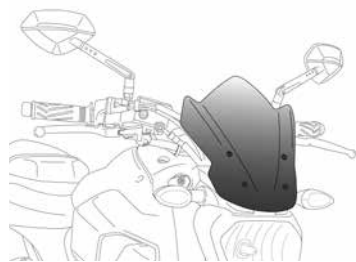

SPORT

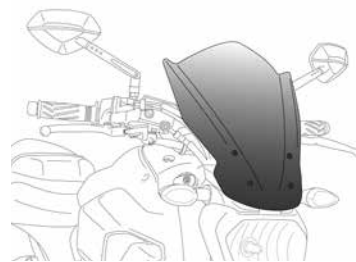

TOURING

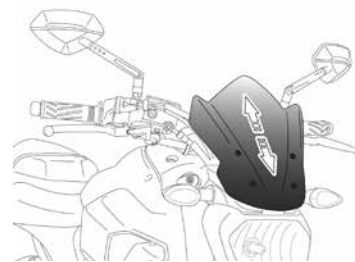

SUPPORT M.E.M.

MODEL	YEAR	TYPE	REF.	DIMENSIONS (Height x Width)	HEIGHT (MM) Compared to OEM	R T G V A N W H F	C
SPORTSTER 1200 CB CUSTOM	13' - 17'	TOURING	9283	275 x 220		(*)	
SPORTSTER FORTY-EIGHT	10' - 18'	TOURING	9283	275 x 220		(*)	
SPORTSTER SEVENTY-TWO	13' - 16'	TOURING	9283	275 x 220		(*)	
HONDA							
CB125R NEO SPORTS CAFE	18'	SPORT	9734	348 x 290	+190	(*)	
CB125F	15' - 18'	SPORT	7726	400 x 340	+270	(*)	
CB300F	15' - 18'	SPORT	7655	295 x 370		(*)	
CB300R NEO SPORTS CAFE	18'	SPORT	9734	348 x 290	+190	(*)	
CB500F	13' - 15'	SPORT	6437	365 x 280	+150	(*)	
CB500F	16' - 18'	SPORT	8923	285 x 295	+155	(*)	
CMX 500 REBEL	17' -18'	TOURING	9462	420 x 360	+200	(*)	
CMX 300 REBEL	17' -18'	TOURING	9462	420 x 360	+200	(*)	
CB600F HORNET	11' - 15'	SPORT	5644	330 x 320		(*)	
CB650F	14' - 16'	SPORT	7010	360 x 280	+220	(*)	
CB650F	17' - 18'	SPORT	9687	300 x 280		(*)	
CB1000R	08' - 10'	SPORT	4673	350 x 340		(*)	(*)
CB1000R	11' - 16'	SPORT	5645	350 x 340		(*)	
CB1000R NEO SPORTS CAFE	18'	SPORT	9748	348 x 290	+190	(*)	
CTX700N	14' - 16'	SPORT	7009	400 x 320		(*)	
HUSQVARNA							
NUDA 900/R	12' - 14'	SPORT	6008	340 x 260	+300	(*)	
701 ENDURO	16' - 18'	SPORT	9867			(*)	
SVARTPILEN 401	17' - 18'	SPORT	9702	320 x 290	+200	(*)	
VITPILEN 401	17' - 18'	SPORT	9702	320 x 290	+200	(*)	
VITPILEN 701	17' - 18'	SPORT	9750			(*)	
INDIAN							
SCOUT	15' - 18'	TOURING	9386	500 x 375		(*)	
KAWASAKI							
ER-6N	05' - 08'	SPORT	4116	330 x 370		(*)	
ER-6N	09' - 11'	SPORT	4950	300 x 255		(*)	
ER-6N	12' - 16'	SPORT	5997	360 x 330	+95	(*)	(*)
VULCAN S	15' - 18'	TOURING	8164	470 x 415	+210	(*)	

MODEL	YEAR	TYPE	REF.	DIMENSIONS (Height x Width)	HEIGHT (MM) Compared to OEM	R T G V A N W H F C
VULCAN S CAFE	17' - 18'	TOURING	8164	470 x 415	+210	(*)
Z250SL	15' - 16'	SPORT	7656	360 x 300		(*)
Z300	15' - 17'	SPORT	7657	310 x 305		(*) (*)
Z650	17' - 18'	SPORT	9588	340 X 220		(*) (*)
Z650	17' - 18'	TOURING	9369	460 X 265		(*)
Z750	07' - 12'	SPORT	4523	370 x 295		(*)
Z750R	11' - 12'	SPORT	4523	370 x 295		(*)
Z800	13' - 16'	SPORT	6401	390 x 270	+200	(*) (*)
Z800E	13' - 16'	SPORT	6401	390 x 270	+200	(*) (*)
Z900	17' - 18'	SPORT	9689	385 x 235		(*) (*)
Z900	17' - 18'	TOURING	9392	395 x 250		(*)
Z900	17' - 18'	SUPPORT M.E.M. (#)	9956N			CHECK WEB
Z1000	10' - 13'	SPORT	5254	425 x 300		(*) (*)
Z1000	14' - 18'	SPORT	7011	355 x 215	+65	(*) (*)
Z1000	14' - 18'	TOURING	7514	430 x 250	+115	(*)
Z1000R	17' - 18'	SPORT	7011	355 x 215	+65	(*) (*)
Z1000R	17' - 18'	TOURING	7514	430 x 250	+115	(*)
KTM						
125 DUKE	11' - 16'	SPORT	6275	250 x 245		(*)
125 DUKE	17' - 18'	SPORT	9514	415 x330	+180	(*)
200 DUKE	12' - 15'	SPORT	6275	250 x 245		(*)
390 DUKE	13' - 16'	SPORT	6275	250 x 245		(*)
390 DUKE	17' - 18'	SPORT	9514	415 x330	+180	(*)
690 DUKE	08' - 11'	SPORT	4941	410 x 355		(*)
690 DUKE	12' - 18'	SPORT	6009	265 x 265	+210	(*)
690 DUKE R	10' - 11'	SPORT	4941	410 x 355		(*)
690 DUKE R	12' - 17'	SPORT	6009	265 x 265		(*)
790 DUKE	18'	SPORT	9668	415 x 330		(*)
950 SUPERMOTO	05' - 07'	SPORT	5053	310 x 315		(*)
950 SUPERMOTO R	07' - 08'	SPORT	5053	310 x 315		(*)
950 SUPERENDURO	06' - 09'	SPORT	5053	310 x 315		(*)
990 SUPERDUKE	07' - 13'	SPORT	4942	290 x 285		(*)
990 SUPERDUKE R	07' - 13'	SPORT	4942	290 x 285		(*)
990 SUPERMOTO	08' - 13'	SPORT	5173	285 x 295		(*)
990 SUPERMOTO R	09' - 13'	SPORT	5173	285 x 295		(*)
1290 SUPERDUKE R	14' - 16'	SPORT	7014	420 x 315	+115	(*)
1290 SUPERDUKE R	14' - 16'	SPORT - WITH GPS KIT SUPPORT	8140	420 x 315	+115	(*)



R Red T Orange G Yellow V Green A Blue N Black W Transparent H Smoke F Dark Smoke C Carbon Look

(*) Check price with your distributor.

(-) Adjustable in width and height.

(#) Support to adjust height on the Naked New Generation windshields: Sport y Touring.

NOTE COLORS: F and N colors delivered without silk print.

IMPORTANT: Indicate code color after part#. Example: 0973A.

WINDSHIELDS SPECIFIC FOR NON-ROUND HEADLIGHTS

HI-TECH PARTS | TYPE OF WINDSHIELD:

2019
MODELS:
www.puig.tv

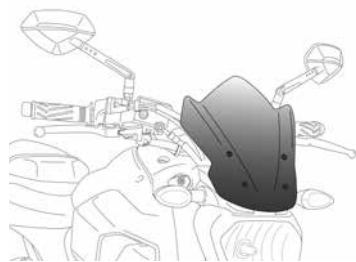

SPORT

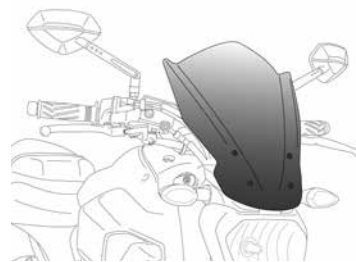

TOURING

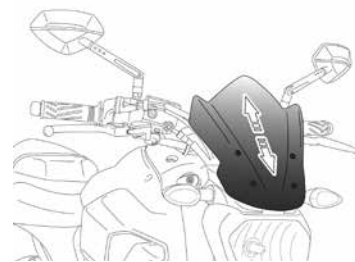

SUPPORT M.E.M.

MODEL	YEAR	TYPE	REF.	DIMENSIONS (Height x Width)	HEIGHT (MM) Compared to OEM	R T G V A N W H F C
1290 SUPERDUKE R	17' - 18'	SPORT	9692	415 x 330	+200	(*)
MV AGUSTA						
BRUTALE	05' - 09'	SPORT	5587	330 x 370		(*)
BRUTALE 675	12' - 18'	SPORT	6010	310 x 315	+170	(*)
BRUTALE 800	13' - 15'	SPORT	6010	310 x 315		(*)
BRUTALE 800	16' - 18'	SPORT	9011	265 X 305		(*)
BRUTALE DRAGSTER 800/RR	14' - 18'	SPORT	6010	310 x 315		(*)
BRUTALE 920	11' - 12'	SPORT	5587	330 x 370		(*)
BRUTALE 1090	10' - 12'	SPORT	5587	330 x 370		(*)
BRUTALE 1090	13' - 18'	SPORT	6400	320 x 310	+150	(*)
BRUTALE 1090 R	10' - 12'	SPORT	5587	330 x 370		(*)
BRUTALE 1090 R	13' - 18'	SPORT	6400	320 x 310		(*)
BRUTALE 1090 RR	10' - 12'	SPORT	5587	330 x 370		(*)
BRUTALE 1090 RR	13' - 18'	SPORT	6400	320 x 310		(*)
RIVALE 800	13' - 18'	SPORT	6499	310 x 315	+170	(*)
RIEJU						
CENTURY 125	18'	SPORT	9774			(*)
SUZUKI						
B-KING	08' - 11'	SPORT	4630	380 x 330		(*) (*)
GSF650 BANDIT	09' - 11'	SPORT	5027	330 x 390		(*)
GSF1250 BANDIT	10' - 13'	SPORT	5027	330 x 390		(*)
GSR600	06' - 11'	SPORT	4117	340 x 280		(*)
GSR750	11' - 16'	SPORT	5646	320 x 300		(*)
GSX-S125	17' - 18'	SPORT	9873	300 x 250	+100	(*)
GSX-S750	17' - 18'	SPORT	9435	330 x 240		(*)
GSX-S750	17' - 18'	TOURING	9436	440 x 315		(*)
GSX-S1000	15' - 18'	SPORT	7653	320 x 260	+175	(*) (*)
SFV650 GLADIUS	09' - 15'	SPORT	4951	300 x 255		(*)
INAZUMA	13' - 17'	SPORT	6251	320 x 260		(*)
TRIUMPH						
BONNEVILLE BOBBER	17' - 18'	TOURING	9437	275 x 215	+170	(*)
BONNEVILLE SPEEDMASTER	18'	TOURING	9437	275 x 215		(*)

MODEL	YEAR	TYPE	REF.	DIMENSIONS (Height x Width)	HEIGHT (MM) Compared to OEM	R T G V A N W H F C	
SPEED TRIPLE	05' - 10'	SPORT	3930	280 x 380		(*)	
SPEED TRIPLE	11' - 15'	SPORT	5658	355 x 270	+110	(*)	
SPEED TRIPLE	16' - 18'	SPORT	8929	320 x 320		(*)	
SPEED TRIPLE R	12' - 15'	SPORT	5658	355 x 270		(*)	
SPEED TRIPLE R	16' - 18'	SPORT	8929	320 x 320		(*)	
STREET TRIPLE	07' - 10'	SPORT	3930	280 x 380		(*)	
STREET TRIPLE	13' - 16'	SPORT	5658	355 x 270		(*)	
STREET TRIPLE	17' - 18'	SPORT	8929	320 x 320		(*)	
STREET TRIPLE R	08' - 10'	SPORT	3930	280 x 380		(*)	
STREET TRIPLE R	13' - 16'	SPORT	5658	355 x 270		(*)	
STREET TRIPLE R	17' - 18'	SPORT	8929	320 x 320		(*)	(*)
STREET TRIPLE RS	17' - 18'	SPORT	8929	320 x 320		(*)	(*)
STREET TRIPLE S	17' - 18'	SPORT	9999	310 x 330	+120	(*)	
YAMAHA							
FZ6	04' - 08'	SPORT	1995	360 x 330		(*)	
FZ6 S2	07' - 10'	SPORT	4511	330 x 370		(*)	
FZ8	10' - 16'	SPORT	5872	300 x 290		(*)	
FZ1	06' - 15'	SPORT	4119	320 x 330		(*)	
MT-125	14' - 18'	SPORT	7654	320 x 260		(*)	
MT-03	16' - 18'	TOURING	8932	330 x 280	+170	(*)	
MT-07	14' - 17'	SPORT	7015	295 x 250	+180	(*)	(*)
MT-07	14' - 17'	TOURING	7016	380 x 300	+260	(*)	
MT-07	18'	SPORT	9666	230 x 235	+100	(*)	(*)
MT-07	18'	TOURING	9667	360 x 288	+230	(*)	
MT-09	13' - 16'	SPORT	6859	290 x 300		(*)	
MT-09	13' - 16'	TOURING	6861	350 x 290	+60	(*)	
MT-09	17' - 18'	SPORT	9376	290 x 270		(*)	
MT-09	17' - 18'	TOURING	9377	420 x 305		(*)	
MT-09	17' - 18'	SUPPORT M.E.M. (#)	9955N			CHECK WEB	
MT-09 SP	18'	SPORT	9376	290 x 270		(*)	
MT-09 SP	18'	TOURING	9377	420 x 305		(*)	
MT-09 SP	18'	SUPPORT M.E.M. (#)	9955N			CHECK WEB	
VMAX	09' - 16'	SPORT	4952	420 x 480		(*)	
XJ6	09' - 16'	SPORT	5026	325 x 270		(*)	
XT660X	07' - 16'	SPORT	4358	255 x 315		(*)	
XV950	14' - 18'	TOURING	9438	420 x 360	+240	(*)	
XV950R	14' - 18'	TOURING	9438	420 x 360	+240	(*)	
XV950 RACER	16' - 18'	TOURING	9438	420 x 360	+240	(*)	



R Red T Orange G Yellow V Green A Blue N Black W Transparent H Smoke F Dark Smoke C Carbon Look

(*) Check price with your distributor.

(-) Adjustable in width and height.

(#) Support to adjust height on the Naked New Generation windshields: Sport y Touring.

NOTE COLORS: F and N colors delivered without silk print.

IMPORTANT: Indicate code color after part#. Example: 0973A.



// BAT

MODEL	REFERENCE	PRICE
BAT UNIVERSAL	8088	(*)

FOR SPECIFIC MODELS SEE PAGE 68

SPECIFIC MULTIADJUSTABLE VISOR FOR BAT WINDSHIELD CHECK WEB

IMPORTANT: Indicate code color after part#. Example: 0973A.

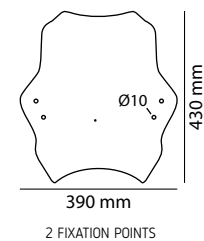



// RAFALE

MODEL	REFERENCE	PRICE
RAFALE UNIVERSAL	5881	(*)

FOR SPECIFIC MODELS SEE PAGE 68

SPECIFIC MULTIADJUSTABLE VISOR FOR RAFALE WINDSHIELD [CHECK WEB](#)

IMPORTANT: Indicate code color after part#. Example: 0973A.



R
Red



T
Orange



G
Yellow



V
Green



A
Blue



N
Black



H
Smoke



W
Transparent



F
Dark Smoke



2 FIXATION POINTS



// STREAM

MODEL	REFERENCE	PRICE
STREAM UNIVERSAL	5022	(*)

FOR SPECIFIC MODELS SEE PAGE 68

SPECIFIC MULTIADJUSTABLE VISOR FOR STREAM WINDSHIELD [CHECK WEB](#)

IMPORTANT: Indicate code color after part#. Example: 0973A.



A
Blue

N
Black



H
Smoke

F
Dark Smoke

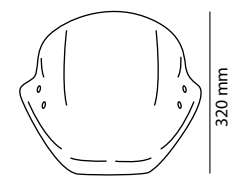

410 mm

2 FIXATION POINTS



// STREAM WITH VISOR UNIVERSAL

MODEL	REFERENCE	PRICE
STREAM WITH VISOR UNIVERSAL	5920	(*)

FOR SPECIFIC MODELS [SEE PAGE 68](#)

SPECIFIC MULTIADJUSTABLE VISOR FOR STREAM WITH VISOR WINDSHIELD [CHECK WEB](#)

IMPORTANT: Indicate code color after part#. Example: 0973A.



H
Smoke

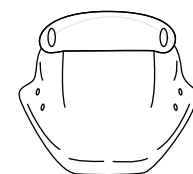

410 mm

2 FIXATION POINTS

320 mm



// UP&DOWN

MODEL	REFERENCE	PRICE
UP&DOWN UNIVERSAL	2193	(*)

FOR SPECIFIC MODELS SEE PAGE 68

SPECIFIC MULTIADJUSTABLE VISOR FOR UP&DOWN WINDSHIELD CHECK WEB

IMPORTANT: Indicate code color after part#. Example: 0973A.



H
Smoke



W
Transparent



ABE
38007

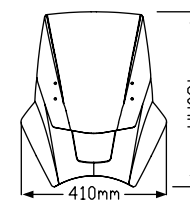

2 FIXATION POINTS



// TOURING II

MODEL	REFERENCE	W	H
TOURING II UNIVERSAL	5267	(*)	(*)

FOR SPECIFIC MODELS SEE PAGE 68

SPECIFIC MULTIADJUSTABLE VISOR FOR TOURING II WINDSHIELD CHECK WEB

IMPORTANT: Indicate code color after part#. Example: 0973A.



H
Smoke



W
Transparent



ABE
38007

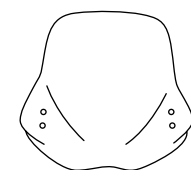







535 mm

480 mm

2 FIXATION POINTS

MODEL	YEAR	TYPE OF WINDSHIELD	REF.	H	
LEONCINO 500	16' - 18'	STREAM	5022	(*)	(*)
LEONCINO 500	16' - 18'	STREAM WITH VISOR	5920H	(*)	
LEONCINO 500	16' - 18'	RAFALE	5881	(*)	(*)
LEONCINO 500	16' - 18'	BAT	8088	(*)	(*)
LEONCINO 500	16' - 18'	TOURING II	5267	(*)	(*)
LEONCINO 500	16' - 18'	UP&DOWN	2193	(*)	(*)
BMW					
G310 R	16' - 18'	STREAM	5022	(*)	(*)
G310 R	16' - 18'	STREAM WITH VISOR	5920H	(*)	
G310 R	16' - 18'	RAFALE	5881	(*)	(*)
G310 R	16' - 18'	BAT	8088	(*)	(*)
G310 R	16' - 18'	TOURING II	5267	(*)	(*)
G310 R	16' - 18'	UP&DOWN	2193	(*)	(*)
F800 R	09' - 14'	STREAM	5022	(*)	(*)
F800 R	09' - 14'	STREAM WITH VISOR	5920H	(*)	
F800 R	09' - 14'	RAFALE	5881	(*)	(*)
F800 R	09' - 14'	BAT	8088	(*)	(*)
F800 R	09' - 14'	TOURING II	5267	(*)	(*)
F800 R	09' - 14'	UP&DOWN	2193	(*)	(*)
S1000 R	14' - 18'	STREAM	5022	(*)	(*)
S1000 R	14' - 18'	STREAM WITH VISOR	5920H	(*)	
S1000 R	14' - 18'	RAFALE	5881	(*)	(*)
S1000 R	14' - 18'	BAT	8088	(*)	(*)
S1000 R	14' - 18'	TOURING II	5267	(*)	(*)
S1000 R	14' - 18'	UP&DOWN	2193	(*)	(*)
R NINE T	14' - 18'	STREAM	5022	(*)	(*)
R NINE T	14' - 18'	STREAM WITH VISOR	5920H	(*)	
R NINE T	14' - 18'	RAFALE	5881	(*)	(*)
R NINE T	14' - 18'	BAT	8088	(*)	(*)
R NINE T	14' - 18'	TOURING II	5267	(*)	(*)
R NINE T	14' - 18'	UP&DOWN	2193	(*)	(*)
R NINE T PURE	17' - 18'	STREAM	5022	(*)	(*)
R NINE T PURE	17' - 18'	STREAM WITH VISOR	5920H	(*)	
R NINE T PURE	17' - 18'	RAFALE	5881	(*)	(*)
R NINE T PURE	17' - 18'	BAT	8088	(*)	(*)

	COLORS: BAT
	COLORS: RAFALE
	COLORS: STREAM
	COLORS: STREAM WITH VISOR
	COLORS: UP&DOWN
	COLORS: TOURING II

(*) Check price with your distributor.

IMPORTANT: Indicate code color after part#. Example: 0973A.



BAT



RAFALE



STREAM

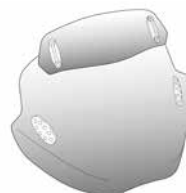

STREAM WITH VISOR









UP&DOWN



TOURING II

MODEL	YEAR	TYPE OF WINDSHIELD	REF.	H	R A	T N	G W	V F
R NINE T PURE	17' - 18'	TOURING II	5267	(*)				(*)
R NINE T PURE	17' - 18'	UP&DOWN	2193	(*)				(*)
R NINE T URBAN G/S	17' - 18'	STREAM	5022	(*)				(*)
R NINE T URBAN G/S	17' - 18'	STREAM WITH VISOR	5920H	(*)				
R NINE T URBAN G/S	17' - 18'	BAT	8088	(*)				(*)
R NINE T URBAN G/S	17' - 18'	TOURING II	5267	(*)				(*)
R NINE T URBAN G/S	17' - 18'	UP&DOWN	2193	(*)				(*)
DUCATI								
DIAVEL	11' - 18'	STREAM	5022	(*)				(*)
DIAVEL	11' - 18'	STREAM WITH VISOR	5920H	(*)				
DIAVEL	11' - 18'	RAFALE	5881	(*)				(*)
DIAVEL	11' - 18'	BAT	8088	(*)				(*)
DIAVEL	11' - 18'	TOURING II	5267	(*)				(*)
DIAVEL	11' - 18'	UP&DOWN	2193	(*)				(*)
HYPERMOTARD 796	10' - 13'	STREAM	5022	(*)				(*)
HYPERMOTARD 796	10' - 13'	STREAM WITH VISOR	5920H	(*)				
HYPERMOTARD 796	10' - 13'	RAFALE	5881	(*)				(*)
HYPERMOTARD 796	10' - 13'	BAT	8088	(*)				(*)
HYPERMOTARD 796	10' - 13'	TOURING II	5267	(*)				(*)
HYPERMOTARD 796	10' - 13'	UP&DOWN	2193	(*)				(*)
HYPERMOTARD 939/SP	16' - 18'	STREAM	5022	(*)				(*)
HYPERMOTARD 939/SP	16' - 18'	STREAM WITH VISOR	5920H	(*)				
HYPERMOTARD 939/SP	16' - 18'	RAFALE	5881	(*)				(*)
HYPERMOTARD 939/SP	16' - 18'	BAT	8088	(*)				(*)
HYPERMOTARD 939/SP	16' - 18'	TOURING II	5267	(*)				(*)
HYPERMOTARD 939/SP	16' - 18'	UP&DOWN	2193	(*)				(*)
HYPERMOTARD 1100	07' - 09'	STREAM	5022	(*)				(*)
HYPERMOTARD 1100	07' - 09'	STREAM WITH VISOR	5920H	(*)				
HYPERMOTARD 1100	07' - 09'	RAFALE	5881	(*)				(*)
HYPERMOTARD 1100	07' - 09'	BAT	8088	(*)				(*)
HYPERMOTARD 1100	07' - 09'	TOURING II	5267	(*)				(*)
HYPERMOTARD 1100	07' - 09'	UP&DOWN	2193	(*)				(*)

MODEL	YEAR	TYPE OF WINDSHIELD	REF.	H	
HYPERMOTARD 1100S	10' - 12'	STREAM	5022	(*)	(*)
HYPERMOTARD 1100S	10' - 12'	STREAM WITH VISOR	5920H	(*)	
HYPERMOTARD 1100S	10' - 12'	RAFALE	5881	(*)	(*)
HYPERMOTARD 1100S	10' - 12'	BAT	8088	(*)	(*)
HYPERMOTARD 1100S	10' - 12'	TOURING II	5267	(*)	(*)
HYPERMOTARD 1100S	10' - 12'	UP&DOWN	2193	(*)	(*)
MONSTER 696	08' - 14'	STREAM	5022	(*)	(*)
MONSTER 696	08' - 14'	STREAM WITH VISOR	5920H	(*)	
MONSTER 696	08' - 14'	RAFALE	5881	(*)	(*)
MONSTER 696	08' - 14'	BAT	8088	(*)	(*)
MONSTER 696	08' - 14'	TOURING II	5267	(*)	(*)
MONSTER 696	08' - 14'	UP&DOWN	2193	(*)	(*)
MONSTER 797	17' - 18'	STREAM	5022	(*)	(*)
MONSTER 797	17' - 18'	STREAM WITH VISOR	5920H	(*)	
MONSTER 797	17' - 18'	RAFALE	5881	(*)	(*)
MONSTER 797	17' - 18'	BAT	8088	(*)	(*)
MONSTER 797	17' - 18'	TOURING II	5267	(*)	(*)
MONSTER 797	17' - 18'	UP&DOWN	2193	(*)	(*)
MONSTER 821	14' - 18'	STREAM	5022	(*)	(*)
MONSTER 821	14' - 18'	STREAM WITH VISOR	5920H	(*)	
MONSTER 821	14' - 18'	TOURING II	5267	(*)	(*)
MONSTER 821	14' - 18'	UP&DOWN	2193	(*)	(*)
MONSTER 1100	09' - 10'	STREAM	5022	(*)	(*)
MONSTER 1100	09' - 10'	STREAM WITH VISOR	5920H	(*)	
MONSTER 1100	09' - 10'	RAFALE	5881	(*)	(*)
MONSTER 1100	09' - 10'	BAT	8088	(*)	(*)
MONSTER 1100	09' - 10'	TOURING II	5267	(*)	(*)
MONSTER 1100	09' - 10'	UP&DOWN	2193	(*)	(*)
MONSTER 1100 EVO	11' - 13'	STREAM	5022	(*)	(*)
MONSTER 1100 EVO	11' - 13'	STREAM WITH VISOR	5920H	(*)	
MONSTER 1100 EVO	11' - 13'	RAFALE	5881	(*)	(*)
MONSTER 1100 EVO	11' - 13'	BAT	8088	(*)	(*)
MONSTER 1100 EVO	11' - 13'	TOURING II	5267	(*)	(*)
MONSTER 1100 EVO	11' - 13'	UP&DOWN	2193	(*)	(*)
MONSTER 1200/S	14' - 16'	STREAM	5022	(*)	(*)

 COLORS: **BAT**
 COLORS: **RAFALE**
 COLORS: **STREAM**
 COLORS: **STREAM WITH VISOR**
 COLORS: **UP&DOWN**
 COLORS: **TOURING II**

(*) Check price with your distributor.

IMPORTANT: Indicate code color after part#. Example: 0973A.



BAT



RAFALE



STREAM

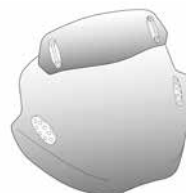

STREAM WITH VISOR









UP&DOWN



TOURING II

MODEL	YEAR	TYPE OF WINDSHIELD	REF.	H	R A	T N	G W	V F
MONSTER 1200/S	14' - 16'	STREAM WITH VISOR	5920H	(*)				
MONSTER 1200/S	14' - 16'	RAFALE	5881	(*)				(*)
MONSTER 1200/S	14' - 16'	BAT	8088	(*)				(*)
MONSTER 1200/S	14' - 16'	TOURING II	5267	(*)				(*)
MONSTER 1200/S	14' - 16'	UP&DOWN	2193	(*)				(*)
MONSTER 1200/S	17' - 18'	STREAM	5022	(*)				(*)
MONSTER 1200/S	17' - 18'	STREAM WITH VISOR	5920H	(*)				
MONSTER 1200/S	17' - 18'	RAFALE	5881	(*)				(*)
MONSTER 1200/S	17' - 18'	BAT	8088	(*)				(*)
MONSTER 1200/S	17' - 18'	UP&DOWN	2193	(*)				(*)
SCRAMBLER ICON/CLASSIC/FULL THROTTLE	15' - 18'	STREAM	5022	(*)				(*)
SCRAMBLER ICON/CLASSIC/FULL THROTTLE	15' - 18'	STREAM WITH VISOR	5920H	(*)				
SCRAMBLER ICON/CLASSIC/FULL THROTTLE	15' - 18'	RAFALE	5881	(*)				(*)
SCRAMBLER ICON/CLASSIC/FULL THROTTLE	15' - 18'	BAT	8088	(*)				(*)
SCRAMBLER ICON/CLASSIC/FULL THROTTLE	15' - 18'	TOURING II	5267	(*)				(*)
SCRAMBLER ICON/CLASSIC/FULL THROTTLE	15' - 18'	UP&DOWN	2193	(*)				(*)
SCRAMBLER SIXTY2	16' - 18'	STREAM	5022	(*)				(*)
SCRAMBLER SIXTY2	16' - 18'	STREAM WITH VISOR	5920H	(*)				
SCRAMBLER SIXTY2	16' - 18'	RAFALE	5881	(*)				(*)
SCRAMBLER SIXTY2	16' - 18'	BAT	8088	(*)				(*)
SCRAMBLER SIXTY2	16' - 18'	TOURING II	5267	(*)				(*)
SCRAMBLER SIXTY2	16' - 18'	UP&DOWN	2193	(*)				(*)
SCRAMBLER URBAN ENDURO	15'- 16'	STREAM	5022	(*)				(*)
SCRAMBLER URBAN ENDURO	15'- 16'	STREAM WITH VISOR	5920H	(*)				
SCRAMBLER URBAN ENDURO	15'- 16'	RAFALE	5881	(*)				(*)
SCRAMBLER URBAN ENDURO	15'- 16'	BAT	8088	(*)				(*)
SCRAMBLER URBAN ENDURO	15'- 16'	TOURING II	5267	(*)				(*)
SCRAMBLER URBAN ENDURO	15'- 16'	UP&DOWN	2193	(*)				(*)
SCRAMBLER FLAT TRACK PRO	16'	STREAM	5022	(*)				(*)
SCRAMBLER FLAT TRACK PRO	16'	STREAM WITH VISOR	5920H	(*)				
SCRAMBLER FLAT TRACK PRO	16'	RAFALE	5881	(*)				(*)
SCRAMBLER FLAT TRACK PRO	16'	BAT	8088	(*)				(*)

MODEL	YEAR	TYPE OF WINDSHIELD	REF.	H	
SCRAMBLER FLAT TRACK PRO	16'	TOURING II	5267	(*)	(*)
SCRAMBLER FLAT TRACK PRO	16'	UP&DOWN	2193	(*)	(*)
SCRAMBLER CAFE RACER	17' - 18'	STREAM	5022	(*)	(*)
SCRAMBLER CAFE RACER	17' - 18'	STREAM WITH VISOR	5920H	(*)	
SCRAMBLER CAFE RACER	17' - 18'	RAFALE	5881	(*)	(*)
SCRAMBLER CAFE RACER	17' - 18'	BAT	8088	(*)	(*)
SCRAMBLER CAFE RACER	17' - 18'	TOURING II	5267	(*)	(*)
SCRAMBLER CAFE RACER	17' - 18'	UP&DOWN	2193	(*)	(*)
SCRAMBLER 1100	18'	STREAM	5022	(*)	(*)
SCRAMBLER 1100	18'	STREAM WITH VISOR	5920H	(*)	
SCRAMBLER 1100	18'	BAT	8088	(*)	(*)
SCRAMBLER 1100	18'	TOURING II	5267	(*)	(*)
SCRAMBLER 1100	18'	UP&DOWN	2193	(*)	(*)
SCRAMBLER 1100 SPORT	18'	STREAM	5022	(*)	(*)
SCRAMBLER 1100 SPORT	18'	STREAM WITH VISOR	5920H	(*)	
SCRAMBLER 1100 SPORT	18'	BAT	8088	(*)	(*)
SCRAMBLER 1100 SPORT	18'	TOURING II	5267	(*)	(*)
SCRAMBLER 1100 SPORT	18'	UP&DOWN	2193	(*)	(*)
SCRAMBLER 1100 SPECIAL	18'	STREAM	5022	(*)	(*)
SCRAMBLER 1100 SPECIAL	18'	STREAM WITH VISOR	5920H	(*)	
SCRAMBLER 1100 SPECIAL	18'	BAT	8088	(*)	(*)
SCRAMBLER 1100 SPECIAL	18'	TOURING II	5267	(*)	(*)
SCRAMBLER 1100 SPECIAL	18'	UP&DOWN	2193	(*)	(*)
STREETFIGHTER 1100	09' - 12'	STREAM	5022	(*)	(*)
STREETFIGHTER 1100	09' - 12'	STREAM WITH VISOR	5920H	(*)	
STREETFIGHTER 1100	09' - 12'	RAFALE	5881	(*)	(*)
STREETFIGHTER 1100	09' - 12'	BAT	8088	(*)	(*)
STREETFIGHTER 1100	09' - 12'	TOURING II	5267	(*)	(*)
STREETFIGHTER 1100	09' - 12'	UP&DOWN	2193	(*)	(*)
STREETFIGHTER 1100 S	09' - 13'	STREAM	5022	(*)	(*)
STREETFIGHTER 1100 S	09' - 13'	STREAM WITH VISOR	5920H	(*)	
STREETFIGHTER 1100 S	09' - 13'	RAFALE	5881	(*)	(*)
STREETFIGHTER 1100 S	09' - 13'	BAT	8088	(*)	(*)
STREETFIGHTER 1100 S	09' - 13'	TOURING II	5267	(*)	(*)
STREETFIGHTER 1100 S	09' - 13'	UP&DOWN	2193	(*)	(*)

	COLORS: BAT
	COLORS: RAFALE
	COLORS: STREAM
	COLORS: STREAM WITH VISOR
	COLORS: UP&DOWN
	COLORS: TOURING II

(*) Check price with your distributor.

IMPORTANT: Indicate code color after part#. Example: 0973A.



BAT



RAFALE



STREAM

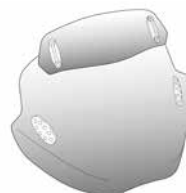

STREAM WITH VISOR









UP&DOWN



TOURING II

MODEL	YEAR	TYPE OF WINDSHIELD	REF.	H	R A	T N	G W	V F
HONDA								
CB125F	15' - 18'	STREAM	5022	(*)				(*)
CB125F	15' - 18'	STREAM WITH VISOR	5920H	(*)				
CB125F	15' - 18'	RAFALE	5881	(*)				(*)
CB125F	15' - 18'	BAT	8088	(*)				(*)
CB125F	15' - 18'	TOURING II	5267	(*)				(*)
CB125F	15' - 18'	UP&DOWN	2193	(*)				(*)
CB300F	15' - 16'	STREAM	5022	(*)				(*)
CB300F	15' - 16'	STREAM WITH VISOR	5920H	(*)				
CB300F	15' - 16'	RAFALE	5881	(*)				(*)
CB300F	15' - 16'	BAT	8088	(*)				(*)
CB300F	15' - 16'	TOURING II	5267	(*)				(*)
CB300F	15' - 16'	UP&DOWN	2193	(*)				(*)
CB500F	13' - 18'	STREAM	5022	(*)				(*)
CB500F	13' - 18'	STREAM WITH VISOR	5920H	(*)				
CB500F	13' - 18'	RAFALE	5881	(*)				(*)
CB500F	13' - 18'	BAT	8088	(*)				(*)
CB500F	13' - 18'	TOURING II	5267	(*)				(*)
CB500F	13' - 18'	UP&DOWN	2193	(*)				(*)
CB125R NEO SPORTS CAFE	18'	STREAM	5022	(*)				(*)
CB125R NEO SPORTS CAFE	18'	STREAM WITH VISOR	5920H	(*)				
CB125R NEO SPORTS CAFE	18'	BAT	8088	(*)				(*)
CB125R NEO SPORTS CAFE	18'	TOURING II	5267	(*)				(*)
CB125R NEO SPORTS CAFE	18'	UP&DOWN	2193	(*)				(*)
CB300R NEO SPORTS CAFE	18'	STREAM	5022	(*)				(*)
CB300R NEO SPORTS CAFE	18'	STREAM WITH VISOR	5920H	(*)				
CB300R NEO SPORTS CAFE	18'	BAT	8088	(*)				(*)
CB300R NEO SPORTS CAFE	18'	TOURING II	5267	(*)				(*)
CB300R NEO SPORTS CAFE	18'	UP&DOWN	2193	(*)				(*)
CB600F HORNET	98' - 15'	STREAM	5022	(*)				(*)
CB600F HORNET	98' - 15'	STREAM WITH VISOR	5920H	(*)				
CB600F HORNET	98' - 15'	RAFALE	5881	(*)				(*)

MODEL	YEAR	TYPE OF WINDSHIELD	REF.	H	
CB600F HORNET	98' - 15'	BAT	8088	(*)	(*)
CB600F HORNET	98' - 15'	TOURING II	5267	(*)	(*)
CB600F HORNET	98' - 15'	UP&DOWN	2193	(*)	(*)
CB650F	14' - 18'	STREAM	5022	(*)	(*)
CB650F	14' - 18'	STREAM WITH VISOR	5920H	(*)	
CB650F	14' - 18'	RAFALE	5881	(*)	(*)
CB650F	14' - 18'	BAT	8088	(*)	(*)
CB650F	14' - 18'	TOURING II	5267	(*)	(*)
CB650F	14' - 18'	UP&DOWN	2193	(*)	(*)
CB900F HORNET	02' - 05'	STREAM	5022	(*)	(*)
CB900F HORNET	02' - 05'	STREAM WITH VISOR	5920H	(*)	
CB900F HORNET	02' - 05'	RAFALE	5881	(*)	(*)
CB900F HORNET	02' - 05'	BAT	8088	(*)	(*)
CB900F HORNET	02' - 05'	TOURING II	5267	(*)	(*)
CB900F HORNET	02' - 05'	UP&DOWN	2193	(*)	(*)
CB1000R	08' - 16'	STREAM	5022	(*)	(*)
CB1000R	08' - 16'	STREAM WITH VISOR	5920H	(*)	
CB1000R	08' - 16'	RAFALE	5881	(*)	(*)
CB1000R	08' - 16'	BAT	8088	(*)	(*)
CB1000R	08' - 16'	TOURING II	5267	(*)	(*)
CB1000R	08' - 16'	UP&DOWN	2193	(*)	(*)
CB1000R NEO SPORTS CAFE	18'	STREAM	5022	(*)	(*)
CB1000R NEO SPORTS CAFE	18'	STREAM WITH VISOR	5920H	(*)	
CB1000R NEO SPORTS CAFE	18'	BAT	8088	(*)	(*)
CB1000R NEO SPORTS CAFE	18'	TOURING II	5267	(*)	(*)
CB1000R NEO SPORTS CAFE	18'	UP&DOWN	2193	(*)	(*)
CB1100	13' - 14'	STREAM	5022	(*)	(*)
CB1100	13' - 14'	STREAM WITH VISOR	5920H	(*)	
CB1100	13' - 14'	RAFALE	5881	(*)	(*)
CB1100	13' - 14'	BAT	8088	(*)	(*)
CB1100	13' - 14'	TOURING II	5267	(*)	(*)
CB1100	13' - 14'	UP&DOWN	2193	(*)	(*)
CB1100EX	14' - 18'	STREAM	5022	(*)	(*)
CB1100EX	14' - 18'	STREAM WITH VISOR	5920H	(*)	
CB1100EX	14' - 18'	BAT	8088	(*)	(*)

 COLORS: BAT
 COLORS: RAFALE
 COLORS: STREAM
 COLORS: STREAM WITH VISOR
 COLORS: UP&DOWN
 COLORS: TOURING II

(*) Check price with your distributor.

IMPORTANT: Indicate code color after part#. Example: 0973A.



BAT



RAFALE



STREAM

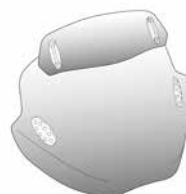

STREAM WITH VISOR

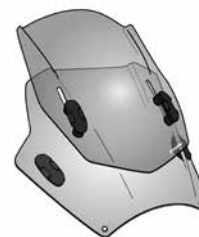







UP&DOWN



TOURING II

MODEL	YEAR	TYPE OF WINDSHIELD	REF.	H	R T G V A N W F
CB1100RS	14' - 18'	TOURING II	5267	(*)	(*)
CB1100RS	14' - 18'	UP&DOWN	2193	(*)	(*)
CB1100RS	17' - 18'	STREAM	5022	(*)	(*)
CB1100RS	17' - 18'	STREAM WITH VISOR	5920H	(*)	
CB1100RS	17' - 18'	BAT	8088	(*)	(*)
CB1100RS	17' - 18'	TOURING II	5267	(*)	(*)
CB1100RS	17' - 18'	UP&DOWN	2193	(*)	(*)
CB1300	03' - 10'	STREAM	5022	(*)	(*)
CB1300	03' - 10'	STREAM WITH VISOR	5920H	(*)	
CB1300	03' - 10'	RAFALE	5881	(*)	(*)
CB1300	03' - 10'	BAT	8088	(*)	(*)
CB1300	03' - 10'	TOURING II	5267	(*)	(*)
CB1300	03' - 10'	UP&DOWN	2193	(*)	(*)
CBF500	04' - 07'	STREAM	5022	(*)	(*)
CBF500	04' - 07'	STREAM WITH VISOR	5920H	(*)	
CBF500	04' - 07'	RAFALE	5881	(*)	(*)
CBF500	04' - 07'	BAT	8088	(*)	(*)
CBF500	04' - 07'	TOURING II	5267	(*)	(*)
CBF500	04' - 07'	UP&DOWN	2193	(*)	(*)
CBF600	04' - 14'	STREAM	5022	(*)	(*)
CBF600	04' - 14'	STREAM WITH VISOR	5920H	(*)	
CBF600	04' - 14'	RAFALE	5881	(*)	(*)
CBF600	04' - 14'	BAT	8088	(*)	(*)
CBF600	04' - 14'	TOURING II	5267	(*)	(*)
CBF600	04' - 14'	UP&DOWN	2193	(*)	(*)
CMX 500 REBEL	17' - 18'	STREAM	5022	(*)	(*)
CMX 500 REBEL	17' - 18'	STREAM WITH VISOR	5920H	(*)	
CMX 500 REBEL	17' - 18'	BAT	8088	(*)	(*)
CMX 500 REBEL	17' - 18'	TOURING II	5267	(*)	(*)
CMX 500 REBEL	17' - 18'	UP&DOWN	2193	(*)	(*)
CMX 300 REBEL	17' - 18'	STREAM	5022	(*)	(*)
CMX 300 REBEL	17' - 18'	STREAM WITH VISOR	5920H	(*)	

MODEL	YEAR	TYPE OF WINDSHIELD	REF.	H	
CMX 300 REBEL	17' - 18'	BAT	8088	(*)	(*)
CMX 300 REBEL	17' - 18'	TOURING II	5267	(*)	(*)
CMX 300 REBEL	17' - 18'	UP&DOWN	2193	(*)	(*)
CTX700N	14' - 16'	STREAM	5022	(*)	(*)
CTX700N	14' - 16'	STREAM WITH VISOR	5920H	(*)	
CTX700N	14' - 16'	RAFALE	5881	(*)	(*)
CTX700N	14' - 16'	BAT	8088	(*)	(*)
CTX700N	14' - 16'	TOURING II	5267	(*)	(*)
CTX700N	14' - 16'	UP&DOWN	2193	(*)	(*)
MSX125	13' - 18'	STREAM	5022	(*)	(*)
MSX125	13' - 18'	STREAM WITH VISOR	5920H	(*)	
MSX125	13' - 18'	RAFALE	5881	(*)	(*)
MSX125	13' - 18'	BAT	8088	(*)	(*)
MSX125	13' - 18'	UP&DOWN	2193	(*)	(*)
HUSQVARNA					
NUDA 900/R	12' - 14'	STREAM	5022	(*)	(*)
NUDA 900/R	12' - 14'	STREAM WITH VISOR	5920H	(*)	
NUDA 900/R	12' - 14'	RAFALE	5881	(*)	(*)
NUDA 900/R	12' - 14'	BAT	8088	(*)	(*)
NUDA 900/R	12' - 14'	TOURING II	5267	(*)	(*)
NUDA 900/R	12' - 14'	UP&DOWN	2193	(*)	(*)
INDIAN					
SCOUT BOBBER	18'	STREAM	5022	(*)	(*)
SCOUT BOBBER	18'	STREAM WITH VISOR	5920H	(*)	
SCOUT BOBBER	18'	BAT	8088	(*)	(*)
SCOUT BOBBER	18'	TOURING II	5267	(*)	(*)
SCOUT BOBBER	18'	UP&DOWN	2193	(*)	(*)
KAWASAKI					
ER-5	96' - 06'	STREAM	5022	(*)	(*)
ER-5	96' - 06'	STREAM WITH VISOR	5920H	(*)	
ER-5	96' - 06'	RAFALE	5881	(*)	(*)
ER-5	96' - 06'	BAT	8088	(*)	(*)
ER-5	96' - 06'	TOURING II	5267	(*)	(*)
ER-5	96' - 06'	UP&DOWN	2193	(*)	(*)
ER-6N	05' - 11'	STREAM	5022	(*)	(*)

	COLORS: BAT
	COLORS: RAFALE
	COLORS: STREAM
	COLORS: STREAM WITH VISOR
	COLORS: UP&DOWN
	COLORS: TOURING II

(*) Check price with your distributor.

IMPORTANT: Indicate code color after part#. Example: 0973A.



BAT



RAFALE



STREAM

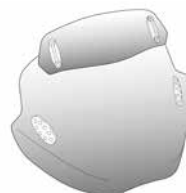

STREAM WITH VISOR









UP&DOWN



TOURING II

MODEL	YEAR	TYPE OF WINDSHIELD	REF.	H	R A	T N	G W	V F
ER-6N	05' - 11'	STREAM WITH VISOR	5920H	(*)				
ER-6N	05' - 11'	RAFALE	5881	(*)				(*)
ER-6N	05' - 11'	BAT	8088	(*)				(*)
ER-6N	05' - 11'	TOURING II	5267	(*)				(*)
ER-6N	05' - 11'	UP&DOWN	2193	(*)				(*)
ER-6N	12' - 16'	STREAM	6407	(*)				(*)
ER-6N	12' - 16'	STREAM WITH VISOR	6408H	(*)				
ER-6N	12' - 16'	RAFALE	6409	(*)				(*)
ER-6N	12' - 16'	BAT	9987	(*)				(*)
ER-6N	12' - 16'	TOURING II	6410	(*)				(*)
ER-6N	12' - 16'	UP&DOWN	1948	(*)				(*)
VULCAN S	15' - 18'	STREAM	5022	(*)				(*)
VULCAN S	15' - 18'	STREAM WITH VISOR	5920H	(*)				
VULCAN S	15' - 18'	RAFALE	5881	(*)				(*)
VULCAN S	15' - 18'	BAT	8088	(*)				(*)
VULCAN S	15' - 18'	TOURING II	5267	(*)				(*)
VULCAN S	15' - 18'	UP&DOWN	2193	(*)				(*)
VULCAN S CAFE	17' - 18'	STREAM	5022	(*)				(*)
VULCAN S CAFE	17' - 18'	STREAM WITH VISOR	5920H	(*)				
VULCAN S CAFE	17' - 18'	RAFALE	5881	(*)				(*)
VULCAN S CAFE	17' - 18'	BAT	8088	(*)				(*)
VULCAN S CAFE	17' - 18'	TOURING II	5267	(*)				(*)
VULCAN S CAFE	17' - 18'	UP&DOWN	2193	(*)				(*)
W650	99' - 06'	STREAM	5022	(*)				(*)
W650	99' - 06'	STREAM WITH VISOR	5920H	(*)				
W650	99' - 06'	RAFALE	5881	(*)				(*)
W650	99' - 06'	BAT	8088	(*)				(*)
W650	99' - 06'	TOURING II	5267	(*)				(*)
W650	99' - 06'	UP&DOWN	2193	(*)				(*)
W800	11' - 16'	STREAM	5022	(*)				(*)
W800	11' - 16'	STREAM WITH VISOR	5920H	(*)				
W800	11' - 16'	RAFALE	5881	(*)				(*)

MODEL	YEAR	TYPE OF WINDSHIELD	REF.	H	
W800	11' - 16'	BAT	8088	(*)	(*)
W800	11' - 16'	TOURING II	5267	(*)	(*)
W800	11' - 16'	UP&DOWN	2193	(*)	(*)
Z125	17' - 18'	STREAM	5022	(*)	(*)
Z125	17' - 18'	STREAM WITH VISOR	5920H	(*)	
Z125	17' - 18'	RAFALE	5881	(*)	(*)
Z125	17' - 18'	BAT	8088	(*)	(*)
Z125	17' - 18'	UP&DOWN	2193	(*)	(*)
Z250SL	15' - 16'	STREAM	5022	(*)	(*)
Z250SL	15' - 16'	STREAM WITH VISOR	5920H	(*)	
Z250SL	15' - 16'	RAFALE	5881	(*)	(*)
Z250SL	15' - 16'	BAT	8088	(*)	(*)
Z250SL	15' - 16'	TOURING II	5267	(*)	(*)
Z250SL	15' - 16'	UP&DOWN	2193	(*)	(*)
Z300	15' - 17'	STREAM	5022	(*)	(*)
Z300	15' - 17'	STREAM WITH VISOR	5920H	(*)	
Z300	15' - 17'	RAFALE	5881	(*)	(*)
Z300	15' - 17'	BAT	8088	(*)	(*)
Z300	15' - 17'	TOURING II	5267	(*)	(*)
Z300	15' - 17'	UP&DOWN	2193	(*)	(*)
Z650	17' - 18'	STREAM	6407	(*)	(*)
Z650	17' - 18'	STREAM WITH VISOR	6408H	(*)	
Z650	17' - 18'	RAFALE	6409	(*)	(*)
Z650	17' - 18'	BAT	9987	(*)	(*)
Z650	17' - 18'	TOURING II	6410	(*)	(*)
Z650	17' - 18'	UP&DOWN	1948	(*)	(*)
Z750	07' - 12'	STREAM	5022	(*)	(*)
Z750	07' - 12'	STREAM WITH VISOR	5920H	(*)	
Z750	07' - 12'	RAFALE	5881	(*)	(*)
Z750	07' - 12'	BAT	8088	(*)	(*)
Z750	07' - 12'	TOURING II	5267	(*)	(*)
Z750	07' - 12'	UP&DOWN	2193	(*)	(*)
Z750R	11' - 12'	STREAM	5022	(*)	(*)
Z750R	11' - 12'	STREAM WITH VISOR	5920H	(*)	
Z750R	11' - 12'	RAFALE	5881	(*)	(*)

 COLORS: BAT
 COLORS: RAFALE
 COLORS: STREAM
 COLORS: STREAM WITH VISOR
 COLORS: UP&DOWN
 COLORS: TOURING II

(*) Check price with your distributor.

IMPORTANT: Indicate code color after part#. Example: 0973A.



BAT



RAFALE



STREAM

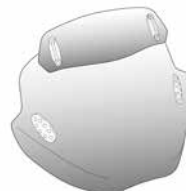

STREAM WITH VISOR









UP&DOWN



TOURING II

MODEL	YEAR	TYPE OF WINDSHIELD	REF.	H	R A	T N	G W	V F
Z750R	11' - 12'	BAT	8088	(*)				(*)
Z750R	11' - 12'	TOURING II	5267	(*)				(*)
Z750R	11' - 12'	UP&DOWN	2193	(*)				(*)
Z800/E	13' - 16'	STREAM	5022	(*)				(*)
Z800/E	13' - 16'	STREAM WITH VISOR	5920H	(*)				
Z800/E	13' - 16'	RAFALE	5881	(*)				(*)
Z800/E	13' - 16'	BAT	8088	(*)				(*)
Z800/E	13' - 16'	TOURING II	5267	(*)				(*)
Z800/E	13' - 16'	UP&DOWN	2193	(*)				(*)
Z900	17' - 18'	STREAM	6407	(*)				(*)
Z900	17' - 18'	STREAM WITH VISOR	6408H	(*)				
Z900	17' - 18'	RAFALE	6409	(*)				(*)
Z900	17' - 18'	BAT	9987	(*)				(*)
Z900	17' - 18'	TOURING II	6410	(*)				(*)
Z900	17' - 18'	UP&DOWN	1948	(*)				(*)
Z900RS	18'	STREAM	5022	(*)				(*)
Z900RS	18'	STREAM WITH VISOR	5920H	(*)				
Z900RS	18'	BAT	8088	(*)				(*)
Z900RS	18'	TOURING II	5267	(*)				(*)
Z900RS	18'	UP&DOWN	2193	(*)				(*)
Z1000	10' - 13'	STREAM	5022	(*)				(*)
Z1000	10' - 13'	STREAM WITH VISOR	5920H	(*)				
Z1000	10' - 13'	RAFALE	5881	(*)				(*)
Z1000	10' - 13'	BAT	8088	(*)				(*)
Z1000	10' - 13'	TOURING II	5267	(*)				(*)
Z1000	10' - 13'	UP&DOWN	2193	(*)				(*)
Z1000	14' - 18'	BAT	9987	(*)				(*)
Z1000	14' - 18'	TOURING II	6410	(*)				(*)
Z1000R	17' - 18'	RAFALE	6409	(*)				(*)
Z1000R	17' - 18'	BAT	9987	(*)				(*)
Z1000R	17' - 18'	TOURING II	6410	(*)				(*)
Z1000R	17' - 18'	UP&DOWN	1948	(*)				(*)

MODEL	YEAR	TYPE OF WINDSHIELD	REF.	H	
ZEPHYR 1100	92' - 97'	STREAM	5022	(*)	(*)
ZEPHYR 1100	92' - 97'	STREAM WITH VISOR	5920H	(*)	
ZEPHYR 1100	92' - 97'	RAFALE	5881	(*)	(*)
ZEPHYR 1100	92' - 97'	BAT	8088	(*)	(*)
ZEPHYR 1100	92' - 97'	TOURING II	5267	(*)	(*)
ZEPHYR 1100	92' - 97'	UP&DOWN	2193	(*)	(*)
ZR7	99' - 03'	STREAM	5022	(*)	(*)
ZR7	99' - 03'	STREAM WITH VISOR	5920H	(*)	
ZR7	99' - 03'	RAFALE	5881	(*)	(*)
ZR7	99' - 03'	BAT	8088	(*)	(*)
ZR7	99' - 03'	TOURING II	5267	(*)	(*)
ZR7	99' - 03'	UP&DOWN	2193	(*)	(*)
KTM					
690 DUKE	12' - 18'	STREAM	5022	(*)	(*)
690 DUKE	12' - 18'	STREAM WITH VISOR	5920H	(*)	
690 DUKE	12' - 18'	RAFALE	5881	(*)	(*)
690 DUKE	12' - 18'	BAT	8088	(*)	(*)
690 DUKE	12' - 18'	TOURING II	5267	(*)	(*)
690 DUKE	12' - 18'	UP&DOWN	2193	(*)	(*)
690 DUKE R	12' - 17'	STREAM	5022	(*)	(*)
690 DUKE R	12' - 17'	STREAM WITH VISOR	5920H	(*)	
690 DUKE R	12' - 17'	RAFALE	5881	(*)	(*)
690 DUKE R	12' - 17'	BAT	8088	(*)	(*)
690 DUKE R	12' - 17'	TOURING II	5267	(*)	(*)
690 DUKE R	12' - 17'	UP&DOWN	2193	(*)	(*)
790 DUKE	18'	STREAM	5022	(*)	(*)
790 DUKE	18'	STREAM WITH VISOR	5920H	(*)	
790 DUKE	18'	RAFALE	5881	(*)	(*)
790 DUKE	18'	BAT	8088	(*)	(*)
790 DUKE	18'	TOURING II	5267	(*)	(*)
790 DUKE	18'	UP&DOWN	2193	(*)	(*)
KYMCO					
CK1 125	15' - 18'	STREAM	5022	(*)	(*)
CK1 125	15' - 18'	STREAM WITH VISOR	5920H	(*)	
CK1 125	15' - 18'	RAFALE	5881	(*)	(*)

 COLORS: BAT
 COLORS: RAFALE
 COLORS: STREAM
 COLORS: STREAM WITH VISOR
 COLORS: UP&DOWN
 COLORS: TOURING II

(*) Check price with your distributor.

IMPORTANT: Indicate code color after part#. Example: 0973A.



BAT



RAFALE



STREAM

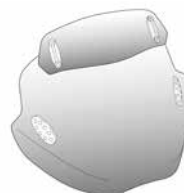

STREAM WITH VISOR

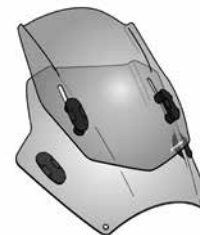







UP&DOWN



TOURING II

MODEL	YEAR	TYPE OF WINDSHIELD	REF.	H	R A	T N	G W	V F
CK1 125	15' - 18'	BAT	8088	(*)				(*)
CK1 125	15' - 18'	TOURING II	5267	(*)				(*)
CK1 125	15' - 18'	UP&DOWN	2193	(*)				(*)
K-PIPE 125	13' - 18'	STREAM	5022	(*)				(*)
K-PIPE 125	13' - 18'	STREAM WITH VISOR	5920H	(*)				
K-PIPE 125	13' - 18'	RAFALE	5881	(*)				(*)
K-PIPE 125	13' - 18'	BAT	8088	(*)				(*)
K-PIPE 125	13' - 18'	TOURING II	5267	(*)				(*)
K-PIPE 125	13' - 18'	UP&DOWN	2193	(*)				(*)
QUANNON NAKED 125	07' - 18'	STREAM	5022	(*)				(*)
QUANNON NAKED 125	07' - 18'	STREAM WITH VISOR	5920H	(*)				
QUANNON NAKED 125	07' - 18'	RAFALE	5881	(*)				(*)
QUANNON NAKED 125	07' - 18'	BAT	8088	(*)				(*)
QUANNON NAKED 125	07' - 18'	TOURING II	5267	(*)				(*)
QUANNON NAKED 125	07' - 18'	UP&DOWN	2193	(*)				(*)
MV AGUSTA								
BRUTALE 675	12' - 18'	STREAM	5022	(*)				(*)
BRUTALE 675	12' - 18'	STREAM WITH VISOR	5920H	(*)				
BRUTALE 675	12' - 18'	RAFALE	5881	(*)				(*)
BRUTALE 675	12' - 18'	BAT	8088	(*)				(*)
BRUTALE 675	12' - 18'	TOURING II	5267	(*)				(*)
BRUTALE 675	12' - 18'	UP&DOWN	2193	(*)				(*)
BRUTALE 800/RR	13' - 18'	STREAM	5022	(*)				(*)
BRUTALE 800/RR	13' - 18'	STREAM WITH VISOR	5920H	(*)				
BRUTALE 800/RR	13' - 18'	RAFALE	5881	(*)				(*)
BRUTALE 800/RR	13' - 18'	BAT	8088	(*)				(*)
BRUTALE 800/RR	13' - 18'	TOURING II	5267	(*)				(*)
BRUTALE 800/RR	13' - 18'	UP&DOWN	2193	(*)				(*)
BRUTALE 920	12'	STREAM	5022	(*)				(*)
BRUTALE 920	12'	STREAM WITH VISOR	5920H	(*)				
BRUTALE 920	12'	RAFALE	5881	(*)				(*)
BRUTALE 920	12'	BAT	8088	(*)				(*)

MODEL	YEAR	TYPE OF WINDSHIELD	REF.	H	
BRUTALE 920	12'	TOURING II	5267	(*)	(*)
BRUTALE 920	12'	UP&DOWN	2193	(*)	(*)
BRUTALE 1090 RR	10' - 18'	STREAM	5022	(*)	(*)
BRUTALE 1090 RR	10' - 18'	STREAM WITH VISOR	5920H	(*)	
BRUTALE 1090 RR	10' - 18'	RAFALE	5881	(*)	(*)
BRUTALE 1090 RR	10' - 18'	BAT	8088	(*)	(*)
BRUTALE 1090 RR	10' - 18'	TOURING II	5267	(*)	(*)
BRUTALE 1090 RR	10' - 18'	UP&DOWN	2193	(*)	(*)
SUZUKI					
B-KING	08' - 11'	STREAM	5022	(*)	(*)
B-KING	08' - 11'	STREAM WITH VISOR	5920H	(*)	
B-KING	08' - 11'	RAFALE	5881	(*)	(*)
B-KING	08' - 11'	BAT	8088	(*)	(*)
B-KING	08' - 11'	TOURING II	5267	(*)	(*)
B-KING	08' - 11'	UP&DOWN	2193	(*)	(*)
GS500E	01' - 04'	STREAM	5022	(*)	(*)
GS500E	01' - 04'	STREAM WITH VISOR	5920H	(*)	
GS500E	01' - 04'	RAFALE	5881	(*)	(*)
GS500E	01' - 04'	BAT	8088	(*)	(*)
GS500E	01' - 04'	TOURING II	5267	(*)	(*)
GS500E	01' - 04'	UP&DOWN	2193	(*)	(*)
GSF600 BANDIT	96' - 04'	STREAM	5022	(*)	(*)
GSF600 BANDIT	96' - 04'	STREAM WITH VISOR	5920H	(*)	
GSF600 BANDIT	96' - 04'	RAFALE	5881	(*)	(*)
GSF600 BANDIT	96' - 04'	BAT	8088	(*)	(*)
GSF600 BANDIT	96' - 04'	TOURING II	5267	(*)	(*)
GSF600 BANDIT	96' - 04'	UP&DOWN	2193	(*)	(*)
GSF650 BANDIT	05' - 11'	STREAM	5022	(*)	(*)
GSF650 BANDIT	05' - 11'	STREAM WITH VISOR	5920H	(*)	
GSF650 BANDIT	05' - 11'	RAFALE	5881	(*)	(*)
GSF650 BANDIT	05' - 11'	BAT	8088	(*)	(*)
GSF650 BANDIT	05' - 11'	TOURING II	5267	(*)	(*)
GSF650 BANDIT	05' - 11'	UP&DOWN	2193	(*)	(*)
GSF1200 BANDIT	96' - 06'	STREAM	5022	(*)	(*)
GSF1200 BANDIT	96' - 06'	STREAM WITH VISOR	5920H	(*)	

 COLORS: BAT
 COLORS: RAFALE
 COLORS: STREAM
 COLORS: STREAM WITH VISOR
 COLORS: UP&DOWN
 COLORS: TOURING II

(*) Check price with your distributor.

IMPORTANT: Indicate code color after part#. Example: 0973A.



BAT



RAFALE



STREAM

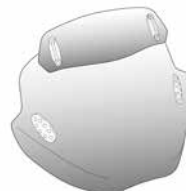

STREAM WITH VISOR









UP&DOWN

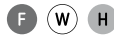

TOURING II

MODEL	YEAR	TYPE OF WINDSHIELD	REF.	H	R A	T N	G W	V F
GSF1200 BANDIT	96' - 06'	RAFALE	5881	(*)				(*)
GSF1200 BANDIT	96' - 06'	BAT	8088	(*)				(*)
GSF1200 BANDIT	96' - 06'	TOURING II	5267	(*)				(*)
GSF1200 BANDIT	96' - 06'	UP&DOWN	2193	(*)				(*)
GSF1250 BANDIT	07' - 13'	STREAM	5022	(*)				(*)
GSF1250 BANDIT	07' - 13'	STREAM WITH VISOR	5920H	(*)				
GSF1250 BANDIT	07' - 13'	RAFALE	5881	(*)				(*)
GSF1250 BANDIT	07' - 13'	BAT	8088	(*)				(*)
GSF1250 BANDIT	07' - 13'	TOURING II	5267	(*)				(*)
GSF1250 BANDIT	07' - 13'	UP&DOWN	2193	(*)				(*)
GSR600	06' - 11'	STREAM	5022	(*)				(*)
GSR600	06' - 11'	STREAM WITH VISOR	5920H	(*)				
GSR600	06' - 11'	RAFALE	5881	(*)				(*)
GSR600	06' - 11'	BAT	8088	(*)				(*)
GSR600	06' - 11'	TOURING II	5267	(*)				(*)
GSR600	06' - 11'	UP&DOWN	2193	(*)				(*)
GSR750	11' - 16'	STREAM	5022	(*)				(*)
GSR750	11' - 16'	STREAM WITH VISOR	5920H	(*)				
GSR750	11' - 16'	RAFALE	5881	(*)				(*)
GSR750	11' - 16'	BAT	8088	(*)				(*)
GSR750	11' - 16'	TOURING II	5267	(*)				(*)
GSR750	11' - 16'	UP&DOWN	2193	(*)				(*)
GSX-S125	17' - 18'	STREAM	5022	(*)				(*)
GSX-S125	17' - 18'	STREAM WITH VISOR	5920H	(*)				
GSX-S125	17' - 18'	RAFALE	5881	(*)				(*)
GSX-S125	17' - 18'	BAT	8088	(*)				(*)
GSX-S125	17' - 18'	TOURING II	5267	(*)				(*)
GSX-S125	17' - 18'	UP&DOWN	2193	(*)				(*)
GSX-S750	17' - 18'	STREAM	5022	(*)				(*)
GSX-S750	17' - 18'	STREAM WITH VISOR	5920H	(*)				
GSX-S750	17' - 18'	RAFALE	5881	(*)				(*)
GSX-S750	17' - 18'	BAT	8088	(*)				(*)

MODEL	YEAR	TYPE OF WINDSHIELD	REF.	H	
GSX-S750	17' - 18'	TOURING II	5267	(*)	(*)
GSX-S750	17' - 18'	UP&DOWN	2193	(*)	(*)
GSX-S1000	15' - 18'	STREAM	5022	(*)	(*)
GSX-S1000	15' - 18'	STREAM WITH VISOR	5920H	(*)	
GSX-S1000	15' - 18'	RAFALE	5881	(*)	(*)
GSX-S1000	15' - 18'	BAT	8088	(*)	(*)
GSX-S1000	15' - 18'	TOURING II	5267	(*)	(*)
GSX-S1000	15' - 18'	UP&DOWN	2193	(*)	(*)
INAZUMA	13' - 17'	STREAM	6856	(*)	(*)
INAZUMA	13' - 17'	STREAM WITH VISOR	6858H	(*)	
INAZUMA	13' - 17'	RAFALE	6860	(*)	(*)
INAZUMA	13' - 17'	BAT	9988	(*)	(*)
INAZUMA	13' - 17'	TOURING II	6862	(*)	(*)
INAZUMA	13' - 17'	UP&DOWN	1949	(*)	(*)
SFV650 GLADIUS	09' - 15'	STREAM	5022	(*)	(*)
SFV650 GLADIUS	09' - 15'	STREAM WITH VISOR	5920H	(*)	
SFV650 GLADIUS	09' - 15'	RAFALE	5881	(*)	(*)
SFV650 GLADIUS	09' - 15'	BAT	8088	(*)	(*)
SFV650 GLADIUS	09' - 15'	TOURING II	5267	(*)	(*)
SFV650 GLADIUS	09' - 15'	UP&DOWN	2193	(*)	(*)
SV650	03' - 06'	STREAM	5022	(*)	(*)
SV650	03' - 06'	STREAM WITH VISOR	5920H	(*)	
SV650	03' - 06'	RAFALE	5881	(*)	(*)
SV650	03' - 06'	BAT	8088	(*)	(*)
SV650	03' - 06'	TOURING II	5267	(*)	(*)
SV650	03' - 06'	UP&DOWN	2193	(*)	(*)
SV650	16' - 18'	STREAM	5022	(*)	(*)
SV650	16' - 18'	STREAM WITH VISOR	5920H	(*)	
SV650	16' - 18'	RAFALE	5881	(*)	(*)
SV650	16' - 18'	BAT	8088	(*)	(*)
SV650	16' - 18'	TOURING II	5267	(*)	(*)
SV650	16' - 18'	UP&DOWN	2193	(*)	(*)
SV1000	03' - 05'	STREAM	5022	(*)	(*)
SV1000	03' - 05'	STREAM WITH VISOR	5920H	(*)	
SV1000	03' - 05'	RAFALE	5881	(*)	(*)

 COLORS: BAT
 COLORS: RAFALE
 COLORS: STREAM
 COLORS: STREAM WITH VISOR
 COLORS: UP&DOWN
 COLORS: TOURING II

(*) Check price with your distributor.

IMPORTANT: Indicate code color after part#. Example: 0973A.



BAT



RAFALE



STREAM

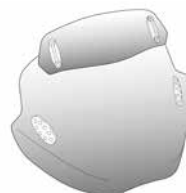

STREAM WITH VISOR









UP&DOWN



TOURING II

MODEL	YEAR	TYPE OF WINDSHIELD	REF.	H	R A	T N	G W	V F
SV1000	03' - 05'	BAT	8088	(*)				(*)
SV1000	03' - 05'	TOURING II	5267	(*)				(*)
SV1000	03' - 05'	UP&DOWN	2193	(*)				(*)
TRIUMPH								
BONNEVILLE BOBBER	17' - 18'	STREAM	5022	(*)				(*)
BONNEVILLE BOBBER	17' - 18'	STREAM WITH VISOR	5920H	(*)				
BONNEVILLE BOBBER	17' - 18'	BAT	8088	(*)				(*)
BONNEVILLE BOBBER	17' - 18'	TOURING II	5267	(*)				(*)
BONNEVILLE BOBBER	17' - 18'	UP&DOWN	2193	(*)				(*)
BONNEVILLE SPEEDMASTER	18'	STREAM	5022	(*)				(*)
BONNEVILLE SPEEDMASTER	18'	STREAM WITH VISOR	5920H	(*)				
BONNEVILLE SPEEDMASTER	18'	BAT	8088	(*)				(*)
BONNEVILLE SPEEDMASTER	18'	TOURING II	5267	(*)				(*)
BONNEVILLE SPEEDMASTER	18'	UP&DOWN	2193	(*)				(*)
BONNEVILLE T120/T100	16' - 18'	STREAM	5022	(*)				(*)
BONNEVILLE T120/T100	16' - 18'	STREAM WITH VISOR	5920H	(*)				
BONNEVILLE T120/T100	16' - 18'	BAT	8088	(*)				(*)
BONNEVILLE T120/T100	16' - 18'	TOURING II	5267	(*)				(*)
BONNEVILLE T120/T100	16' - 18'	UP&DOWN	2193	(*)				(*)
SPEED TRIPLE/R	16' -18'	STREAM	5022	(*)				(*)
SPEED TRIPLE/R	16' -18'	STREAM WITH VISOR	5920H	(*)				
SPEED TRIPLE/R	16' -18'	RAFALE	5881	(*)				(*)
SPEED TRIPLE/R	16' -18'	BAT	8088	(*)				(*)
SPEED TRIPLE/R	16' -18'	TOURING II	5267	(*)				(*)
SPEED TRIPLE/R	16' -18'	UP&DOWN	2193	(*)				(*)
STREET SCRAMBLER	17' -18'	STREAM	5022	(*)				(*)
STREET SCRAMBLER	17' -18'	STREAM WITH VISOR	5920H	(*)				
STREET SCRAMBLER	17' - 18'	BAT	8088	(*)				(*)
STREET SCRAMBLER	17' -18'	TOURING II	5267	(*)				(*)
STREET SCRAMBLER	17' -18'	UP&DOWN	2193	(*)				(*)
STREET TWIN	16' - 18'	STREAM	5022	(*)				(*)
STREET TWIN	16' - 18'	STREAM WITH VISOR	5920H	(*)				







MODEL	YEAR	TYPE OF WINDSHIELD	REF.	H	
STREET TWIN	16' - 18'	BAT	8088	(*)	(*)
STREET TWIN	16' - 18'	TOURING II	5267	(*)	(*)
STREET TWIN	16' - 18'	UP&DOWN	2193	(*)	(*)
YAMAHA					
FZ1	06' - 15'	STREAM	5022	(*)	(*)
FZ1	06' - 15'	STREAM WITH VISOR	5920H	(*)	
FZ1	06' - 15'	RAFALE	5881	(*)	(*)
FZ1	06' - 15'	BAT	8088	(*)	(*)
FZ1	06' - 15'	TOURING II	5267	(*)	(*)
FZ1	06' - 15'	UP&DOWN	2193	(*)	(*)
FZ8	10' - 16'	STREAM	5022	(*)	(*)
FZ8	10' - 16'	STREAM WITH VISOR	5920H	(*)	
FZ8	10' - 16'	RAFALE	5881	(*)	(*)
FZ8	10' - 16'	BAT	8088	(*)	(*)
FZ8	10' - 16'	TOURING II	5267	(*)	(*)
FZ8	10' - 16'	UP&DOWN	2193	(*)	(*)
MT-01	05' - 13'	STREAM	5022	(*)	(*)
MT-01	05' - 13'	STREAM WITH VISOR	5920H	(*)	
MT-01	05' - 13'	RAFALE	5881	(*)	(*)
MT-01	05' - 13'	BAT	8088	(*)	(*)
MT-01	05' - 13'	TOURING II	5267	(*)	(*)
MT-01	05' - 13'	UP&DOWN	2193	(*)	(*)
MT-03	06' - 14'	STREAM	5022	(*)	(*)
MT-03	06' - 14'	STREAM WITH VISOR	5920H	(*)	
MT-03	06' - 14'	RAFALE	5881	(*)	(*)
MT-03	06' - 14'	BAT	8088	(*)	(*)
MT-03	06' - 14'	TOURING II	5267	(*)	(*)
MT-03	06' - 14'	UP&DOWN	2193	(*)	(*)
MT-03	16' - 18'	STREAM	5022	(*)	(*)
MT-03	16' - 18'	STREAM WITH VISOR	5920H	(*)	
MT-03	16' - 18'	RAFALE	5881	(*)	(*)
MT-03	16' - 18'	BAT	8088	(*)	(*)
MT-03	16' - 18'	TOURING II	5267	(*)	(*)
MT-03	16' - 18'	UP&DOWN	2193	(*)	(*)
MT-07	14' - 18'	STREAM	6892	(*)	(*)

 COLORS: BAT
 COLORS: RAFALE
 COLORS: STREAM
 COLORS: STREAM WITH VISOR
 COLORS: UP&DOWN
 COLORS: TOURING II

(*) Check price with your distributor.

IMPORTANT: Indicate code color after part#. Example: 0973A.

MODEL	YEAR	TYPE OF WINDSHIELD	REF.	H	
XJ6	09' - 16'	RAFALE	5881	(*)	(*)
XJ6	09' - 16'	BAT	8088	(*)	(*)
XJ6	09' - 16'	TOURING II	5267	(*)	(*)
XJ6	09' - 16'	UP&DOWN	2193	(*)	(*)
XJR1200	94' - 98'	STREAM	5022	(*)	(*)
XJR1200	94' - 98'	STREAM WITH VISOR	5920H	(*)	
XJR1200	94' - 98'	RAFALE	5881	(*)	(*)
XJR1200	94' - 98'	BAT	8088	(*)	(*)
XJR1200	94' - 98'	TOURING II	5267	(*)	(*)
XJR1200	94' - 98'	UP&DOWN	2193	(*)	(*)
XJR1300	99' - 13'	STREAM	5022	(*)	(*)
XJR1300	99' - 13'	STREAM WITH VISOR	5920H	(*)	
XJR1300	99' - 13'	RAFALE	5881	(*)	(*)
XJR1300	99' - 13'	BAT	8088	(*)	(*)
XJR1300	99' - 13'	TOURING II	5267	(*)	(*)
XJR1300	99' - 13'	UP&DOWN	2193	(*)	(*)
XSR700	16' - 18'	STREAM	5022	(*)	(*)
XSR700	16' - 18'	STREAM WITH VISOR	5920H	(*)	
XSR700	16' - 18'	BAT	8088	(*)	(*)
XSR700	16' - 18'	TOURING II	5267	(*)	(*)
XSR700	16' - 18'	UP&DOWN	2193	(*)	(*)
XSR900	16' - 18'	STREAM	5022	(*)	(*)
XSR900	16' - 18'	STREAM WITH VISOR	5920H	(*)	
XSR900	16' - 18'	BAT	8088	(*)	(*)
XSR900	16' - 18'	TOURING II	5267	(*)	(*)
XSR900	16' - 18'	UP&DOWN	2193	(*)	(*)

 COLORS: BAT
 COLORS: RAFALE
 COLORS: STREAM
 COLORS: STREAM WITH VISOR
 COLORS: UP&DOWN
 COLORS: TOURING II

(*) Check price with your distributor.

IMPORTANT: Indicate code color after part#. Example: 0973A.





// AERODYNAMIC TEST



2 FIXATION POINTS



2 FIXATION POINTS



J
Matt Black

C
Carbon Look



BMW R NINE T (REF. 9160F)

MODEL	REF.	F	H	W	N
UNIVERSAL BLACK SEMI-FAIRING Ø 195 mm.	9553				(*)
UNIVERSAL CARBON LOOK SEMI-FAIRING Ø 195 mm.	9515				(*)
UNIVERSAL BLACK SEMI-FAIRING Ø 180 mm.	9554				(*)
UNIVERSAL CARBON LOOK SEMI-FAIRING Ø 180 mm.	9516				(*)

SPARES	REF.	F	H	W	N	J	C
SEMI-FAIRINGS Ø 195 mm.	9230					(*)	(*)
SEMI-FAIRINGS Ø 180 mm.	9231					(*)	(*)
SCREEN Ø 195 mm.	9196			(*)			
SCREEN Ø 180 mm.	9872			(*)			
UNIVERSAL SUPPORTS SEMI-FAIRING Ø 195 mm.	9978N			(*)			
UNIVERSAL SUPPORTS SEMI-FAIRING Ø 180 mm.	9979N			(*)			





// AERODYNAMIC TEST

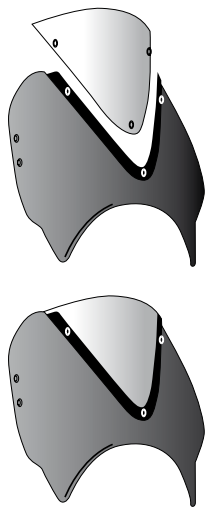
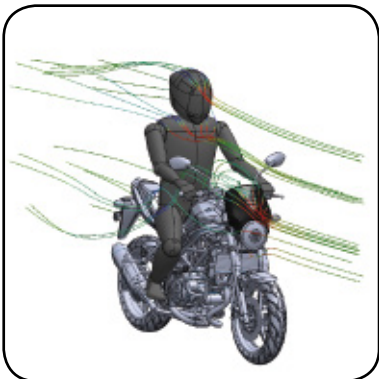

The retrovision is formed by a opaque base (black or carbon look) an a screen light smoke, dark smoke, black or clear.



J Matt Black
C Carbon Look



DUCATI SCRAMBLER (part# 7652)

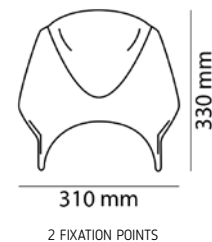

MODEL	REF.	J	F	H	W	N	C
UNIVERSAL RETROVISION (#)	SEE PAGE 335						
SPARES	REF.	J	F	H	W	N	C
SCREEN	1517						(*)

FOR SPECIFIC MODELS SEE PAGE 98
(#) ADHESIVE KIT INCLUDED



FRONTAL PLATE (IN ALUMINIUM)

HI-TECH PARTS | TECHNICAL SECTION

95

NEW!



// AERODYNAMIC TEST



May be used as small screen for wind protection or as a number plate.
Look at adhesive numbers on page 408.
It carries a set of universal supports or specific for selected models.

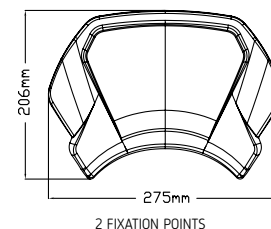

P
Aluminium

N
Black

MODEL	REF.	P	N
FRONT PLATE UNIVERSAL	9804	(*)	(*)

SPARES	REF.	P	N
ALUMINIUM FRONTAL PLATE	9807	(*)	(*)
UNIVERSAL SUPPORTS	9977		(*)

FOR SPECIFIC MODELS SEE PAGE 98

(*) Check price with your distributor.



FRONTAL PLATE (IN ABS)

HI-TECH PARTS | TECHNICAL SECTION



// AERODYNAMIC TEST



Double function: Deflects wind and number plate.
Available with universal supports or specific for selected motorcycles.

// FRONTAL PLATE

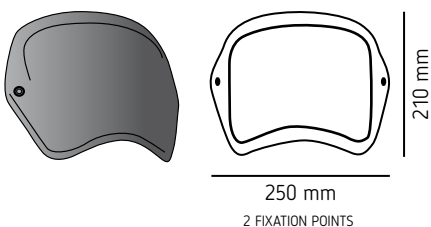

// ASYMMETRIC FRONTAL PLATE

(Only Ref. 9177, 9522)

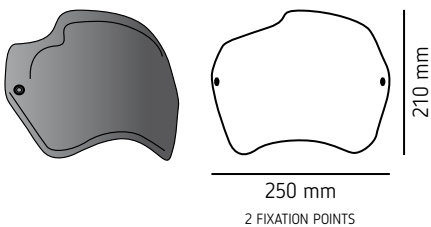

J Matt Black
C Carbon Look



MODEL	REF.	J	C	N
FRONTAL PLATE UNIVERSAL (#)	8833	(*)	(*)	

SPARES	REF.	J	C	N
FRONTAL PLATE	9229	(*)	(*)	
UNIVERSAL SUPPORTS	9977			(*)

FOR SPECIFIC MODELS SEE PAGE 98
(#) ADHESIVE KIT INCLUDED

(*) Check price with your distributor.



SEMI-FAIRING



RETROVISIONS

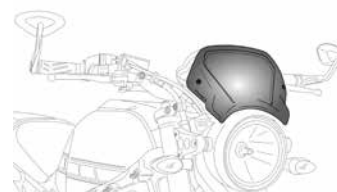

ALUMINIUM FRONTAL PLATE



ABS FRONTAL PLATE

MODEL	YEAR	TYPE	ADHESIVE KIT	COLOR	REF.	F W	H N	J	C	P
BMW										
R NINE T	14' - 18'	RETROVISION	INCLUDED	MATT BLACK	7012	(*)				
R NINE T	14' - 18'	RETROVISION	INCLUDED	CARBON LOOK	7559	(*)				
R NINE T	14' - 18'	ABS FRONTAL PLATE	INCLUDED		9167			(*)	(*)	
R NINE T	14' - 18'	ALUMINIUM FRONTAL PLATE			9798	(*)				(*)
R NINE T	14' - 18'	SEMI-FAIRING	INCLUDED	MATT BLACK	9160	(*)				
R NINE T	14' - 18'	SEMI-FAIRING	INCLUDED	CARBON LOOK	9178	(*)				
R NINE T SCRAMBLER	16' - 18'	RETROVISION	INCLUDED	MATT BLACK	9338	(*)				
R NINE T SCRAMBLER	16' - 18'	RETROVISION	INCLUDED	CARBON LOOK	9339	(*)				
R NINE T SCRAMBLER	16' - 18'	ABS FRONTAL PLATE	INCLUDED		9252			(*)	(*)	
R NINE T SCRAMBLER	16' - 18'	ALUMINIUM FRONTAL PLATE			9797	(*)				(*)
R NINE T SCRAMBLER	16' - 18'	SEMI-FAIRING	INCLUDED	MATT BLACK	9253	(*)				
R NINE T SCRAMBLER	16' - 18'	SEMI-FAIRING	INCLUDED	CARBON LOOK	9254	(*)				
R NINE T PURE	17' - 18'	RETROVISION	INCLUDED	MATT BLACK	7012	(*)				
R NINE T PURE	17' - 18'	RETROVISION	INCLUDED	CARBON LOOK	7559	(*)				
R NINE T PURE	17' - 18'	ABS FRONTAL PLATE	INCLUDED		9167			(*)	(*)	
R NINE T PURE	17' - 18'	ALUMINIUM FRONTAL PLATE			9798	(*)				(*)
DUCATI										
SCRAMBLER ICON/CLASSIC/FULL THROTTLE	15' - 18'	RETROVISION	INCLUDED	MATT BLACK	7652	(*)				
SCRAMBLER ICON/CLASSIC/FULL THROTTLE	15' - 18'	RETROVISION	INCLUDED	CARBON LOOK	8192	(*)				
SCRAMBLER ICON/CLASSIC/FULL THROTTLE	15' - 18'	ABS FRONTAL PLATE ASYMMETRIC	INCLUDED		9177			(*)	(*)	
SCRAMBLER ICON/CLASSIC/FULL THROTTLE	15' - 18'	ALUMINIUM FRONTAL PLATE			9799	(*)				(*)
SCRAMBLER SIXTY2	16' - 18'	RETROVISION	INCLUDED	MATT BLACK	7652	(*)				
SCRAMBLER SIXTY2	16' - 18'	RETROVISION	INCLUDED	CARBON LOOK	8192	(*)				
SCRAMBLER URBAN ENDURO	15' - 16'	RETROVISION	INCLUDED	MATT BLACK	7652	(*)				
SCRAMBLER URBAN ENDURO	15' - 16'	RETROVISION	INCLUDED	CARBON LOOK	8192	(*)				
SCRAMBLER URBAN ENDURO	15' - 16'	ABS FRONTAL PLATE ASYMMETRIC	INCLUDED		9177			(*)	(*)	
SCRAMBLER URBAN ENDURO	15' - 16'	ALUMINIUM FRONTAL PLATE			9799	(*)				(*)
SCRAMBLER FLAT TRACK PRO	16'	RETROVISION	INCLUDED	MATT BLACK	7652	(*)				
SCRAMBLER FLAT TRACK PRO	16'	RETROVISION	INCLUDED	CARBON LOOK	8192	(*)				

MODEL	YEAR	TYPE	ADHESIVE KIT	COLOR	REF.	F H		J	C	P
						W	N			
SCRAMBLER FLAT TRACK PRO	16'	ABS FRONTAL PLATE ASYMMETRIC	INCLUDED		9177			(*)	(*)	
SCRAMBLER FLAT TRACK PRO	16'	ALUMINIUM FRONTAL PLATE			9799	(*)				(*)
SCRAMBLER DESERT SLED/CAFE RACER	17' - 18'	RETROVISION	INCLUDED	MATT BLACK	7652	(*)				
SCRAMBLER DESERT SLED/CAFE RACER	17' - 18'	RETROVISION	INCLUDED	CARBON LOOK	8192	(*)				
SCRAMBLER DESERT SLED	17' - 18'	ABS FRONTAL PLATE ASYMMETRIC	INCLUDED		9522			(*)	(*)	
SCRAMBLER DESERT SLED	17' - 18'	ALUMINIUM FRONTAL PLATE			9800	(*)				(*)
SCRAMBLER CAFE RACER	17' - 18'	ABS FRONTAL PLATE ASYMMETRIC	INCLUDED		9177			(*)	(*)	
SCRAMBLER CAFE RACER	17' - 18'	ALUMINIUM FRONTAL PLATE			9799	(*)				(*)
SCRAMBLER 1100	18'	ABS FRONTAL PLATE ASYMMETRIC	INCLUDED		9522			(*)	(*)	
SCRAMBLER 1100	18'	ALUMINIUM FRONTAL PLATE			9800	(*)				(*)
SCRAMBLER 1100 SPORT	18'	ABS FRONTAL PLATE ASYMMETRIC	INCLUDED		9522			(*)	(*)	
SCRAMBLER 1100 SPORT	18'	ALUMINIUM FRONTAL PLATE			9800	(*)				(*)
SCRAMBLER 1100 SPECIAL	18'	ABS FRONTAL PLATE ASYMMETRIC	INCLUDED		9522			(*)	(*)	
SCRAMBLER 1100 SPECIAL	18'	ALUMINIUM FRONTAL PLATE			9800	(*)				(*)
HARLEY DAVIDSON										
SPORTSTER 883 IRON	09' - 18'	ABS FRONTAL PLATE	INCLUDED		1351			(*)	(*)	
SPORTSTER 883 IRON	09' - 18'	ALUMINIUM FRONTAL PLATE			1352	(*)				(*)
HONDA										
CB125R NEO SPORTS CAFE	18'	ABS FRONTAL PLATE	INCLUDED		9663			(*)	(*)	
CB125R NEO SPORTS CAFE	18'	ALUMINIUM FRONTAL PLATE			9802	(*)				(*)
CB300R NEO SPORTS CAFE	18'	ABS FRONTAL PLATE	INCLUDED		9663			(*)	(*)	
CB300R NEO SPORTS CAFE	18'	ALUMINIUM FRONTAL PLATE			9802	(*)				(*)
CB1000R NEO SPORTS CAFE	18'	ABS FRONTAL PLATE	INCLUDED		9768			(*)	(*)	
CB1000R NEO SPORTS CAFE	18'	ALUMINIUM FRONTAL PLATE			9803	(*)				(*)
CB1100	13' - 14'	RETROVISION	INCLUDED	MATT BLACK	7593	(*)				
CB1100	13' - 14'	RETROVISION	INCLUDED	CARBON LOOK	7594	(*)				
CB1100	13' - 14'	SEMI-FAIRING	INCLUDED	MATT BLACK	9553	(*)				
CB1100	13' - 14'	SEMI-FAIRING	INCLUDED	CARBON LOOK	9515	(*)				
CB1100 EX	14' - 18'	SEMI-FAIRING	INCLUDED	MATT BLACK	9553	(*)				
CB1100 EX	14' - 18'	SEMI-FAIRING	INCLUDED	CARBON LOOK	9515	(*)				
CB1100 RS	17' - 18'	SEMI-FAIRING	INCLUDED	MATT BLACK	9553	(*)				
CB1100 RS	17' - 18'	SEMI-FAIRING	INCLUDED	CARBON LOOK	9515	(*)				
HUSQVARNA										
VITPILEN 701	17' - 18'	ABS FRONTAL PLATE	INCLUDED		8833			(*)	(*)	
VITPILEN 701	17' - 18'	ALUMINIUM FRONTAL PLATE			9804	(*)				(*)

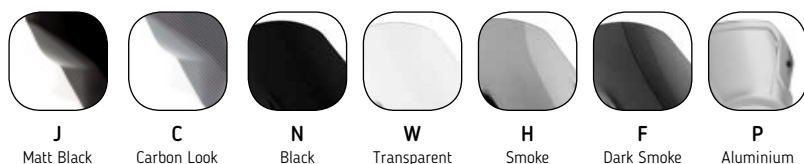

(*) Check price with your distributor.

IMPORTANT: Indicate code color after part#. Example: 0973A.

RETROVISIONS | FRONTAL PLATES | SEMI-FAIRING

HI-TECH PARTS

2019
MODELS:
www.puig.tv



SEMI-FAIRING



RETROVISIONS

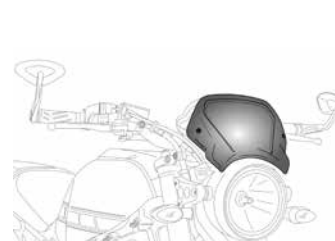

ALUMINIUM FRONTAL PLATE



ABS FRONTAL PLATE

MODEL	YEAR	TYPE	ADHESIVE KIT	COLOR	REF.	F W	H N	J	C	P
KAWASAKI										
Z900RS	18'	SEMI-FAIRING	INCLUDED	MATT BLACK	9595	(*)				
Z900RS	18'	SEMI-FAIRING	INCLUDED	CARBON LOOK	9596	(*)				
VULCAN S	15' - 18'	ABS FRONTAL PLATE	INCLUDED		8833			(*)	(*)	
VULCAN S	15' - 18'	ALUMINIUM FRONTAL PLATE			9804	(*)				(*)
VULCAN S CAFE	17' - 18'	ABS FRONTAL PLATE	INCLUDED		8833			(*)	(*)	
VULCAN S CAFE	17' - 18'	ALUMINIUM FRONTAL PLATE			9804	(*)				(*)
SUZUKI										
SV650	16' - 18'	RETROVISION	INCLUDED	MATT BLACK	8926	(*)				
SV650	16' - 18'	RETROVISION	INCLUDED	CARBON LOOK	8927	(*)				
TRIUMPH										
BONNEVILLE SPEEDMASTER	18'	ABS FRONTAL PLATE	INCLUDED		8833				(*)	
BONNEVILLE SPEEDMASTER	18'	ALUMINIUM FRONTAL PLATE			9804	(*)				(*)
BONNEVILLE SPEEDMASTER	18'	SEMI-FAIRING	INCLUDED	MATT BLACK	9554					
BONNEVILLE SPEEDMASTER	18'	SEMI-FAIRING	INCLUDED	CARBON LOOK	9516					
BONNEVILLE T100/T120	16' - 18'	ABS FRONTAL PLATE	INCLUDED		9191			(*)	(*)	
BONNEVILLE T100/T120	16' - 18'	ALUMINIUM FRONTAL PLATE			9808	(*)				(*)
BONNEVILLE T100/T120	16' - 18'	SEMI-FAIRING	INCLUDED	MATT BLACK	9176	(*)				
BONNEVILLE T100/T120	16' - 18'	SEMI-FAIRING	INCLUDED	CARBON LOOK	9195	(*)				
STREET TWIN	16' - 18'	SEMI-FAIRING	INCLUDED	MATT BLACK	9553	(*)				
STREET TWIN	16' - 18'	SEMI-FAIRING	INCLUDED	CARBON LOOK	9515	(*)				
THRUXTON 1200/R	16' - 18'	SEMI-FAIRING	INCLUDED	MATT BLACK	9553	(*)				
THRUXTON 1200/R	16' - 18'	SEMI-FAIRING	INCLUDED	CARBON LOOK	9515	(*)				
STREET CUP	17' - 18'	SEMI-FAIRING	INCLUDED	MATT BLACK					CHECK WEB	
STREET CUP	17' - 18'	SEMI-FAIRING	INCLUDED	CARBON LOOK					CHECK WEB	
STREET SCRAMBLER	17' - 18'	SEMI-FAIRING	INCLUDED	MATT BLACK					CHECK WEB	
STREET SCRAMBLER	17' - 18'	SEMI-FAIRING	INCLUDED	CARBON LOOK					CHECK WEB	
YAMAHA										
SCR950	17' - 18'	ABS FRONTAL PLATE	INCLUDED		8833			(*)	(*)	
SCR950	17' - 18'	ALUMINIUM FRONTAL PLATE			9804					

MODEL	YEAR	TYPE	ADHESIVE KIT	COLOR	REF.	F W	H N	J	C	P
XSR700	16' - 18'	RETROVISION	INCLUDED	MATT BLACK	9560	(*)				
XSR700	16' - 18'	RETROVISION	INCLUDED	CARBON LOOK	9561	(*)				
XSR700	16' - 18'	SEMI-FAIRING	INCLUDED	MATT BLACK	8933	(*)				
XSR700	16' - 18'	SEMI-FAIRING	INCLUDED	CARBON LOOK	9187	(*)				
XSR700	16' - 18'	ABS FRONTAL PLATE	INCLUDED		8801			(*)	(*)	
XSR700	16' - 18'	ALUMINIUM FRONTAL PLATE			9805	(*)				(*)
XSR900	16' - 18'	RETROVISION	INCLUDED	MATT BLACK	9560	(*)				
XSR900	16' - 18'	RETROVISION	INCLUDED	CARBON LOOK	9561	(*)				
XSR900	16' - 18'	SEMI-FAIRING	INCLUDED	MATT BLACK	8934	(*)				
XSR900	16' - 18'	SEMI-FAIRING	INCLUDED	CARBON LOOK	9188	(*)				
XSR900	16' - 18'	ABS FRONTAL PLATE	INCLUDED		9168			(*)	(*)	
XSR900	16' - 18'	ALUMINIUM FRONTAL PLATE			9806	(*)				(*)

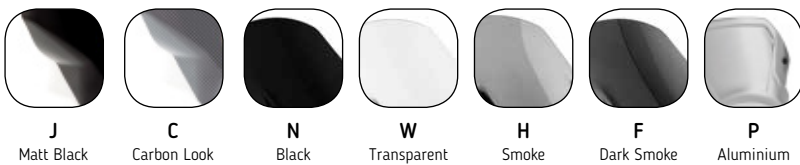

(*) Check price with your distributor.

IMPORTANT: Indicate code color after part#. Example: 0973A.



// SCREEN TESTED IN THE VIRTUAL WIND TUNNEL

The V-Tech design has been developed through our Virtual Wind Tunnel to improve stability and OEM aerodynamic penetration.

Its angulated shapes on its central and side sections esase the wind canalization redirecting it to both sides of the rider, minimizing turbulances and keeping the radical look of the pieces.



PUIG



OEM

Improved aerodynamics and wind protection
on average +24%.
Part# 6790



PUIG

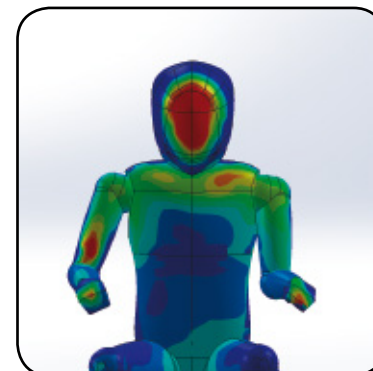

OEM

Wind pressure comparison between V-Tech Line
Puig and OEM.



SUZUKI BURGMAN 400

V-TECH LINE TOURING

www.puig.tv info@puig.tv
www.puigusa.com info@puigusa.com

REF 9973

9973F +220 mm/+8,66 in

9973H +220 mm/+8,66 in

OEM



WINDSHIELDS FOR MAXISCOOTERS

HI-TECH PARTS | TYPE OF WINDSHIELD:

2019
MODELS:
www.puig.tv

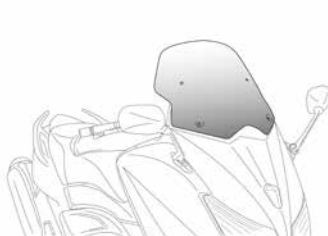

V-TECH LINE SPORT



V-TECH LINE TOURING

MODEL	YEAR	TYPE OF V-TECH LINE	REF.	DIMENSIONS (Height x Width)	HEIGHT (MM) Compared to OEM	
APRILIA						
SRV850	12' - 16'	V-TECH LINE TOURING	6030	700 x 350	+150	(*)
BMW						
C600 SPORT	12' - 15'	V-TECH LINE SPORT	6031	600 x 410	-50	(*)
C600 SPORT	12' - 15'	V-TECH LINE TOURING	6785	715 x 465	+70	(*)
C650 SPORT	16' - 18'	V-TECH LINE SPORT	9014	580 x 415	-70	(*)
C650 SPORT	16' - 18'	V-TECH LINE TOURING	9015	700 x 470	+110	(*)
C EVOLUTION	15' - 18'	V-TECH LINE TOURING	1769			(*)
HONDA						
FORZA 125	15' - 17'	V-TECH LINE TOURING	7662	590 x 410	+115	(*)
FORZA 125	18'	V-TECH LINE TOURING	1295			(*)
FORZA 300	13' - 16'	V-TECH LINE TOURING	6554	735 x 520	+250	(*)
FORZA 300	18'	V-TECH LINE TOURING	1295			(*)
INTEGRA	12' - 13'	V-TECH LINE SPORT	6283	510 x 370	-90	(*)
INTEGRA	12' - 13'	V-TECH LINE TOURING	6035	645 x 445	+60	(*)
INTEGRA 750	14' - 18'	V-TECH LINE SPORT	6283	510 x 370	-90	(*)
INTEGRA 750	14' - 18'	V-TECH LINE TOURING	6035	645 x 445	+60	(*)
PCX 125	10' - 13'	V-TECH LINE TOURING	5569	530 x 360	+140	(*)
PCX 125	14' - 17'	V-TECH LINE TOURING	7549	700 x 500	+260	(*)
PCX 125	18'	V-TECH LINE TOURING	9789			(*)
PCX ELECTRIC	18'	V-TECH LINE TOURING	9789			(*)
KAWASAKI						
J125	16' - 18'	V-TECH LINE TOURING	7020	740 x 575	+185	(*)
J300	14' - 18'	V-TECH LINE TOURING	7020	740 x 575	+185	(*)
KEEWAY						
CITYBLADE 125	13' - 18'	V-TECH LINE TOURING	8167	615 x 350	+275	(*)
KYMCO						
AK550	17' - 18'	V-TECH LINE SPORT	9478	555 x 395	+60	(*)
AK550	17' - 18'	V-TECH LINE TOURING	9477	800 x 645	-185	(*)
DINK 50	07' - 15'	V-TECH LINE TOURING	4539	490 x 440	+100	(*)
DINK 125	07' - 15'	V-TECH LINE TOURING	4539	490 x 440	+100	(*)
DINK 250	07' - 15'	V-TECH LINE TOURING	4539	490 x 440	+100	(*)

MODEL	YEAR	TYPE OF V-TECH LINE	REF.	DIMENSIONS (Height x Width)	HEIGHT (MM) Compared to OEM	N W H F
DOWNTOWN 125i	09' - 14'	V-TECH LINE SPORT	5522	540 x 460	-120	(*)
DOWNTOWN 125i	09' - 14'	V-TECH LINE TOURING	6790	750 x 615	+130	(*)
DOWNTOWN 300i	09' - 14'	V-TECH LINE SPORT	5522	540 x 460	-120	(*)
DOWNTOWN 300i	09' - 14'	V-TECH LINE TOURING	6790	750 x 615	+130	(*)
GRAND DINK 125	16' - 18'	V-TECH LINE SPORT	5522			(*)
GRAND DINK 125	16' - 18'	V-TECH LINE TOURING	6790			(*)
GRAND DINK 300	16' - 18'	V-TECH LINE SPORT	5522			(*)
GRAND DINK 300	16' - 18'	V-TECH LINE TOURING	6790			(*)
G-DINK 50	12' - 18'	V-TECH LINE TOURING	6728	700 x 520	+200	(*)
G-DINK 125i	12' - 18'	V-TECH LINE TOURING	6728	700 x 520	+200	(*)
G-DINK 300i	12' - 18'	V-TECH LINE TOURING	6728	700 x 520	+200	(*)
K-XCT 125i	13' - 16'	V-TECH LINE TOURING	6810	790 x 520	+180	(*)
K-XCT 300i	13' - 16'	V-TECH LINE TOURING	6810	790 x 520	+180	(*)
NEW DOWNTOWN 125i	15' - 18'	V-TECH LINE TOURING	7664	820 x 615	+215	(*)
NEW DOWNTOWN 350i	15' - 18'	V-TECH LINE TOURING	7664	820 x 615	+215	(*)
SUPERDINK 125i	09' - 14'	V-TECH LINE SPORT	5522	540 x 460	-120	(*)
SUPERDINK 125i	09' - 14'	V-TECH LINE TOURING	6790	750 x 615	+130	(*)
SUPERDINK 125i	15' - 18'	V-TECH LINE TOURING	7664	820 x 615	+215	(*)
SUPERDINK 350i	09' - 14'	V-TECH LINE SPORT	5522	540 x 460	-120	(*)
SUPERDINK 350i	09' - 14'	V-TECH LINE TOURING	6790	750 x 615	+130	(*)
SUPERDINK 350i	15' - 18'	V-TECH LINE TOURING	7664	820 x 615	+215	(*)
XCITING 400i	14' - 16'	V-TECH LINE TOURING	6034	745 x 585	+165	(*)
XCITING 400i	17' - 18'	V-TECH LINE TOURING	9864	750 x 620	+100	(*)
XCITING 500i	07' - 13'	V-TECH LINE SPORT	5271	605 x 360	+0	(*)
X-TOWN 125	16' - 18'	V-TECH LINE SPORT	5522	540 x 460	-120	(*)
X-TOWN 125	16' - 18'	V-TECH LINE TOURING	6790	750 x 615	+130	(*)
X-TOWN 300	16' - 18'	V-TECH LINE SPORT	5522	540 x 460	-120	(*)
X-TOWN 300	16' - 18'	V-TECH LINE TOURING	6790	750 x 615	+130	(*)
YAGER GT 50	07' - 15'	V-TECH LINE TOURING	4539	490 x 440	+100	(*)
YAGER GT 125	07' - 15'	V-TECH LINE TOURING	4539	490 x 440	+100	(*)
YAGER GT 200i	07' - 15'	V-TECH LINE TOURING	4539	490 x 440	+100	(*)
YAGER GT 125i	13' - 18'	V-TECH LINE TOURING	6728	700 x 520	+200	(*)
YAGER GT 300i	13' - 18'	V-TECH LINE TOURING	6728	700 x 520	+200	(*)
MBK						
EVOLIS 125	10' - 18'	V-TECH LINE SPORT	6837	300 x 350	-130	(*)
EVOLIS 125	10' - 18'	V-TECH LINE TOURING	6259	560 x 430	+125	(*)
EVOLIS 250	10' - 18'	V-TECH LINE SPORT	6837	300 x 350	-130	(*)

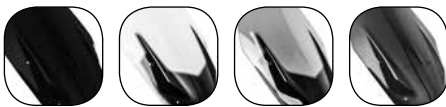

N Black **W** Transparent **H** Smoke **F** Dark Smoke

(*) Check price with your distributor.

IMPORTANT: Indicate code color after part#. Example: 0973A.

WINDSHIELDS FOR MAXISCOOTERS

HI-TECH PARTS | TYPE OF WINDSHIELD:

2019
MODELS:
www.puig.tv

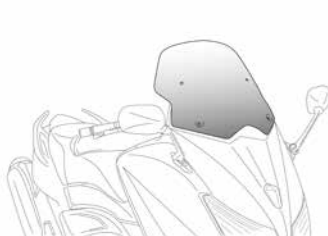

V-TECH LINE SPORT



V-TECH LINE TOURING

MODEL	YEAR	TYPE OF V-TECH LINE	REF.	DIMENSIONS (Height x Width)	HEIGHT (MM) Compared to OEM	
EVOLIS 250	10' - 18'	V-TECH LINE TOURING	6259	560 x 430	+125	(*)
EVOLIS 400	13' - 18'	V-TECH LINE SPORT	7503	365 x 370	-155	(*)
EVOLIS 400	13' - 18'	V-TECH LINE TOURING	6874	660 x 540	+140	(*)
PIAGGIO						
MP3 HYBRID 125ie	10' - 12'	V-TECH LINE SPORT	5845	515 x 470	-50	(*)
MP3 HYBRID 300ie	10' - 12'	V-TECH LINE SPORT	5845	515 x 470	-50	(*)
MP3 HYBRID LT 300ie	10' - 12'	V-TECH LINE SPORT	5845	515 x 470	-50	(*)
MP3 400ie	11'	V-TECH LINE SPORT	5845	515 x 470	-50	(*)
MP3 TOURING 400ie	12'	V-TECH LINE TOURING	5888	710 x 570	+80	(*)
MP3 TOURING 300ie	12'	V-TECH LINE TOURING	5888	710 x 570	+80	(*)
MP3 TOURING LT 400ie	12'	V-TECH LINE SPORT	5845	515 x 470	-50	(*)
MP3 TOURING LT 300ie	12'	V-TECH LINE TOURING	5888	710 x 570	+80	(*)
MP3 TOURING BUSINESS 500ie	12' - 13'	V-TECH LINE TOURING	5888	710 x 570	+80	(*)
MP3 TOURING BUSINESS LT 500ie	12' - 13'	V-TECH LINE TOURING	5888	710 x 570	+80	(*)
MP3 TOURING SPORT 500ie	12' - 13'	V-TECH LINE TOURING	5888	710 x 570	+80	(*)
MP3 TOURING SPORT LT 500ie	12' - 13'	V-TECH LINE TOURING	5888	710 x 570	+80	(*)
MP3 350	18'	V-TECH LINE TOURING	1666			(*)
MP3 125ie	11'	V-TECH LINE SPORT	5845	515 x 470	-50	(*)
MP3 300ie	11'	V-TECH LINE SPORT	5845	515 x 470	-50	(*)
MP3 250 RL	10'	V-TECH LINE SPORT	5845	515 x 470	-50	(*)
MP3 400 RL	10'	V-TECH LINE SPORT	5845	515 x 470	-50	(*)
MP3 400ie LT	10' - 11'	V-TECH LINE SPORT	5845	515 x 470	-50	(*)
MP3 300ie LT	10' - 11'	V-TECH LINE SPORT	5845	515 x 470	-50	(*)
MP3 300ie LT SPORT	13' - 14'	V-TECH LINE SPORT	5845	515 x 470	-50	(*)
MP3 BUSINESS LT 300ie	13' - 14'	V-TECH LINE TOURING	5888	710 x 570	+80	(*)
MP3 SPORT LT 500ie	13' - 14'	V-TECH LINE TOURING	5888	710 x 570	+80	(*)
MP3 BUSINESS LT 500ie	13' - 14'	V-TECH LINE TOURING	5888	710 x 570	+80	(*)
MP3 500 HPE ABS ASR	18'	V-TECH LINE TOURING	1666			(*)
MP3 500 HPE BUSINESS ABS ASR	18'	V-TECH LINE TOURING	1666			(*)
SUZUKI						
BURGMAN 125	07' - 13'	V-TECH LINE TOURING	4540	670 x 520	+120	(*)
BURGMAN 125	14' - 18'	V-TECH LINE TOURING	7019	735 x 560	+190	(*)

MODEL	YEAR	TYPE OF V-TECH LINE	REF.	DIMENSIONS (Height x Width)	HEIGHT (MM) Compared to OEM	
BURGMAN 200	07' - 13'	V-TECH LINE TOURING	4540	670 x 520	+120	(*)
BURGMAN 200	14' - 18'	V-TECH LINE TOURING	7019	735 x 560	+190	(*)
BURGMAN 400	17' - 18'	V-TECH LINE TOURING	9973	760 x 595	+220	(*)
BURGMAN 650/ EXECUTIVE	13' - 18'	V-TECH LINE TOURING	7309	770 x 530	+110	(*)
YAMAHA						
NMAX 125	15' - 18'	V-TECH LINE TOURING	8121	740 x 385	+350	(*)
MAJESTY 125 S	15' - 16'	V-TECH LINE TOURING	7665	605 x 510	+130	(*)
S-MAX	15' - 16'	V-TECH LINE TOURING	7665	605 x 510	+130	(*)
T-MAX 500	08' - 11'	V-TECH LINE SPORT	5031	650 x 450	-190	(*)
T-MAX 530	12' - 16'	V-TECH LINE SPORT	6036	400 x 350	-90	(*)
T-MAX 530	12' - 16'	V-TECH LINE TOURING	6260	590 x 425	+70	(*)
T-MAX 530	12' - 16'	V-TECH LINE SUPERSPORT	7499	330 x 470	- 210	(*)
T-MAX/DX/SX	17' - 18'	V-TECH LINE SPORT	9423	335 x 430		(*)
T-MAX/DX/SX	17' - 18'	V-TECH LINE TOURING	9424	675 x 555	+115	(*)
T-MAX/DX/SX	17' - 18'	V-TECH LINE SUPERSPORT	9841	250 x 220	-200	(*)
TRICITY	15' - 18'	V-TECH LINE TOURING	7666	710 x 520	+415	(*)
X-MAX 125	05' - 09'	V-TECH LINE TOURING	5015	370 x 410	+20	(*)
X-MAX 125	10' - 13'	V-TECH LINE SPORT	6837	300 x 350	-130	(*)
X-MAX 125	10' - 13'	V-TECH LINE TOURING	6259	560 x 430	+125	(*)
X-MAX 125	14' - 17'	V-TECH LINE SPORT	7503	366 x 370	-155	(*)
X-MAX 125	14' - 17'	V-TECH LINE TOURING	6874	660 x 540	+140	(*)
X-MAX 125	18'	V-TECH LINE SPORT	9474	430 x 350	-170	(*)
X-MAX 125	18'	V-TECH LINE TOURING	9476	715 x 570	+130	(*)
X-MAX 250	05' - 09'	V-TECH LINE TOURING	5015	370 x 410	+20	(*)
X-MAX 250	10' - 13'	V-TECH LINE SPORT	6837	300 x 350	-130	(*)
X-MAX 250	10' - 13'	V-TECH LINE TOURING	6259	560 x 430	+125	(*)
X-MAX 250	14' - 16'	V-TECH LINE SPORT	7503	366 x 370	-155	(*)
X-MAX 250	14' - 16'	V-TECH LINE TOURING	6874	660 x 540	+140	(*)
X-MAX 300	17' - 18'	V-TECH LINE SPORT	9474	430 x 350	-170	(*)
X-MAX 300	17' - 18'	V-TECH LINE TOURING	9476	715 x 570	+130	(*)
X-MAX 400	13' - 17'	V-TECH LINE SPORT	7503	366 x 370	-155	(*)
X-MAX 400	13' - 17'	V-TECH LINE TOURING	6874	660 x 540	+140	(*)
X-MAX 400	18'	V-TECH LINE SPORT	9474	430 x 350	-170	(*)
X-MAX 400	18'	V-TECH LINE TOURING	9476	715 x 570	+130	(*)

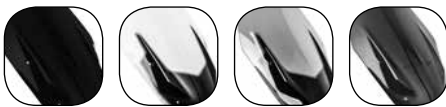

N Black **W** Transparent **H** Smoke **F** Dark Smoke

(*) Check price with your distributor.

IMPORTANT: Indicate code color after part#. Example: 0973A.





OEM



PUIG

Improvement on protection and aerodynamics.

// MOTORCYCLE HANDGUARDS

Designed for Naked and Adventure motorcycles in ABS.



// EXTENSION MOTORCYCLE HANDGUARDS

Ideal for some Adventure motorcycles.



// MAXISCOOTER HANDGUARDS

Maximum protection, made of PMMA.



HANDGUARDS

HI-TECH PARTS | TYPE OF HANDGUARDS:

2019
MODELS:
www.puig.tv

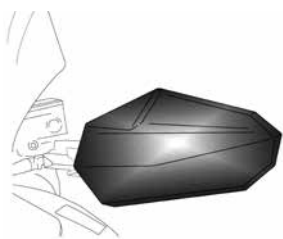

MAXISCOOTER HANDGUARDS

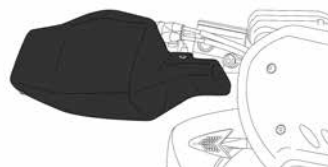

MOTORCYCLE HANDGUARDS

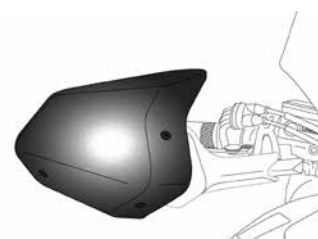

EXTENSION MOTORCYCLE HANDGUARDS

MODEL	YEAR	TYPE OF HANGUARDS	MATERIAL	ADHESIVE KIT	REF.	J	C	W H F T
BMW								
F750 GS	18'	EXTENSION	PMMA	NOT INCLUDED	8547			(*)
F800 R	09' - 14'	MOTORCYCLE	ABS	INCLUDED	9368	(*)		
F800 R	15' - 18'	MOTORCYCLE	ABS	INCLUDED	8939	(*)		
F800 GS	08' - 12'	MOTORCYCLE	ABS	INCLUDED	9368	(*)		
F800 GS	13' - 17'	MOTORCYCLE	ABS	INCLUDED	8939	(*)		
F800GS ADVENTURE	13' - 18'	EXTENSION	PMMA	NOT INCLUDED	8547			(*)
F850GS	18'	EXTENSION	PMMA	NOT INCLUDED	8547			(*)
G310 GS	17' - 18'	MOTORCYCLE	ABS	INCLUDED	9881	(*)		
G310 R	16' - 18'	MOTORCYCLE	ABS	INCLUDED	9881	(*)		
G650 GS	11' - 16'	MOTORCYCLE	ABS	INCLUDED	8937	(*)		
R1200 GS	13' - 18'	EXTENSION	PMMA	NOT INCLUDED	8547			(*)
R1200GS EXCLUSIVE	17' - 18'	EXTENSION	PMMA	NOT INCLUDED	8547			(*)
R1200GS RALLYE	17' - 18'	EXTENSION	PMMA	NOT INCLUDED	8547			(*)
R1200GS ADVENTURE	14' - 18'	EXTENSION	PMMA	NOT INCLUDED	8547			(*)
R1250GS	18'	EXTENSION	PMMA	NOT INCLUDED	8547			(*)
R1200 R	15' - 18'	MOTORCYCLE	ABS	INCLUDED	8940	(*)		
S1000 XR	15' - 18'	EXTENSION	PMMA	NOT INCLUDED	8547			(*)
R NINE T	14' - 18'	MOTORCYCLE	ABS	INCLUDED	9393	(*)		
R NINE T SCRAMBLER	15' - 18'	MOTORCYCLE	ABS	INCLUDED	9393	(*)		
DUCATI								
SCRAMBLER ICON/CLASSIC/FULL THROTTLE	15' - 18'	MOTORCYCLE	ABS	INCLUDED	8949	(*)		
SCRAMBLER SIXTY2	16' - 18'	MOTORCYCLE	ABS	INCLUDED	8949	(*)		
SCRAMBLER URBAN ENDURO	15' - 16'	MOTORCYCLE	ABS	INCLUDED	8949	(*)		
SCRAMBLER FLAT TRACK PRO	16'	MOTORCYCLE	ABS	INCLUDED	8949	(*)		
SCRAMBLER DESERT SLED	17' - 18'	MOTORCYCLE	ABS	INCLUDED	8949	(*)		
SCRAMBLER CAFE RACER	17' - 18'	MOTORCYCLE	ABS	INCLUDED	8949	(*)		
HONDA								
FORZA 125	15' - 18'	MAXISCOOTER	PMMA	NOT INCLUDED	9652			(*)
FORZA 300	18'	MAXISCOOTER	PMMA	NOT INCLUDED	9652			(*)
CB500F	16 - 18'	MOTORCYCLE	ABS	INCLUDED	9236	(*)		

MODEL	YEAR	TYPE OF HANGUARDS	MATERIAL	ADHESIVE KIT	REF.	J	C	W H F T
CB500X	13' - 18'	MOTORCYCLE	ABS	INCLUDED	8943	(*)		
CB650F	14' - 16'	MOTORCYCLE	ABS	INCLUDED	8944	(*)		
INTEGRA 750	14' - 18'	MAXISCOOTER	PMMA	NOT INCLUDED	9652			(*)
NC700X	12' - 13'	MOTORCYCLE	ABS	INCLUDED	8549	(*)		
NC750S	16' - 18'	MOTORCYCLE	ABS	INCLUDED	8549	(*)		
NC750X	14' - 18'	MOTORCYCLE	ABS	INCLUDED	8549	(*)		
CROSSRUNNER	15' - 18'	MOTORCYCLE	ABS	INCLUDED	8946	(*)		
CROSTOURER	12' - 18'	EXTENSION	PMMA	NOT INCLUDED	8947			(*)
CRF1000L AFRICA TWIN	16' - 18'	EXTENSION	PMMA	NOT INCLUDED	8948			(*)
SW-T400	09' - 15'	MAXISCOOTER	PMMA	NOT INCLUDED	8114			(*)
SW-T600	10' - 15'	MAXISCOOTER	PMMA	NOT INCLUDED	8114			(*)
PCX 125	14' - 18'	MAXISCOOTER	PMMA	NOT INCLUDED	9652			(*)
X-ADV	17' - 18'	MAXISCOOTER	PMMA	NOT INCLUDED	9652			(*)
KAWASAKI								
J125	16' - 18'	MAXISCOOTER	PMMA	NOT INCLUDED	9652			(*)
J300	14' - 18'	MAXISCOOTER	PMMA	NOT INCLUDED	9652			(*)
VERSYS 650	10' - 14'	MOTORCYCLE	ABS	INCLUDED	8952	(*)		
VERSYS 650	15' - 18'	MOTORCYCLE	ABS	INCLUDED	8951	(*)		
VERSYS 1000	15' - 18'	MOTORCYCLE	ABS	INCLUDED	8951	(*)		
Z650	17' - 18'	MOTORCYCLE	ABS	INCLUDED	9398	(*)		
Z900	17' - 18'	MOTORCYCLE	ABS	INCLUDED	9398	(*)		
KTM								
690 DUKE	16' - 18'	EXTENSION	PMMA	NOT INCLUDED	9622			(*)
690 DUKE R	16' - 17'	EXTENSION	PMMA	NOT INCLUDED	9622			(*)
790 DUKE	18'	EXTENSION	PMMA	NOT INCLUDED	9622			(*)
790 DUKE	18'	MOTORCYCLE	ABS	INCLUDED	0072	(*)		
990 SUPERMOTO	08' - 13'	EXTENSION	PMMA	NOT INCLUDED	9622			(*)
990 SUPERMOTO R	09' - 13'	EXTENSION	PMMA	NOT INCLUDED	9622			(*)
1050 ADVENTURE	15' - 16'	EXTENSION	PMMA	NOT INCLUDED	9622			(*)
1090 ADVENTURE/R	17' - 18'	EXTENSION	PMMA	NOT INCLUDED	9622			(*)
1190 ADVENTURE/R	13' - 16'	EXTENSION	PMMA	NOT INCLUDED	9622			(*)
1290 SUPERDUKE R	14' - 18'	EXTENSION	PMMA	NOT INCLUDED	9622			(*)
1290 SUPERDUKE GT	16' - 18'	MOTORCYCLE	ABS	INCLUDED	9186	(*)		
1290 SUPER ADVENTURE	15' - 16'	EXTENSION	PMMA	NOT INCLUDED	9622			(*)
1290 SUPER ADVENTURE T	17'	EXTENSION	PMMA	NOT INCLUDED	9622			(*)
1290 SUPER ADVENTURE R	17' - 18'	EXTENSION	PMMA	NOT INCLUDED	9622			(*)

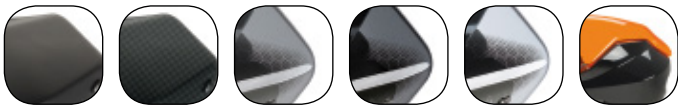

J Matt Black C Carbon Look H Smoke F Dark Smoke W Transparent T Orange

(*) Check price with your distributor.

IMPORTANT: Indicate code color after part#. Example: 0973A.

HANDGUARDS

HI-TECH PARTS | TYPE OF HANDGUARDS:

2019
MODELS:
www.puig.tv

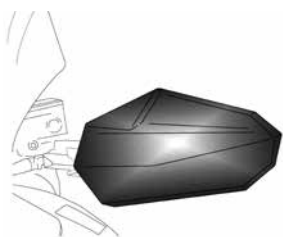

MAXISCOOTER HANDGUARDS

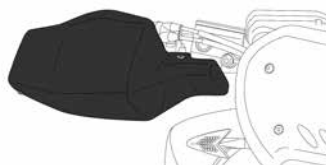

MOTORCYCLE HANDGUARDS

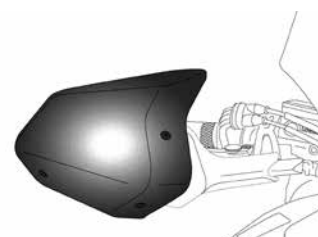

EXTENSION MOTORCYCLE HANDGUARDS

MODEL	YEAR	TYPE OF HANGUARDS	MATERIAL	ADHESIVE KIT	REF.	J	C	W H F T
1290 SUPER ADVENTURE S	17' - 18'	EXTENSION	PMMA	NOT INCLUDED	9622			(*)
KYMCO								
SUPERDINK 125i	09' - 18'	MAXISCOOTER	PMMA	NOT INCLUDED	9652			(*)
DOWNTOWN 125i	09' - 14'	MAXISCOOTER	PMMA	NOT INCLUDED	9652			(*)
SUPERDINK 350i	09' - 18'	MAXISCOOTER	PMMA	NOT INCLUDED	9652			(*)
DOWNTOWN 300i	09' - 14'	MAXISCOOTER	PMMA	NOT INCLUDED	9652			(*)
NEW DOWNTOWN 125i	15' - 18'	MAXISCOOTER	PMMA	NOT INCLUDED	9652			(*)
NEW DOWNTOWN 350i	15' - 18'	MAXISCOOTER	PMMA	NOT INCLUDED	9652			(*)
X-TOWN 125	16' - 18'	MAXISCOOTER	PMMA	NOT INCLUDED	9652			(*)
X-TOWN 300	16' - 18'	MAXISCOOTER	PMMA	NOT INCLUDED	9652			(*)
GRAND DINK 125	16' - 18'	MAXISCOOTER	PMMA	NOT INCLUDED	9652			(*)
GRAND DINK 300	16' - 18'	MAXISCOOTER	PMMA	NOT INCLUDED	9652			(*)
K-XCT 125i	13' - 16'	MAXISCOOTER	PMMA	NOT INCLUDED	9652			(*)
K-XCT 300i	13' - 16'	MAXISCOOTER	PMMA	NOT INCLUDED	9652			(*)
G-DINK 50	12' - 18'	MAXISCOOTER	PMMA	NOT INCLUDED	9652			(*)
G-DINK 125i	12' - 18'	MAXISCOOTER	PMMA	NOT INCLUDED	9652			(*)
G-DINK 300i	12' - 18'	MAXISCOOTER	PMMA	NOT INCLUDED	9652			(*)
YAGER GT 125i	13' - 18'	MAXISCOOTER	PMMA	NOT INCLUDED	9652			(*)
YAGER GT 300i	13' - 18'	MAXISCOOTER	PMMA	NOT INCLUDED	9652			(*)
XCITING 400i	14' - 16'	MAXISCOOTER	PMMA	NOT INCLUDED	9652			(*)
AK550	17' - 18'	MAXISCOOTER	PMMA	NOT INCLUDED	9652			(*)
SUZUKI								
BURGMAN 125	10' - 18'	MAXISCOOTER	PMMA	NOT INCLUDED	9652			(*)
BURGMAN 400	17' - 18'	MAXISCOOTER	PMMA	NOT INCLUDED	9652			(*)
DL1000 V-STROM	14' - 16'	MOTORCYCLE	ABS	INCLUDED	8950	(*)		
TRIUMPH								
SPEED TRIPLE/R	16' - 18'	MOTORCYCLE	ABS	INCLUDED	9255	(*)		
TIGER 800	11' - 14'	MOTORCYCLE	ABS	INCLUDED	8953	(*)		
TIGER 800 XC	11' - 14'	MOTORCYCLE	ABS	INCLUDED	8953	(*)		
TIGER 800 XC/XC/XCA	15' - 18'	MOTORCYCLE	ABS	INCLUDED	8953	(*)		
TIGER 800 XR/XRX/XRT	15' - 18'	MOTORCYCLE	ABS	INCLUDED	8953	(*)		

MODEL	YEAR	TYPE OF HANGUARDS	MATERIAL	ADHESIVE KIT	REF.	J	C	W H F T
YAMAHA								
NMAX 125	15' - 18'	MAXISCOOTER	PMMA	NOT INCLUDED	9652			(*)
MT-03	16' - 18'	MOTORCYCLE	ABS	INCLUDED	8897	(*)		
MT-07	14' - 18'	MOTORCYCLE TOURING	ABS	INCLUDED	8548	(*)		
MT-07	14' - 18'	MOTORCYCLE SPORT	ABS	INCLUDED	9161	(*)	(*)	
MT-07 TRACER	16 - 18'	EXTENSION	PMMA	NOT INCLUDED	9214			(*)
MT-09	13' - 18'	MOTORCYCLE TOURING	ABS	INCLUDED	8548	(*)		
MT-09	13' - 18'	MOTORCYCLE SPORT	ABS	INCLUDED	9161	(*)	(*)	
MT-09 SP	18'	MOTORCYCLE TOURING	ABS	INCLUDED	8548	(*)		
MT-09 SP	18'	MOTORCYCLE SPORT	ABS	INCLUDED	9161	(*)	(*)	
MT-09 TRACER	15' - 17'	EXTENSION	PMMA	NOT INCLUDED	8184			(*)
MT-09 TRACER	18'	EXTENSION	PMMA	NOT INCLUDED	9727			(*)
MT-10	16' - 18'	MOTORCYCLE TOURING	ABS	INCLUDED	8548	(*)		
MT-10	16' - 18'	MOTORCYCLE SPORT	ABS	INCLUDED	9161	(*)	(*)	
MT-10 SP	17' - 18'	MOTORCYCLE TOURING	ABS	INCLUDED	8548	(*)		
MT-10 SP	17' - 18'	MOTORCYCLE SPORT	ABS	INCLUDED	9161	(*)	(*)	
T-MAX 500	08' - 11'	MAXISCOOTER	PMMA	NOT INCLUDED	8112			(*)
T-MAX 530	12' - 16'	MAXISCOOTER	PMMA	NOT INCLUDED	8200			(*)
T-MAX 530/DX/SX	17' - 18'	MAXISCOOTER	PMMA	NOT INCLUDED	8200			(*)
T-MAX 530/DX/SX	17' - 18'	MAXISCOOTER	PMMA	NOT INCLUDED	9652			(*)
X-MAX 125	14' - 18'	MAXISCOOTER	PMMA	NOT INCLUDED	8111			(*)
X-MAX 250	14' - 16'	MAXISCOOTER	PMMA	NOT INCLUDED	8111			(*)
X-MAX 300	17' - 18'	MAXISCOOTER	PMMA	NOT INCLUDED	8111			(*)
X-MAX 400	13' - 18'	MAXISCOOTER	PMMA	NOT INCLUDED	8111			(*)
XSR 700	16' - 18'	MOTORCYCLE TOURING	ABS	INCLUDED	8548	(*)		
XSR 700	16' - 18'	MOTORCYCLE SPORT	ABS	INCLUDED	9161	(*)	(*)	
XSR 900	16' - 18'	MOTORCYCLE TOURING	ABS	INCLUDED	8548	(*)		
XSR 900	16' - 18'	MOTORCYCLE SPORT	ABS	INCLUDED	9161	(*)	(*)	

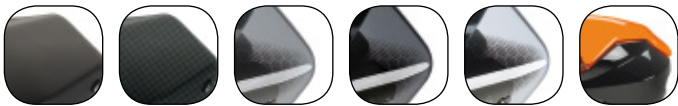

J Matt Black C Carbon Look H Smoke F Dark Smoke W Transparent T Orange

(*) Check price with your distributor.

IMPORTANT: Indicate code color after part#. Example: 0973A.

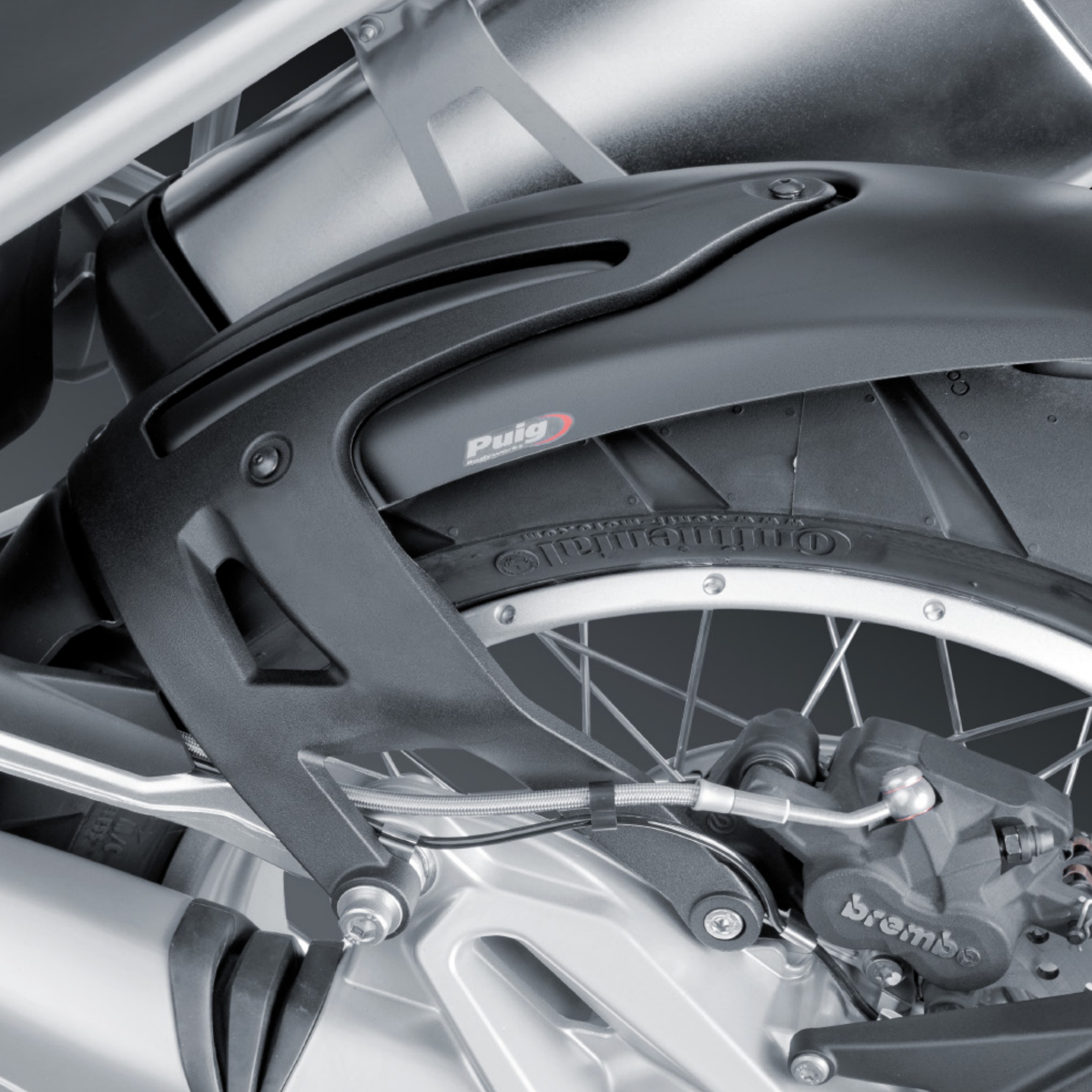

Puig
Puig.com

Continental
WWW.CONTINENTAL.COM

brembo

REARVIEW FENDERS

HI-TECH PARTS | TECHNICAL SECTION



Specific vanguard design for each bike, combined with the maximum protection against inclement weather.

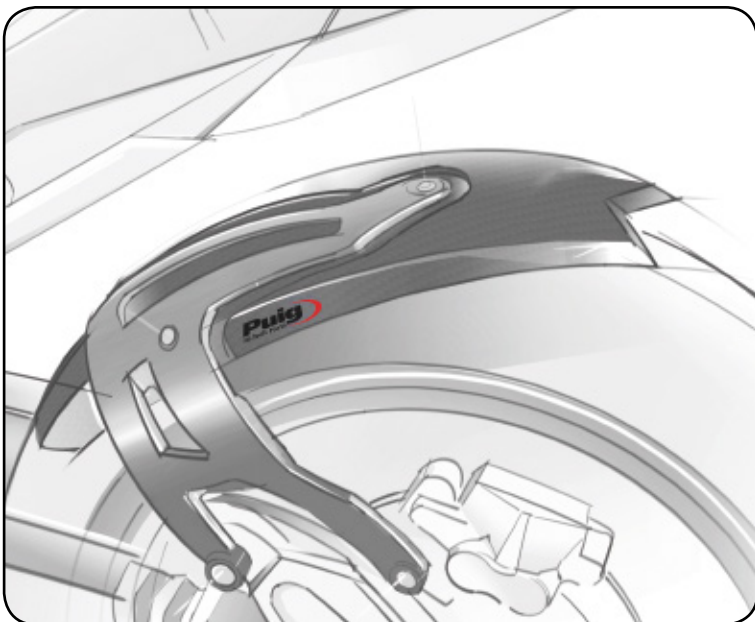

BMW R1200R 15'-17' (Part# 7682)

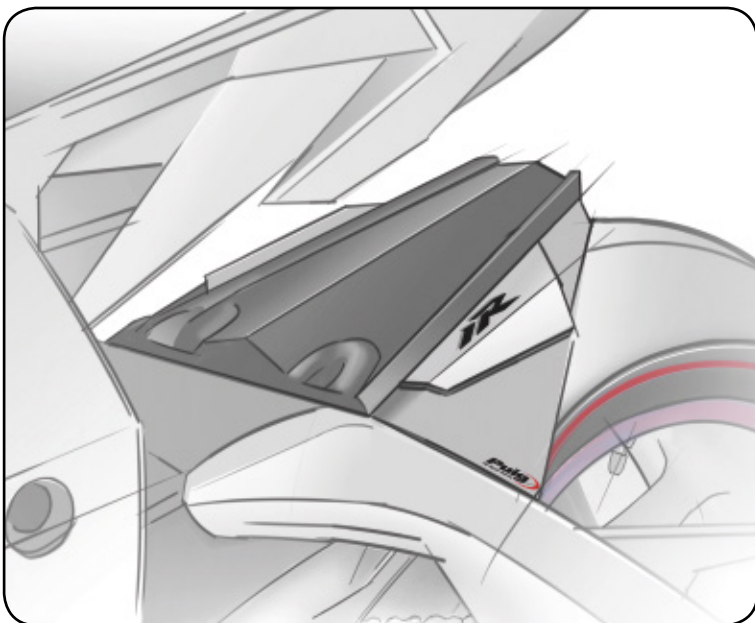

YAMAHA YZF-R1 15'-17' (Part# 7688)

// FENDER S

Maximum protection with a specific vanguard design.



// FENDER WITH ALUMINIUM SUPPORT

Support made of injected aluminum.



// FENDER R

Racing look with stainless steel detail.



REARVIEW FENDER

HI-TECH PARTS | TYPE OF FENDER:

2019
MODELS:
www.puig.tv

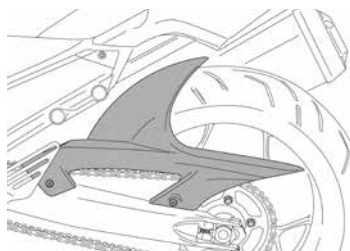

FENDER S

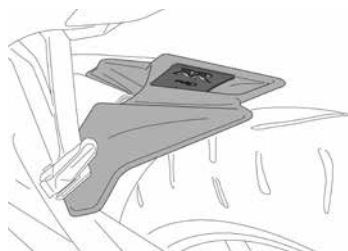

FENDER R



FENDER S WITH
ALUMINUM SUPPORT

MODEL	YEAR	TYPE OF FENDER	REFERENCE	J	C
APRILIA					
SHIVER 750	07' - 16'	FENDER S	4902	(*)	(*)
SHIVER 750 GT	08' - 16'	FENDER S	4902	(*)	(*)
SHIVER 900	17' - 18'	FENDER S	4902	(*)	(*)
BMW					
G310 GS	17' - 18'	FENDER S	9949	(*)	(*)
F650 GS	99' - 07'	FENDER S	5925	(*)	(*)
F650 GS	08' - 12'	FENDER S	5865	(*)	(*)
F700 GS	12' - 17'	FENDER S	6366	(*)	(*)
F750GS	18'	FENDER S	9761	(*)	(*)
F800 GS	08' - 17'	FENDER S	5865	(*)	(*)
F800 GS ADVENTURE	13' - 17'	FENDER S	5865	(*)	(*)
F800 GT	13' - 18'	FENDER S	6447	(*)	(*)
F800 R	09' - 18'	FENDER S	5882	(*)	(*)
F850GS	18'	FENDER S	9761	(*)	(*)
G650 GS	11' - 16'	FENDER S	5925	(*)	(*)
K1200 R	05' - 08'	FENDER WITH SUPPORT (NC) (#)	5887	(*)	(*)
K1200 R SPORT	07' - 08'	FENDER WITH SUPPORT (NC) (#)	5887	(*)	(*)
K1200 S	04' - 08'	FENDER WITH SUPPORT (NC) (#)	5887	(*)	(*)
K1300 R	09' - 16'	FENDER WITH SUPPORT (NC) (#)	5887	(*)	(*)
K1300 S	09' - 16'	FENDER WITH SUPPORT (NC) (#)	5887	(*)	(*)
R1100 GS	94' - 99'	FENDER WITH SUPPORT (NC) (#)	5886	(*)	(*)
R1150 GS	99' - 04'	FENDER WITH SUPPORT (NC) (#)	5886	(*)	(*)
R1150 GS ADVENTURE	02' - 05'	FENDER WITH SUPPORT (NC) (#)	5886	(*)	(*)
R1200 GS	04' - 12'	FENDER WITH SUPPORT (#)	5055	(*)	(*)
R1200 GS	13' - 17'	FENDER WITH SUPPORT (#)	6352	(*)	(*)
R1200 GS	18'	FENDER WITH SUPPORT (#)	1947	(*)	(*)
R1200GS EXCLUSIVE	17'	FENDER WITH SUPPORT (#)	6352	(*)	(*)
R1200GS RALLYE	17'	FENDER WITH SUPPORT (#)	6352	(*)	(*)

MODEL	YEAR	TYPE OF ENDER	REFERENCE	J	C
R1200GS EXCLUSIVE	18'	FENDER WITH SUPPORT (#)	1947	(*)	(*)
R1200GS RALLYE	18'	FENDER WITH SUPPORT (#)	1947	(*)	(*)
R1200 GS ADVENTURE	06' - 13'	FENDER WITH SUPPORT (#)	5055	(*)	(*)
R1200GS ADVENTURE	14' - 17'	FENDER WITH SUPPORT (#)	6352	(*)	(*)
R1200GS ADVENTURE	18'	FENDER WITH SUPPORT (#)	1947	(*)	(*)
R1250GS	18'	FENDER WITH SUPPORT (#)	1947	(*)	(*)
R1200 R	06' - 14'	FENDER WITH SUPPORT (#)	5861	(*)	(*)
R1200 R	15' - 18'	FENDER WITH SUPPORT (#)	7682	(*)	(*)
R1200 RS	15' - 18'	FENDER WITH SUPPORT (#)	7682	(*)	(*)
R1200 S	06' - 08'	FENDER WITH SUPPORT (#)	5861	(*)	(*)
R NINE T	14' - 18'	FENDER WITH SUPPORT (#)	7023	(*)	(*)
R NINE T URBAN G/S	17' - 18'	FENDER WITH SUPPORT (#)	7023	(*)	(*)
R NINE T PURE	17' - 18'	FENDER WITH SUPPORT (#)	7023	(*)	(*)
R NINE T RACER	17' - 18'	FENDER WITH SUPPORT (#)	7023	(*)	(*)
R NINE T SCRAMBLER	16' - 18'	FENDER WITH SUPPORT (#)	9464	(*)	(*)
DUCATI					
SCRAMBLER CAFE RACER	17' - 18'	FENDER S	9165	(*)	(*)
SCRAMBLER CLASSIC	15' - 18'	FENDER S	9165	(*)	(*)
SCRAMBLER ICON	15' - 18'	FENDER S	9165	(*)	(*)
SCRAMBLER FLAT TRACK PRO	16'	FENDER S	9165	(*)	(*)
SCRAMBLER FULL THROTTLE	15' - 18'	FENDER S	9165	(*)	(*)
HONDA					
CB500F	13' - 18'	FENDER S	6354	(*)	(*)
CB500X	13' - 18'	FENDER S	6354	(*)	(*)
CB600F HORNET	02' - 06'	FENDER S	1523	(*)	(*)
CB600F HORNET	07' - 15'	FENDER S	4403	(*)	(*)
CB600F HORNET ABS	08'	FENDER S	4403	(*)	(*)
CB1000R	08' - 16'	FENDER S (NC)	4692	(*)	(*)
CB1000RA	08' - 16'	FENDER S (NC)	4692	(*)	(*)
CB1300	02' - 10'	FENDER S (D)	1638	(*)	(*)
CBF500	04' - 07'	FENDER S	4127	(*)	(*)
CBF600	04' - 07'	FENDER S	4127	(*)	(*)
CBF600	08' - 14'	FENDER S	4691	(*)	(*)
CBF600 ABS	04' - 07'	FENDER S	4127	(*)	(*)
CBF600 ABS	08' - 14'	FENDER S	4691	(*)	(*)



J

Matt Black

C

Carbon Look

(*) Check price with your distributor.
 (D) Aluminium chainguard included.
 (NC) Keep original chainguard.
 (#) Rear hugger not compatible whit OFF-ROAD tires.

ATTENTION: If ABS does not appear behind bikes model, it means that it does not fit.

Previously verify any interference between our product and any other accessory (OEM or aftermarket) already installed on the motorcycle.

IMPORTANT: Indicate code color after part#. Example: 0973A.

REARVIEW FENDER

HI-TECH PARTS | TYPE OF FENDER:

2019
MODELS:
www.puig.tv

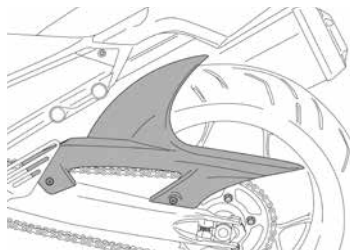

FENDER S

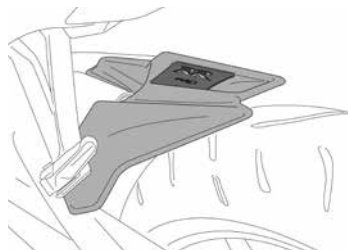

FENDER R



FENDER S WITH
ALUMINUM SUPPORT

MODEL	YEAR	TYPE OF FENDER	REFERENCE	J	C
CBF600S	04' - 07'	FENDER S	4127	(*)	(*)
CBF600S	08' - 14'	FENDER S	4691	(*)	(*)
CBF600S ABS	04' - 07'	FENDER S	4127	(*)	(*)
CBF600S ABS	08' - 14'	FENDER S	4691	(*)	(*)
CBF1000	06' - 09'	FENDER S	4127	(*)	(*)
CBF1000	10' - 11'	FENDER S	4691	(*)	(*)
CBF1000 ABS	10' - 11'	FENDER S	4691	(*)	(*)
CBF1000F	10' - 16'	FENDER S	4691	(*)	(*)
CBF1000F ABS	10' - 16'	FENDER S	4691	(*)	(*)
CBR600F	99' - 07'	FENDER S	1436	(*)	(*)
CBR600F	11' - 13'	FENDER S	4403	(*)	(*)
CBR500R	13' - 18'	FENDER S	6354	(*)	(*)
CBR600RR	07' - 16'	FENDER R	4404	(*)	(*)
CBR1000RR FIREBLADE	04' - 07'	FENDER R	2427	(*)	(*)
CBR1000RR FIREBLADE	12' - 13'	FENDER R	6037	(*)	(*)
CBR1000RR FIREBLADE/SP	14' - 16'	FENDER R	6037	(*)	(*)
CBR1100XX	97' - 07'	FENDER S	1445	(*)	(*)
CROSSTOURER	12' - 18'	FENDER S	6334	(*)	(*)
INTEGRA 700	12' - 13'	FENDER S	6038	(*)	(*)
INTEGRA 750	14' - 18'	FENDER S	7047	(*)	(*)
NC700S/X	12' - 13'	FENDER S	6038	(*)	(*)
NC750S/X	14' - 18'	FENDER S	6038	(*)	(*)
VFR1200F	10' - 16'	FENDER S	5276	(*)	(*)
KAWASAKI					
ER-6N	05' - 08'	FENDER S (NC)	4092	(*)	(*)
ER-6N	12' - 16'	FENDER S	6041	(*)	(*)
ER-6F	06' - 08'	FENDER S (NC)	4092	(*)	(*)
ER-6F	12' - 16'	FENDER S	6041	(*)	(*)
NINJA 300	13' - 17'	FENDER S	6843	(*)	(*)

MODEL	YEAR	TYPE OF ENDER	REFERENCE	J	C
Z300	15' - 17'	FENDER S	6843	(*)	(*)
VERSYS 650	07' - 18'	FENDER S (NC)	4407	(*)	(*)
Z750	07' - 12'	FENDER S	4524	(*)	(*)
Z750R	11' - 12'	FENDER S	4431	(*)	(*)
Z750S	05' - 06'	FENDER S	4524	(*)	(*)
Z800	13' - 16'	FENDER S	6462	(*)	(*)
Z800E	13' - 16'	FENDER S	6462	(*)	(*)
Z1000	07' - 09'	FENDER S	4431	(*)	(*)
ZX-6R	09' - 16'	FENDER R	5014	(*)	(*)
ZX-6R 636	13' - 16'	FENDER R	5014	(*)	(*)
ZX-10R	08' - 10'	FENDER R	4688	(*)	(*)
ZX-10R	11' - 15'	FENDER R	5678	(*)	(*)
ZX-10R	16' - 18'	FENDER R	5678	(*)	(*)
ZX-10RR	17' - 18'	FENDER R	5678	(*)	(*)
ZX-10R SE	18'	FENDER R	5678	(*)	(*)
ZZR1400	12' - 18'	FENDER S	6043	(*)	(*)
SUZUKI					
B-KING	08' - 11'	FENDER R	4834	(*)	(*)
DL250 V-STROM	17' - 18'	FENDER S	9592	(*)	(*)
DL650 V-STROM ABS	07' - 11'	FENDER S	4710	(*)	(*)
DL650 V-STROM	12' - 18'	FENDER S	4710	(*)	(*)
DL650XT V-STROM	15' - 18'	FENDER S	4710	(*)	(*)
DL1000 V-STROM	14' - 18'	FENDER S	6477	(*)	(*)
DL1000XT V-STROM	17' - 18'	FENDER S	6477	(*)	(*)
GSF650 BANDIT	07' - 11'	FENDER S	4412	(*)	
GSF650S BANDIT	07' - 14'	FENDER S	4412	(*)	
GSF1200 BANDIT	96' - 05'	FENDER S	1462	(*)	(*)
GSF1200S BANDIT	96' - 05'	FENDER S	1462	(*)	(*)
GSF1250 BANDIT	07' - 13'	FENDER S	4409	(*)	(*)
GSF1250S BANDIT	07' - 13'	FENDER S	4409	(*)	(*)
GSF1250S BANDIT ABS	07' - 13'	FENDER S	4409	(*)	(*)
GSX650F	08' - 17'	FENDER S	4412	(*)	
GSX1250F/FA	10' - 17'	FENDER S	4409	(*)	(*)
GSX1250F/FA ABS	10' - 17'	FENDER S	4409	(*)	(*)
GSX1400	01' - 06'	FENDER S (D)	1471	(*)	(*)



J

Matt Black

C

Carbon Look

(*) Check price with your distributor.

(D) Aluminium chainguard included.

(NC) Keep original chainguard.

#) Rear hugger not compatible whit OFF-ROAD tires.

ATTENTION: If ABS does not appear behind bikes model, it means that it does not fit.

Previously verify any interference between our product and any other accessory (OEM or aftermarket) already installed on the motorcycle.

IMPORTANT: Indicate code color after part#. Example: 0973A.

REARVIEW FENDER

HI-TECH PARTS | TYPE OF FENDER:

2019
MODELS:
www.puig.tv

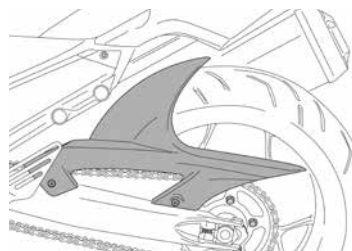

FENDER S

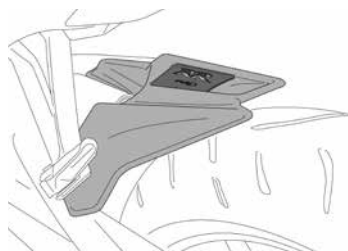

FENDER R



FENDER S WITH
ALUMINUM SUPPORT

MODEL	YEAR	TYPE OF FENDER	REFERENCE	J	C
GSX-R600	04' - 05'	FENDER S	1643	(*)	(*)
GSX-R600	06' - 10'	FENDER R	4089	(*)	(*)
GSX-R750	00' - 03'	FENDER S	1466	(*)	(*)
GSX-R750	04' - 05'	FENDER S	1643	(*)	(*)
GSX-R750	06' - 10'	FENDER R	4089	(*)	(*)
GSX-R1000	03' - 04'	FENDER S	1466	(*)	(*)
GSX-R1000	05' - 08'	FENDER R	2524	(*)	
GSX-R1000	09' - 16'	FENDER R	5059	(*)	(*)
GSX-R1000/R	17' - 18'	FENDER R	8999	(*)	(*)
GSX-R1300 HAYABUSA	08' - 17'	FENDER S	4693	(*)	(*)
SFV650 GLADIUS	09' - 15'	FENDER S	5019	(*)	(*)
SV650	16' - 18'	FENDER S	5019	(*)	(*)
SV650X	18'	FENDER S	5019	(*)	(*)
TRIUMPH					
TIGER 800/XC	11' - 14'	FENDER S	6040	(*)	(*)
TIGER 800 XC/XCX/XCA	15' - 18'	FENDER S	6040	(*)	(*)
TIGER 800 XR/XRX/XRT	15' - 18'	FENDER S	6040	(*)	(*)
TIGER EXPLORER	12' - 15'	FENDER WITH SUPPORT	6465	(*)	(*)
TIGER EXPLORER XC	13' - 15'	FENDER WITH SUPPORT	6465	(*)	(*)
TIGER EXPLORER XC/XR/XRX/XRT/XCX/XCA	16' - 18'	FENDER WITH SUPPORT	8595	(*)	(*)
YAMAHA					
FZS1000 FAZER	01' - 05'	FENDER S	1474	(*)	(*)
MT-03	16' - 18'	FENDER S	8558	(*)	(*)
MT-07	14' - 18'	FENDER S	7048	(*)	(*)
MT-07 TRACER	16' - 18'	FENDER S	9205	(*)	(*)
XSR700	16' - 18'	FENDER S	7048	(*)	(*)
XJ6/DIVERSION	09' - 16'	FENDER S	5035	(*)	(*)
XJ6 DIVERSION F	10' - 16'	FENDER S	5035	(*)	(*)
XJR1200	94' - 98'	FENDER S (D)	1477	(*)	(*)

MODEL	YEAR	TYPE OF ENDER	REFERENCE	J	C
XJR1300	99' - 13'	FENDER S (D)	1477	(*)	(*)
YZF-R1	07' - 08'	FENDER R	4405		(*)
YZF-R1	09' - 14'	FENDER R	5017		(*)
YZF-R1	15' - 18'	FENDER R	7688	(*)	(*)
YZF-R1M	17' - 18'	FENDER R	7688	(*)	(*)
YZF-R3	15' - 18'	FENDER S	8558	(*)	(*)
YZF-R6	06' - 15'	FENDER R	4087	(*)	(*)
YZF-R6	17' - 18'	FENDER R	4087	(*)	(*)
YZF-R6 S	05' - 07'	FENDER R	4087	(*)	(*)



J Matt Black
C Carbon Look

(*) Check price with your distributor.
(D) Aluminium chainguard included.
(NC) Keep original chainguard.
(#) Rear hugger not compatible whit OFF-ROAD tires.

ATTENTION: If ABS does not appear behind bikes model, it means that it does not fit.

Previously verify any interference between our product and any other accessory (OEM or aftermarket) already installed on the motorcycle.

IMPORTANT: Indicate code color after part#. Example: 0973A.

HI-TECH PARTS

Puig
Racing Screws



REARVIEW FENDER EXTENSION

HI-TECH PARTS | TECHNICAL SECTION

2019
MODELS:
www.puig.tv

123

MODEL	YEAR	REF.	J
BENELLI			
LEONCINO 500	16' - 18'	9905	(*)
BMW			
S1000 R	14' - 18'	9885	(*)
S1000 RR	09' - 18'	9885	(*)
DUCATI			
MONSTER 821	14' - 18'	9886	(*)
SUPERSPORT 939/S	17' - 18'	9887	(*)
HONDA			
CB1000R NEO SPORTS CAFE	18'	1803	(*)
CBR600RR	08' - 12'	9888	(*)
CBR1000RR FIREBLADE	08' - 11'	9889	(*)
CBR1000RR FIREBLADE	12'	9891	(*)
CBR1000RR FIREBLADE	13' - 16'	9891	(*)
CBR1000RR FIREBLADE/SP/SP2	17'	9891	(*)
KAWASAKI			
ER-6N	09' - 11'	9892	(*)
ER-6F	06' - 08'	9892	(*)
Z1000	10' - 16'	9893	(*)
Z1000SX	11' - 16'	9893	(*)
Z1000/SX	17' - 18'	9894	(*)
VERSYS-X 300	17' - 18'	9895	(*)
Z300	15' - 17'	9896	(*)
NINJA 300	13' - 17'	9896	(*)
NINJA 400	18'	1811	(*)
Z650	17' - 18'	9790	(*)
NINJA 650	17' - 18'	9790	(*)
Z800	13' - 16'	9897	(*)
Z800E	13' - 16'	9896	(*)
Z900	17' - 18'	0022	(*)
Z900RS	18'	0022	(*)
ZX-10R	11'-18'	1939	(*)
KTM			
1290 SUPERDUKE GT	16' - 18'	9898	(*)
125 DUKE	11' - 16'	9899	(*)
125 DUKE	17' - 18'	1882	(*)

MODEL	YEAR	REF.	J
200 DUKE	12' - 15'	9899	(*)
390 DUKE	13' - 16'	9899	(*)
390 DUKE	17' - 18'	1882	(*)
690 DUKE	16' - 18'	9900	(*)
690 DUKE R	16' - 17'	9900	(*)
790 DUKE	18'	0024	(*)
SUZUKI			
GSX-S750	17' - 18'	9901	(*)
GSR750	11' - 16'	9902	(*)
GSX-R600	06' - 07'	9903	(*)
GSX-R750	06' - 07'	9903	(*)
GSX-S1000	15' - 18'	9904	(*)
GSX-S1000F	15' - 18'	9904	(*)
TRIUMPH			
STREET TRIPLE	07' - 12'	9906	(*)
STREET TRIPLE R	09' - 12'	9906	(*)
STREET TRIPLE/R	13' - 18'	9906	(*)
TIGER 1050	07' - 13'	9907	(*)
TIGER SPORT	13' - 18'	9908	(*)
YAMAHA			
FZ1	06' - 15'	9909	(*)
FZ8	10' - 16'	9909	(*)
MT-09	13' - 18'	9910	(*)
MT-09 TRACER	18'	0016	(*)
MT-09 TRACER GT	18'	0016	(*)
XSR 900	16' - 18	9910	(*)
MT-07	14' - 18'	9911	(*)
MT-07 TRACER	16' - 18'	9912	(*)
XSR700	16' - 18'	9911	(*)
MT-10	16' - 18'	9912	(*)
YZF-R1	15' - 18'	9913	(*)
YZF-R6	17' - 18'	9914	(*)



J

Matt Black

Manufactured in ABS plastic. Supplied with self-tapping screws to mount on the oem fender.

Only suitable for oem fenders.

(*) Check price with your distributor.

IMPORTANT: Indicate code color after part#. Example: 0973A.





MODEL	YEAR	REF.	N
HARLEY DAVIDSON			
SPORTSTER 883 IRON	09' - 18'	9992	(*)
HONDA			
CMX 500 REBEL	17' - 18'	9670	(*)
INDIAN			
SCOUT BOBBER	18'	9739	(*)
KAWASAKI			
VULCAN S	15' - 18'	9673	(*)
VULCAN S CAFE	17' - 18'	9673	(*)

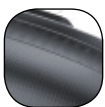

N
Black

(*) Check price with your distributor.

IMPORTANT: Indicate code color after part#. Example: 0973A.

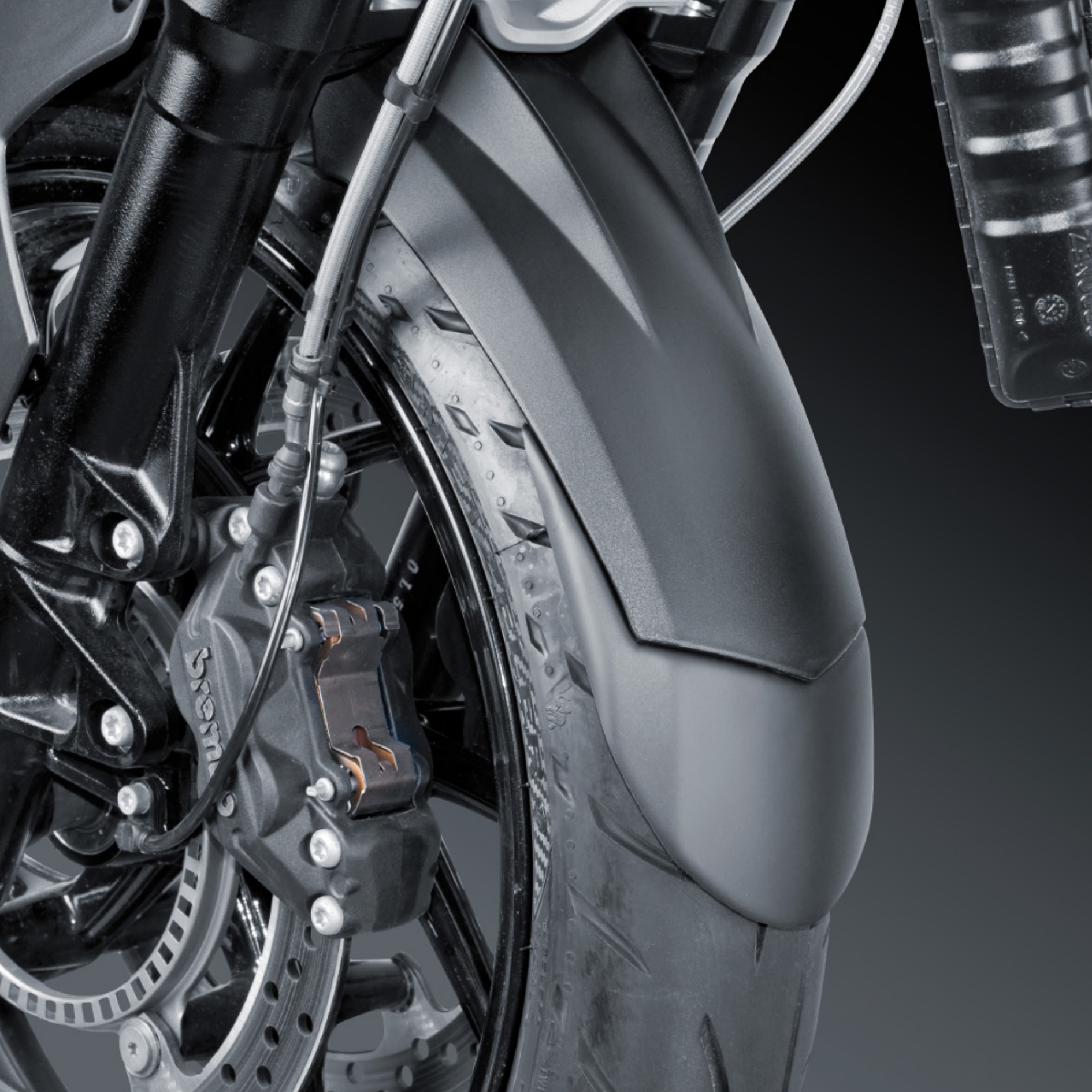

FRONT FENDER EXTENSION

HI-TECH PARTS | TECHNICAL SECTION

2019
MODELS:
www.puig.tv

127

MODEL	YEAR	REF.	N
APRILIA			
CAPONORD 1200	13' - 16'	9284	(*)
CAPONORD 1200 RALLY	15' - 16'	9284	(*)
MANA 850	07' - 16'	9940	(*)
SHIVER 750	07' - 16'	5798	(*)
SHIVER 750 GT	08' - 13'	5798	(*)
BMW			
F650 GS	08' - 12'	5783	(*)
F700 GS	12' - 17'	6821	(*)
F750 GS	18'	1941	(*)
F800 GS	08' - 17'	5785	(*)
F850 GS	18'	1942	(*)
F800 R	09' - 14'	5786	(*)
F800 S	06' - 11'	5786	(*)
F800 ST	06' - 13'	5786	(*)
F800 R	15' - 18'	9020	(*)
G310GS	17' - 18'	9916	(*)
G310R	17' - 18'	9812	(*)
G650 GS	10' - 16'	6177	(*)
K1200 S	04' - 08'	6172	(*)
K1200 R SPORT	07' - 08'	6172	(*)
K1300 S	09' - 16'	6172	(*)
K1200R	05' - 08'	9814	(*)
K1300R	09' - 16'	9814	(*)
K1600 GT	11' - 18'	6168	(*)
K1600 GTL	11' - 18'	6168	(*)
R850 GS	98' - 01'	9813	(*)
R1100 GS	94' - 99'	9813	(*)
R1100S	98' - 05'	6430	(*)
R1150 GS	99' - 04'	6164	(*)
R1200 C	97' - 04'	6431	(*)
R1200 GS	04' - 12'	5784	(*)
R1200 GS	13' - 18'	6822	(*)
R1200 GS	13' - 18'	9202 (+)	(*)
R1200GS EXCLUSIVE	17' - 18'	9202 (+)	(*)
R1200GS RALLYE	17' - 18'	9202 (+)	(*)
R1200 RT	05' - 13'	6160	(*)
R1200 RT	14' - 18'	8487	(*)
R850C/GS	98' - 01'	6167	(*)
R1150 RT	01' - 04'	6167	(*)
R1100 S	98' - 05'	6430	(*)
R1100 R	94' - 00'	6429	(*)
R1200 R	06' - 10'	5661	(*)
R1200 R	11' - 14'	9021	(*)

MODEL	YEAR	REF.	N
R1200 R	15' - 18'	9022	(*)
R1200 RS	15' - 18'	9203 (*)	(*)
R NINE T	14' - 18'	8186	(*)
R NINE T SCRAMBLER	16' - 18'	9815	(*)
S1000 R	14' - 18'	8084	(*)
S1000 RR	09' - 18'	8084	(*)
S1000 XR	15' - 18'	8084	(*)
DUCATI			
DIAVEL	11' - 18'	6178	(*)
MONSTER 696	08' - 14'	6415	(*)
MONSTER 796	10' - 14'	6415	(*)
MONSTER 1100	09' - 10'	6415	(*)
MONSTER 1100 EVO	11' - 13'	6415	(*)
MONSTER 1200/S	14' - 18'	6415	(*)
MULTISTRADA 1200/S	10' - 17'	6416	(*)
MULTISTRADA 1200 ENDURO	16' - 17'	9816	(*)
MULTISTRADA 950	17' - 18'	9816	(*)
SCRAMBLER ICON	15' - 18'	9023	(*)
HARLEY DAVIDSON			
XL/FXDB/FXDL/FXDS/FXD/FXD/ FXDX/ FXDXT/ FXDC			
/FXDWG/ XLH/ FXSTD/ FXST/ FXDXT/ FXSTC		6170	(*)
X-R/V-ROD		6175	(*)
HONDA			
MSX125	14' - 15'	9817	(*)
MSX125	16' - 18'	9818	(*)
CMX 500 REBEL	17' - 18'	9819	(*)
CB500F	13' - 18'	7339	(*)
CB500X	13' - 18'	7339	(*)
CBR500R	13' - 18'	7339	(*)
CB650F	14' - 18'	8488	(*)
CBR650F	14' - 18'	8488	(*)
CBF500	04' - 07'	5800	(*)
CBF600	04' - 14'	5800	(*)
CBF1000	06' - 11'	5800	(*)
CBR1100XX BLACKBIRD	97' - 07'	6432	(*)
CBRF1000L AFRICA TWIN	16' - 18'	9375	(*)
CB1100EX	17' - 18'	9820	(*)
CB1000R	08' - 16'	9821	(*)
CB1000R NEO SPORTS CAFE	18'	0049	(*)
CB1100 RS	17' - 18'	9822	(*)
CBR1000RR FIREBLADE	04' - 05'	9917	(*)
CBR1000RR FIREBLADE	06' - 07'	9918	(*)
CBR1000RR FIREBLADE	08' - 13'	8163	(*)
CBR1000RR FIREBLADE/SP	14' - 16'	8163	(*)



N
Black

(*) Fixation with glue.

(+) Bigger extension. Check image on our site.

Manufactured in ABS plastic. Supplied with self-tapping screws to mount on the oem fender.

IMPORTANT: Indicate code color after part#. Example: 0973A.

FRONT FENDER EXTENSION

HI-TECH PARTS

2019
MODELS:
www.puig.tv

MODEL	YEAR	REF.	N
CBR1000RR FIREBLADE SP/ SP2	17' - 18'	8163	(*)
VTR1000 SP-1	00' - 02'	9919	(*)
VTR1000 SP-2	02' - 05'	9919	(*)
CROSSRUNNER	11' - 14'	6179	(*)
CROSSRUNNER	15' - 18'	8163	(*)
CROSSTOURER	12' - 18'	6417	(*)
CB600F HORNET	05' - 16'	6426	(*)
CB900F HORNET	02' - 05'	6171	(*)
INTEGRA	12' - 13'	6302	(*)
INTEGRA 750	14' - 18'	6302	(*)
NC700X/S	12' - 13'	6418	(*)
NC750X	14' - 18'	6418	(*)
NT700V DEAUVILLE	06' - 12'	5801	(*)
PAN-EUROPEAN	02' - 13'	5805	(*)
CTX1300 DX	14' - 17'	9823	(*)
VFR800	02' - 13'	5803	(*)
VFR800F	14' - 18'	8163	(*)
VFR1200F	10' - 16'	5804	(*)
XL650V TRANSALP	00' - 07'	9920	(*)
XL700V TRANSALP	08' - 12'	5802	(*)
XL1000V TRANSALP	03' - 11'	5799	(*)
X-ADV	17' - 18'	9824	(*)
INDIAN SCOUT			
SCOUT	15' - 18'	9825 (*)	(*)
KAWASAKI			
NINJA 250R	08' - 12'	9921	(*)
VERSYS X-300	17' - 18'	9922	(*)
ER-6F/N	09' - 11'	6419	(*)
ER-6F/N	12' - 16'	6420	(*)
VERSYS 650	07' - 09'	5778	(*)
VERSYS 650	10' - 18'	5779	(*)
VERSYS 1000	12' - 18'	5779	(*)
VULCAN S	15' - 18'	9024	(*)
VULCAN S CAFE	17' - 18'	9024	(*)
Z1000	03' - 06'	6419	(*)
Z750S	05' - 06'	6419	(*)
Z750	07' - 12'	5781	(*)
Z750R	11' - 12'	6422	(*)
NINJA 400	18'	1940	(*)
NINJA 650	17' - 18'	9827	(*)
Z650	17' - 18'	9827	(*)
Z800/E	13' - 16'	8489	(*)
Z900	17' - 18'	9828	(*)
Z1000	07' - 09'	5780	(*)

MODEL	YEAR	REF.	N
Z1000	10' - 13'	5782	(*)
Z1000	14' - 18'	8489	(*)
Z1000SX	11' - 18'	6423	(*)
ZX-10R	04' - 07'	9923	(*)
ZX-10R	08' - 10'	9924	(*)
ZX-10R	11' - 16'	6423	(*)
ZX-10R/RR	17' - 18'	9865	(*)
ZZR1200	02' - 05'	9925	(*)
ZZR1400	06' - 18'	6163	(*)
GTR1400	07' - 18'	6163	(*)
KTM			
125 DUKE	11' - 16'	9926	(*)
125 DUKE	17' - 18'	9927	(*)
200 DUKE	12 - 15'	9926	(*)
390 DUKE	13' - 16'	9926	(*)
390 DUKE	17' - 18'	9927	(*)
690 DUKE	08' - 11'	9928	(*)
790 DUKE	18'	9929	(*)
990 SUPERDUKE /R	07' - 13'	6169	(*)
990 SUPERMOTO/R	08' - 13'	6169	(*)
1290 SUPERDUKE R	14' - 18'	9025	(*)
1050 ADVENTURE	15' - 16'	9026	(*)
1190 ADVENTURE/R	13' - 16'	9026	(*)
1290 SUPER ADVENTURE	15' - 16'	9026	(*)
1290 SUPER ADVENTURE T	17'	9026	(*)
1290 SUPER ADVENTURE R	17' - 18'	9026	(*)
1290 SUPER ADVENTURE S	17' - 18'	9026	(*)
SUZUKI			
GSX-R125	17' - 18'	9930	(*)
GSX-S125	17' - 18'	9930	(*)
BURGMAN 400	07' - 18'	9829	(*)
BURGMAN 650	02' - 11'	9830	(*)
BURGMAN 650	12' - 18'	9831	(*)
DL250 V-STROM	17' - 18'	0030	(*)
DL650 V-STROM	04' - 11'	5791	(*)
DL1000 V-STROM	04' - 07'	5791	(*)
DL650 V-STROM	12' - 18'	6159	(*)
DL650XT V-STROM	15' - 18'	6159	(*)
GSF600S BANDIT	00' - 04'	6433	(*)
GSF650 BANDIT	09' - 11'	5789	(*)
GSF650S BANDIT	09' - 14'	5789	(*)
GSF1200S BANDIT	96' - 00'	5787	(*)
GSF1200S BANDIT	01' - 05'	5787	(*)
GSF1200S BANDIT	06'	6433	(*)



N
Black

(*) Fixation with glue.

(+) Bigger extension. Check image on the our site.

Manufactured in ABS plastic. Supplied with self-tapping screws to mount on the oem fender.

IMPORTANT: Indicate code color after part#. Example: 0973A.

MODEL	YEAR	REF.	N
GSR600	06' - 11'	5792	(*)
GSR750	11' - 16'	6176	(*)
GSX-R600	01' - 03'	9936	(*)
GSX-R600	04' - 05'	9937	(*)
GSX-R600	11' - 17'	9938	(*)
GSX-R750	00' - 02'	9936	(*)
GSX-R750	03' - 05'	9937	(*)
GSX-R750	11' - 17'	9938	(*)
GSX-R1000	01' - 02'	9936	(*)
GSX-R1000	03' - 04'	9937	(*)
GSX-R1000	09' - 16'	9938	(*)
GSX-R1000/R	17' - 18'	9931	(*)
GSX-R1300 HAYABUSA	99' - 07'	9932	(*)
GSX-R1300 HAYABUSA	08' - 17'	9933	(*)
B-KING	08' - 11'	9934	(*)
GSX650F	08' - 17'	5790	(*)
GSX1250F	10' - 17'	5790	(*)
GSX-S1000	15' - 17'	8493	(*)
GSX-S1000F	15' - 17'	8493	(*)
SV650	05' - 08'	6165	(*)
SV650S	03' - 08'	6165	(*)
SV1000	03' - 05'	6165	(*)
SV1000S	03' - 05'	6165	(*)
SV650 GLADIUS	09' - 15'	9832	(*)
SV650	16' - 18'	9285	(*)
TRIUMPH			
BONNEVILLE T100/T120	16' - 18'	9833	(*)
STREET TWIN	16' - 18'	9224	(*)
STREET CUP	17' - 18'	9224	(*)
STREET SCRAMBLER	17' - 18'	9224	(*)
BONNEVILLE SE	09' - 15'	6435	(*)
DAYTONA 600	03' - 04'	5788	(*)
DAYTONA 650	05'	5788	(*)
DAYTONA 675	06' - 16'	5788	(*)
DAYTONA 675 R	11' - 16'	5788	(*)
STREET TRIPLE	08' - 16'	5788	(*)
STREET TRIPLE R	09' - 16'	5788	(*)
STREET TRIPLE/R	17' - 18'	5788	(*)
SPEED TRIPLE	11' - 15'	6424	(*)
SPEED TRIPLE R	12' - 15'	6424	(*)
SPEED TRIPLE/R	16' - 18'	6424	(*)
SCRAMBLER	06' - 16'	9287	(*)
TIGER 800/XC	11' - 14'	6173	(*)
TIGER 800 XC/XCX/XCA/XR/XRX/XRT	11' - 18'	9288	(*)

MODEL	YEAR	REF.	N
TIGER 1050	07' - 13'	6161	(*)
TIGER SPORT	13' - 18'	9128	(*)
TIGER EXPLORER	12' - 15'	6425	(*)
TIGER EXPLORER XC	13' - 15'	6425	(*)
TIGER EXPLORER XC/XR/XRX/XRT/XCX/XCA	16' - 18'	9223	(*)
YAMAHA			
MT-125	14' - 18'	9834	(*)
YZF-R125	14' - 18'	9834	(*)
FJR1300A/AS	06' - 12'	6166	(*)
FZ6 S2	07' - 10'	5794	(*)
FZ6 FAZER S2	07' - 10'	5794	(*)
FZ6	04' - 08'	5795	(*)
FZ6 FAZER	04' - 08'	5795	(*)
FZ8	10' - 16'	5795	(*)
FZ8 FAZER	10' - 12'	5795	(*)
FAZER8	13' - 16'	5795	(*)
FZ1	06' - 15'	5795	(*)
FZ1 FAZER	06' - 15'	5795	(*)
MT-03	16' - 18'	9182	(*)
MT-07	14' - 17'	7565	(*)
MT-07	18'	0031	(*)
MT-07 TRACER	16' - 18'	9237	(*)
MT-09	13' - 18'	7512	(*)
MT-09 TRACER	15' - 17'	7512	(*)
MT-10	16' - 18'	9835	(*)
MT-10 SP	17' - 18'	9835	(*)
YZF-R125	08' - 18'	9935	(*)
YZF-R1	09' - 18'	9385	(*)
YZF-R3	15' - 18'	9182	(*)
YZF-R6	17' - 18'	9385	(*)
XSR700	16' - 18'	9183	(*)
XSR900	16' - 18'	9184	(*)
XV950	14'-18'	9289	(*)
XV950R	14'-18'	9289	(*)
XV950 RACER	16'	9289	(*)
TDM 900	02' - 13'	5797	(*)
TRX850	96' - 99'	6434	(*)
XJR1200	94' - 98'	6434	(*)
XJR1300	02' - 16'	6434	(*)
XJ6	09' - 16'	9836	(*)
XJ6 DIVERSION	09' - 16'	9836	(*)
XJ6 DIVERSION F	10' - 16'	9836	(*)
XT660Z TÉNÉRÉ	08' - 16'	9836	(*)
XT1200Z SUPER TÉNÉRÉ	10' - 18'	6162	(*)



N
Black

(*) Fixation with glue.

(+) Bigger extension. Check image on the our site.

Manufactured in ABS plastic. Supplied with self-tapping screws to mount on the oem fender.

IMPORTANT: Indicate code color after part#. Example: 0973A.



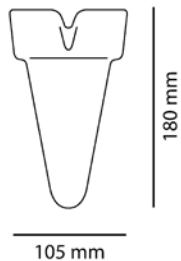

// URBAN UNIVERSAL

MODEL	REF.	N
URBAN UNIVERSAL	6413	(*)

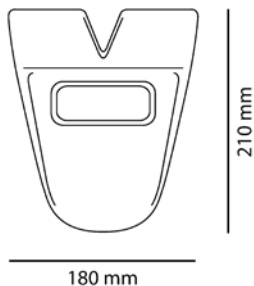

// TOUR UNIVERSAL

MODEL	REF.	N
TOUR UNIVERSAL	6412	(*)

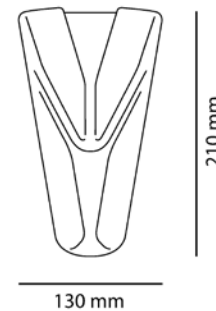

// URBAN HONDA

MODEL	REF.	N
URBAN HONDA NC700X/S - INTEGRA	6428	(*)

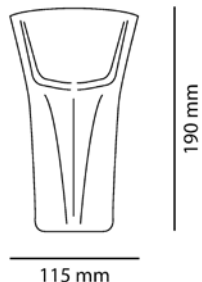

// TOUR YAMAHA

MODEL	REF.	N
TOUR YAMAHA FZ1/FZ8	6427	(*)

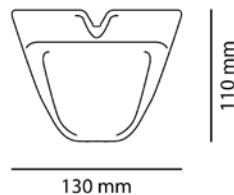

// SPORT UNIVERSAL

MODEL	REF.	N
SPORT UNIVERSAL	6414	(*)

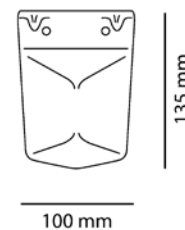

// TOUR DUCATI

MODEL	REF.	N
TOUR DUCATI	6675	(*)



N
Black

Manufactured in ABS plastic. It is supplied with 3M sticker to N-Black fix it to the hugger.

(*) Check price with your distributor.

IMPORTANT: Indicate code color after part#. Example: 0973A.

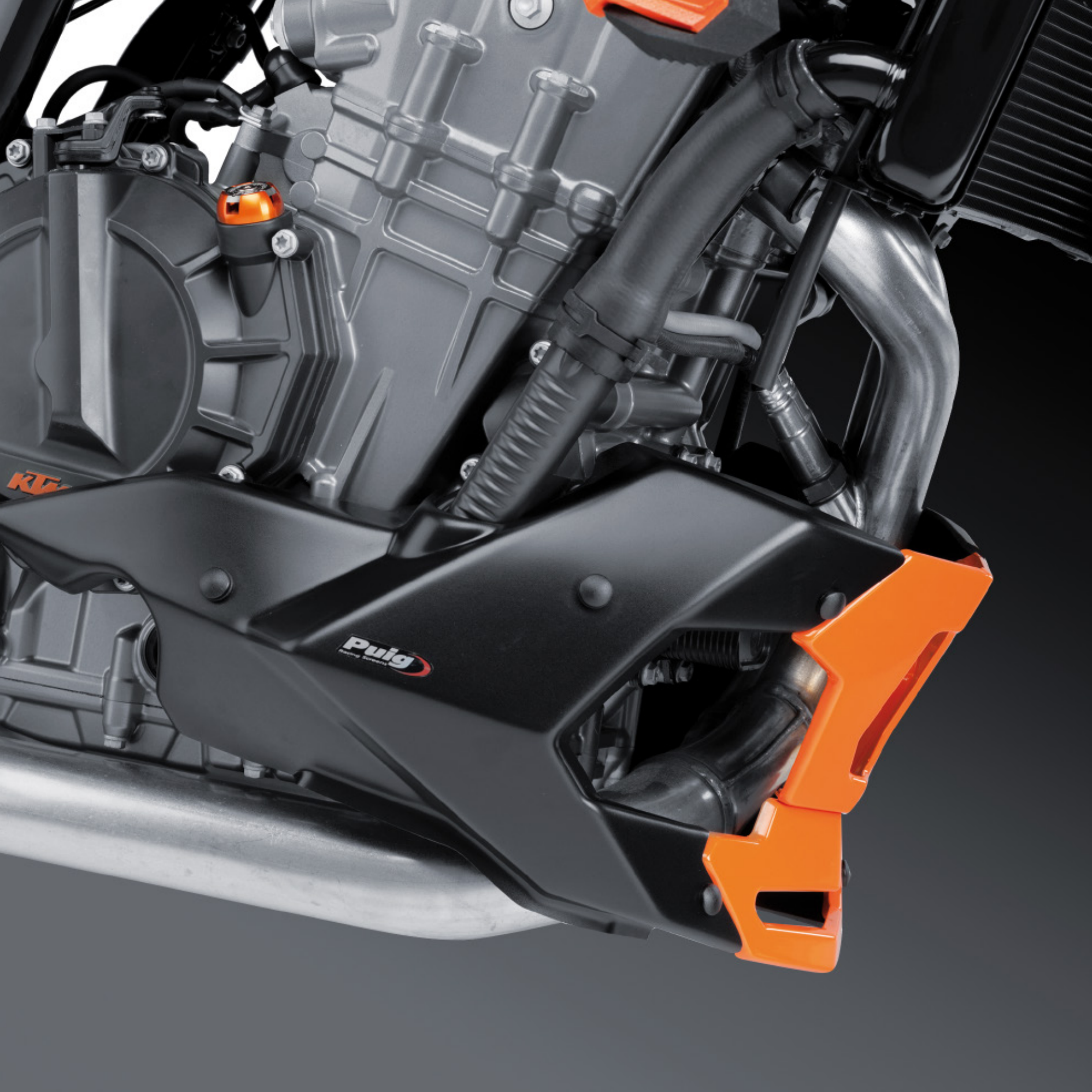

Puig
RACING SERVICES

RT



// EACH BIKE MODEL HAS ITS OWN DESIGN AND STYLE, TESTED IN OUR VIRTUAL WIND TUNNEL.

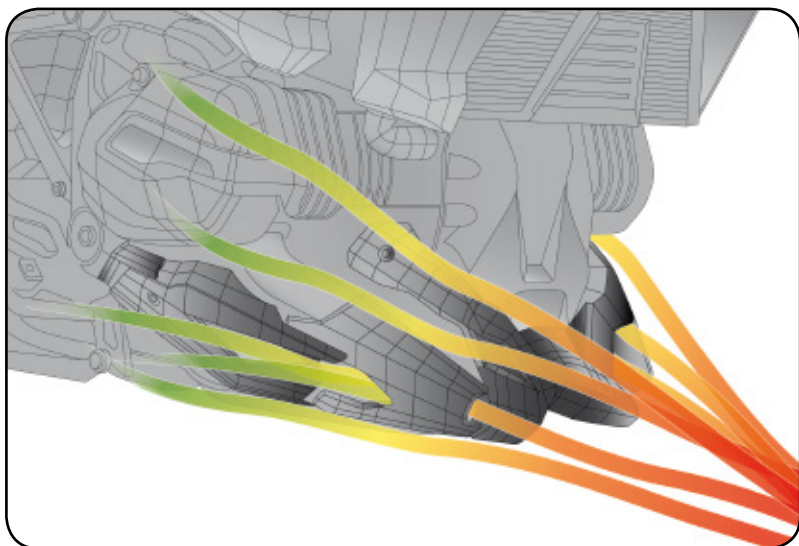

Improve stability and look.

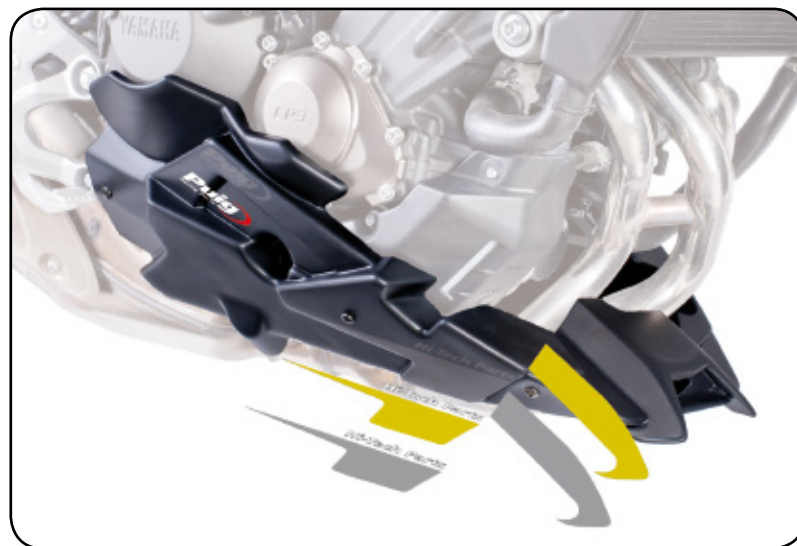

Adhesives to personalize at own taste according to bike models.

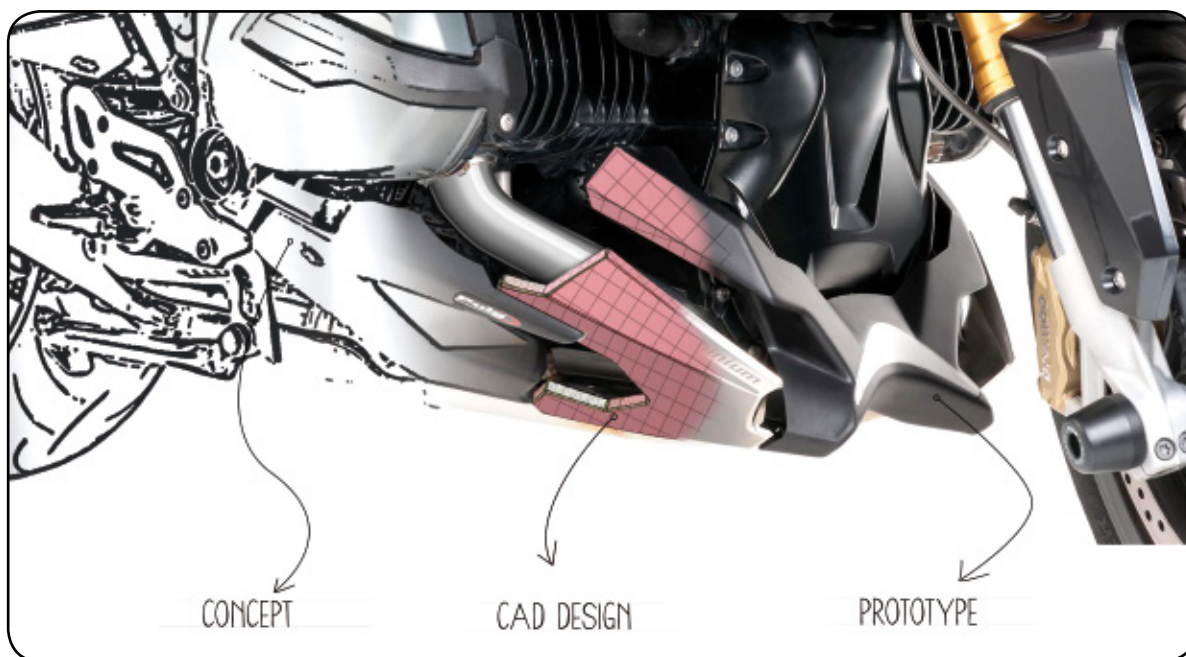

Multiple steps to a unic development.

MODEL	YEAR	ADHESIVE KIT	REFERENCE	Ⓙ	Ⓢ
BMW					
R1200 S	06' - 08'	NOT INCLUDED	4420	(*)	
R1200 R	15' - 18'	INCLUDED	7690	(*)	(*)
R1200 RS	15' - 18'	INCLUDED	7690	(*)	(*)
DUCATI					
MONSTER 1100	09' - 10'	INCLUDED	4955	(*)	(*)
HONDA					
CB600F HORNET	07' - 15'	INCLUDED	4413	(*)	(*)
CB650F	14' - 18'	INCLUDED	7021	(*)	(*)
CB1000R	08' - 16'	INCLUDED	4696	(*)	(*)
CBF500	04' - 07'	NOT INCLUDED	4000	(*)	(*)
CBF1000F	10' - 16'	NOT INCLUDED	5279	(*)	(*)
NT700V DEAUVILLE	06' - 12'	NOT INCLUDED	4132	(*)	
CB1000R NEO SPORTS CAFE	18'	INCLUDED	9746	(*)	(*)
KAWASAKI					
Z650	17' - 18'	INCLUDED	9589	(*)	(*)
Z750	07' - 12'	INCLUDED	4525	(*)	(*)
Z750R	11' - 12'	INCLUDED	4525	(*)	(*)
Z800	13' - 16'	INCLUDED	6507	(*)	(*)
Z800E	13' - 16'	INCLUDED	6507	(*)	(*)
Z900	17' - 18'	INCLUDED	9703	(*)	(*)
Z1000	07' - 09'	INCLUDED	4525	(*)	(*)
KTM					
790 DUKE	18'	INCLUDED	9669	(*)	(*)
1290 SUPERDUKE R	14' - 18'	INCLUDED	7573	(*)	(*)
1290 SUPERDUKE R FOR AKRAPOVIC EXHAUST	14' - 18'	INCLUDED	7573	(*)	(*)
1290 SUPERDUKE GT	16' - 18'	INCLUDED	7573	(*)	(*)
SUZUKI					
DL650 V-STROM	04' - 11'	INCLUDED	8559	(*)	(*)
DL650 V-STROM	12' - 18'	INCLUDED	5896	(*)	(*)
DL650XT V-STROM	15' - 18'	INCLUDED	5896	(*)	(*)
DL1000 V-STROM	14' - 16'	INCLUDED	7231	(*)	(*)
GS500	01' - 07'	NOT INCLUDED	3997		(*)
GSF600 BANDIT	00' - 04'	INCLUDED	1689	(*)	(*)
GSF600S BANDIT	00' - 04'	INCLUDED	1689	(*)	(*)
GSF650 BANDIT	05' - 06'	INCLUDED	1689	(*)	(*)
GSF650 BANDIT	07' - 11'	INCLUDED	4415		(*)
GSF650S BANDIT	05' - 06'	INCLUDED	1689	(*)	(*)
GSF650S BANDIT	07' - 14'	INCLUDED	4415		(*)
GSF1250 BANDIT	07' - 13'	INCLUDED	4415		(*)
GSF1250S BANDIT	07' - 16'	INCLUDED	4415		(*)

MODEL	YEAR	ADHESIVE KIT	REFERENCE	J	C
GSR750	11' - 16'	INCLUDED	5682	(*)	(*)
SFV650 GLADIUS	09' - 15'	INCLUDED	4954	(*)	(*)
SV650	99' - 02'	INCLUDED	8559	(*)	(*)
SV650/S	03' - 08'	INCLUDED	8559	(*)	(*)
SV650S	03' - 08'	INCLUDED	1633	(*)	(*)
SV650	16' - 18'	INCLUDED	8559	(*)	(*)
SV650X	18'	INCLUDED	8559	(*)	(*)
TRIUMPH					
STREET TRIPLE	07' - 12'	NOT INCLUDED	4702		(*)
STREET TRIPLE R	09' - 12'	NOT INCLUDED	4702		(*)
YAMAHA					
FZ1/FAZER	06' - 15'	NOT INCLUDED	4135	(*)	(*)
MT-07 - WITH ORIGINAL EXHAUST	14' - 18'	INCLUDED	7022	(*)	(*)
MT-07 - WITH AKRAPOVIC EXHAUST	14' - 18'	INCLUDED	7022	(*)	(*)
MT-07 TRACER - WITH ORIGINAL EXHAUST	16' - 18'	INCLUDED	7022	(*)	(*)
MT-07 TRACER - WITH AKRAPOVIC EXHAUST	16' - 18'	INCLUDED	7022	(*)	(*)
MT-09 - WITH ORIGINAL EXHAUST	13' - 18'	INCLUDED	7692	(*)	(*)
MT-09 - WITH AKRAPOVIC EXHAUST	13' - 18'	INCLUDED	7540	(*)	(*)
MT-09 SP - WITH ORIGINAL EXHAUST	18'	INCLUDED	7692	(*)	(*)
MT-09 SP - WITH AKRAPOVIC EXHAUST	18'	INCLUDED	7540	(*)	(*)
MT-09 TRACER WITH ORIGINAL EXHAUST	15' - 18'	INCLUDED	7692	(*)	(*)
MT-09 TRACER WITH AKRAPOVIC EXHAUST	15' - 18'	INCLUDED	7540	(*)	(*)
MT-09 TRACER GT FOR ORIGINAL EXHAUST	18'	INCLUDED	7692	(*)	(*)
MT-09 TRACER GT FOR AKRAPOVIC EXHAUST	18'	INCLUDED	7540	(*)	(*)
MT-10	16' - 18'	INCLUDED	8560	(*)	(*)
MT-10 SP	17' - 18'	INCLUDED	8560	(*)	(*)



J
Matt Black



C
Carbon Look

(*) Check price with your distributor.

ATTENTION: Previously verify any interference between our product and any other accessory (OEM or aftermarket) already installed on the motorcycle.

IMPORTANT: Indicate code color after part#. Example: 0973A.



Developed following MotoGP's evolution, Puig brings you the latest aerodynamic innovations coming from racing, which add notable improvements in the performance and rideability of your motorcycle.



Aerodynamic tests supplied along most of our spoilers.



N
Black



SPOILERS
COLORS

Depending on the motorcycle's model, we provide different color spoilers.



// DOWNFORCE SPOILERS

Developed in collaboration with KRT team on several tracks from SBK championship. The "downforce" effect improves braking, the anti-wheelie and anti-shimmie on straights. Moreover, it provides more stability when changing directions.

MODEL	YEAR	REF.	N
BMW			
S1000RR	15' - 18'	9767	(*)
HONDA			
CBR1000RR FIREBLADE/SP/SP2	17' - 18'	9729	(*)
KAWASAKI			
ZX-10R	16' - 18'	9882	(*)
ZX-10RR	17' - 18'	9882	(*)
ZX-10R SE	18'	9882	(*)
SUZUKI			
GSX-R1000/R	17' - 18'	9738	(*)
YAMAHA			
YZF-R1	15' - 18'	9766	(*)
YZF-R1 M	17' - 18'	9766	(*)
YZF-R6	17' - 18'	1946	(*)

(*) Check price with your distributor.

IMPORTANT: Indicate code color after part#. Example: 0973A.



68

PUP'S

ZELER

/// SIDE PANELS

HI-TECH PARTS | TECHNICAL SECTION

2019
MODELS:
www.puig.tv

139



MATERIAL:
Aluminium



MATERIAL:
ABS

// SIDE PANELS

MODEL	YEAR	REF.	J	C	U
BMW					
F750 GS	18'	9791	(*)		
F850 GS	18'	9791	(*)		
R1200 R	15' - 18'	7693	(*)	(*)	
R1200 RS	15' - 18'	7693	(*)	(*)	
R1200 GS	13' - 18'	6805	(*)		(*)
R1200GS EXCLUSIVE	17' - 18'	6805	(*)		(*)
R1200GS RALLYE	17' - 18'	6805	(*)		(*)
R1200 GS ADVENTURE	14' - 18'	7518	(*)		(*)
R1250GS	18'	6805	(*)		(*)
R1200 RT	05' - 13'	6367	(*)		(*)
KTM					
1050 ADVENTURE	15' - 16'	7513	(*)		
1090 ADVENTURE/R	17' - 18'	7513	(*)		
1190 ADVENTURE/R	13' - 16'	7513	(*)		
1290 SUPER ADVENTURE	15' - 16'	7513	(*)		
1290 SUPER ADVENTURE R/S	17' - 18'	7513	(*)		
1290 SUPER ADVENTURE T	17'	7513	(*)		
YAMAHA					
MT-09	13' - 18'	7612	(*)	(*)	
XT1200Z SUPER TÉNÉRÉ	10' - 18'	6804	(*)		
SPARES					
SIDE PANELS MT-09		9233	(*)	(*)	
SIDE PANELS R1200GS		9234	(*)		



CLEAN

Protect the rider and motorcycle from dirt on all type of roads.



DESIGN

Covers empty areas of the motorcycles.



U
Grey

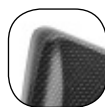

C
Carbon Look



J
Matt Black



P
Aluminium

(*) Check price with your distributor.

IMPORTANT: Indicate code color after part#. Example: 0973A.

// RETRO SIDE PANELS

MODEL	YEAR	REF.	J	C	P
BMW					
R NINE T (1)	14' - 18'	9590			(*)
R NINE T SCRAMBLER (1)	16' - 18'	9590			(*)
R NINE T PURE (1)	17' - 18'	9590			(*)
R NINE T RACER (1)	17' - 18'	9590			(*)
R NINE T URBAN G/S (1)	17' - 18'	9590			(*)
DUCATI					
SCRAMBLER ICON/CLASSIC/FULL THROTTLE (2)	15' - 18'	9179	(*)	(*)	
SCRAMBLER SIXTY2 (2)	16' - 18'	9179	(*)	(*)	
SCRAMBLER URBAN ENDURO (2)	15' - 16'	9179	(*)	(*)	
SCRAMBLER FLAT TRACK PRO (2)	16'	9179	(*)	(*)	
SCRAMBLER DESERT SLED (2)	17' - 18'	9179	(*)	(*)	
SCRAMBLER CAFE RACER (2)	17' - 18'	9179	(*)	(*)	
HONDA					
CB1100RS/EX	17' - 18'				CHECK WEB
YAMAHA					
XSR700 (2)	16' - 18'	8562 (#)	(*)	(*)	
XSR900 (2)	16' - 18'	8563 (#)	(*)	(*)	
UNIVERSAL					
UNIVERSAL SIDE PANELS WITHOUT SUPPORTS		9232	(*)	(*)	
ALUMINIUM SIDE PANELS WITHOUT SUPPORTS		9599			(*)

(#) ADHESIVE KIT INCLUDED.



YAMAHA

Puig
Hi-Tech parts

Puig
Hi-Tech parts



PROTECTION

Protects the rider from inclement weather.

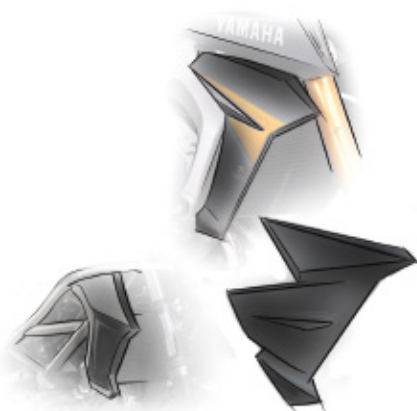

They cover the radiator's side edges and provide a continuous air flow around the rider's legs.

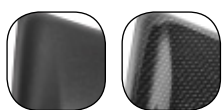

J
Matt Black

C
Carbon Look

MODEL	YEAR	ADHESIVE KIT	REF.	J	C
BMW					
R1200 R	15' - 18'	INCLUDED	7694	(*)	(*)
SUZUKI					
SV650	16' - 18'	INCLUDED	8564	(*)	(*)
YAMAHA					
MT-09	13' - 16'	INCLUDED	6880	(*)	(*)
MT-09	17' - 18'	INCLUDED	9378	(*)	(*)
MT-09 SP	18'	INCLUDED	9378	(*)	(*)
MT-07	14' - 17'	INCLUDED	7561	(*)	(*)
MT-07	18'	INCLUDED	9730	(*)	(*)

(*) Check price with your distributor.

IMPORTANT: Indicate code color after part#. Example: 0973A.

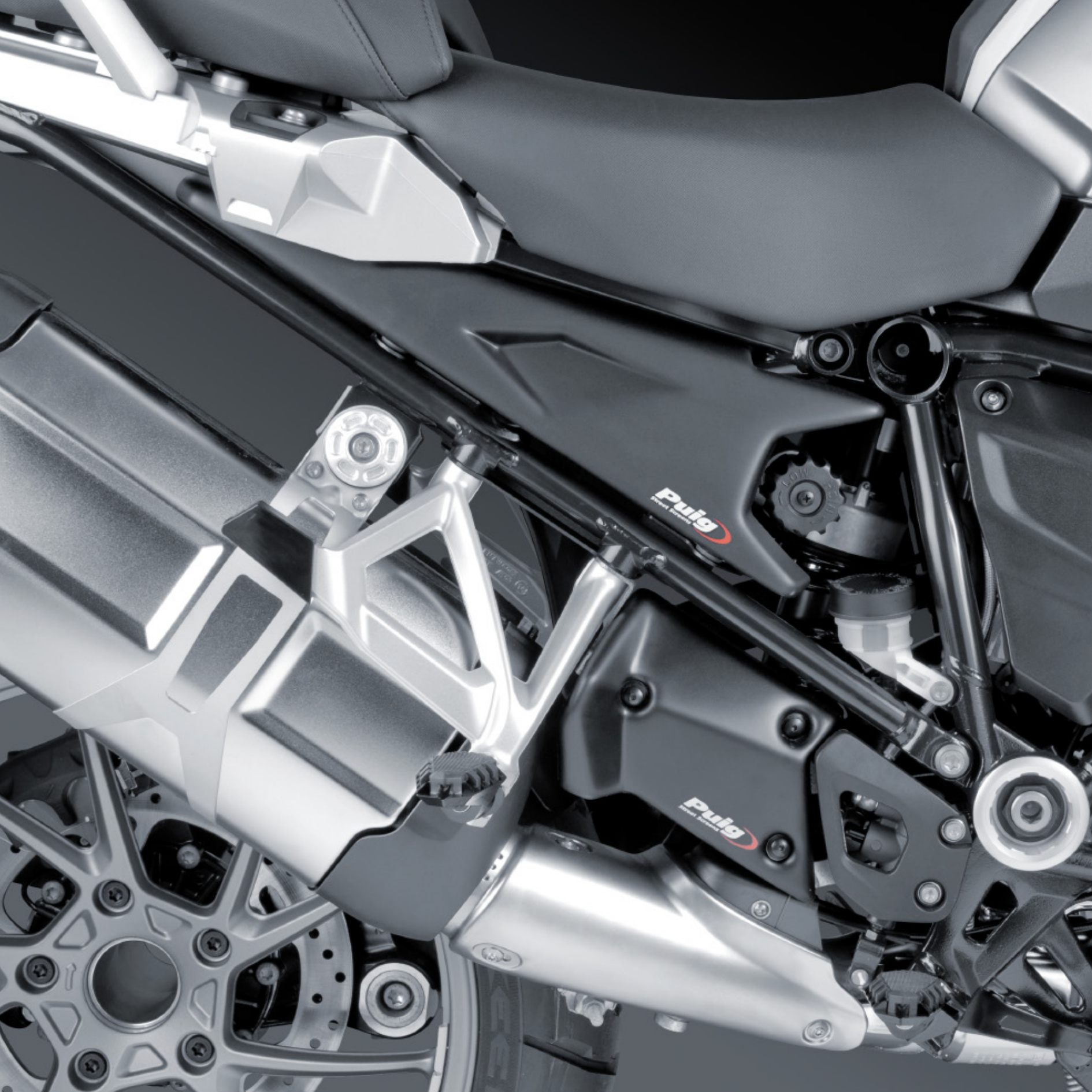



// REAR DEFLECTORS

MODEL	YEAR	REF.	J	C	U
BMW					
R1200 GS	04' - 12'	6802	(*)	(*)	(*)
R1200 GS	13' - 18'	6869	(*)	(*)	(*)
R1200GS EXCLUSIVE	17' - 18'	6869	(*)	(*)	(*)
R1200GS RALLYE	17' - 18'	6869	(*)	(*)	(*)
R1200 GS ADVENTURE	06' - 13'	6802	(*)	(*)	(*)
R1200 GS ADVENTURE	14' - 18'	6869	(*)	(*)	(*)
R1250GS	18'	6869	(*)	(*)	(*)
R1200 RT	14' - 17'	7529	(*)		

// REAR BRAKE TANK COVER

MODEL	YEAR	REF.	J	C
YAMAHA				
MT-07	14' - 18'	7578	(*)	(*)
MT-09	13' - 18'	7578	(*)	(*)
MT-09 SP	18'	7578	(*)	(*)
MT-07 TRACER	16' - 18'	7578	(*)	(*)
MT-09 TRACER	15' - 18'	8542	(*)	(*)



// BACKSHELL SPEEDOMETER

MODEL	YEAR	REF.	J	C
YAMAHA				
MT-09	13' - 16'	7515	(*)	(*)

// INTAKE COVERS

MODEL	YEAR	REF.	J	C
BMW				
R1200 R	15' - 18'	8105	(*)	(*)
R1200 GS	13' - 18'	9175	(*)	
R1200GS EXCLUSIVE	17' - 18'	9175	(*)	
R1200GS RALLYE	17' - 18'	9175	(*)	
R1250GS	18'	9175	(*)	

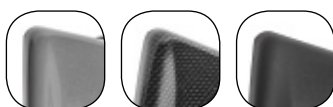

U Grey
C Carbon Look
J Matt Black

(*) Check price with your distributor.

IMPORTANT: Indicate code color after part#. Example: 0973A.

COVER - DEFLECTORS

HI-TECH PARTS

2019
MODELS:
www.puig.tv



// REAR LUGGAGE SUPPORT COVERS

MODEL	YEAR	REF.	J	C
YAMAHA				
MT-09 TRACER	15' - 17'	8089	(*)	(*)

// FRONTAL DEFLECTORS SCREENS

MODEL	YEAR	REF.	W	H	F	N
DUCATI						
MULTISTRADA 950	17' - 18'	CHECK WEB				
YAMAHA						
MT-09 TRACER	15' - 17'	9225			(*)	
MT-07 TRACER	16' - 18'	9226			(*)	



ALUMINIUM BASE

// FRONT DEFLECTOR

MODEL	YEAR	REF.	J	C
YAMAHA				
MT-09 TRACER	15' - 17'	8090	(*)	(*)

// EXHAUST PROTECTOR - DEFLECTOR

MODEL	YEAR	REF.	P
BMW			
R1200 RT	14' - 18'	8546	(*)



C Carbon Look J Matt Black P Aluminium N Black W Transparent H Smoke F Dark Smoke

(*) Check price with your distributor.

IMPORTANT: Indicate code color after part#. Example: 0973A.



// REAR HANDLES COVERS

MODEL	YEAR	REF.	J
BMW			
R1200 R	15' - 18'	9083	(*)
R1200 RS	15' - 18'	9083	(*)



// FRONTAL EXTENSION FENDER

MODEL	YEAR	REF.	J
BMW			
R1200GS	13' - 16'	9174	(*)
R1200GS	17' - 18'	9473	(*)
R1200GS EXCLUSIVE	17' - 18'	9473	(*)
R1200GS RALLYE	17' - 18'	9473	(*)
R1250GS	18'	9473	(*)



ALUMINIUM BASE

// HANDLEBAR REINFORCEMENT

MODEL	YEAR	REF.	R	A	N	P
YAMAHA						
MT-07 TRACER	16' - 18'	9256				(*)



N Black
J Matt Black
P Aluminium
R Red
A Blue

(*) Check price with your distributor.

IMPORTANT: Indicate code color after part#. Example: 0973A.



// UPPER DEFLECTORS

MODEL	YEAR	REF.	W H F
BMW			
F750GS	18'	9847	(*)
F850GS	18'	9847	(*)
R1200GS	13' - 18'	9847	(*)
R1200GS EXCLUSIVE	17' - 18'	9847	(*)
R1200GS RALLYE	17' - 18'	9847	(*)
R1250GS	18'	9847	(*)
KTM			
1090 ADVENTURE/R	17' - 18'	9623	(*)
1290 SUPER ADVENTURE R/S	17' - 18'	9623	(*)
1290 SUPER ADVENTURE T	17'	9623	(*)

// LOWER DEFLECTORS

MODEL	YEAR	REF.	W H F
BMW			
R1200GS	13' - 18'	9848	(*)
R1200GS EXCLUSIVE	17' - 18'	9848	(*)
R1200GS RALLYE	17' - 18'	9848	(*)
R1250GS	18'	9848	(*)



W Transparent
H Smoke
F Dark Smoke

(*) Check price with your distributor.

IMPORTANT: Indicate code color after part#. Example: 0973A.



// HANDLEBAR DEFLECTORS

MODEL	YEAR	REF.	W	H	F
BMW					
F750GS	18'	1319			(*)
F850GS	18'	1319			(*)
R1200GS	13' - 18'	9397			(*)
R1200GS EXCLUSIVE	17' - 18'	9397			(*)
R1200GS RALLYE	17' - 18'	9397			(*)
R1250GS	18'	9397			(*)
S1000 XR	15' - 18'	9397			(*)



// FRONTAL COVER

MODEL	YEAR	REF.	F	J
YAMAHA				
MT-09	17' - 18'	9507	(*)	
MT-09 SP	18'	9507	(*)	
MT-07	18' - 19'	1439		(*)



J Matt Black W Transparent H Smoke F Dark Smoke

(*) Check price with your distributor.

IMPORTANT: Indicate code color after part#. Example: 0973A.



CHASSIS CAP COVERS

HI-TECH PARTS | TECHNICAL SECTION

149

NEW!

MODEL	YEAR	REF.	N
BMW			
F750GS	18'	0096	(*)
F850GS	18'	0096	(*)
R1200GS	13' - 18'	9332	(*)
R1200GS EXCLUSIVE	17' - 18'	9332	(*)
R1200GS RALLYE	17' - 18'	9332	(*)
R1200GS ADVENTURE	14' - 18'	9332	(*)
R1200R	15' - 18'	9333	(*)
R1200RS	15' - 18'	9333	(*)
R1200RT	14' - 18'	0327	(*)
R NINE T	17' - 18'	9664	(*)
R NINE T PURE	17' - 18'	9664	(*)
R NINE T RACER	17' - 18'	9664	(*)
R NINE T URBAN G/S	17' - 18'	9664	(*)
R NINE T SCRAMBLER	17' - 18'	9664	(*)
DUCATI			
DIAVEL	11' - 15'	9611	(*)
X DIAVEL/S	16' - 18'	9705	(*)
899 PANIGALE	14' - 15'	9631	(*)
959 PANIGALE	16' - 18'	9631	(*)
MONSTER 797	17' - 18'	9632	(*)
MONSTER 821	14' - 16'	9633	(*)
MONSTER 1200/S	14' - 16'	9633	(*)
HYPERMOTARD 821/SP	13' - 15'	9634	(*)
HYPERMOTARD 939/SP	16'	9634	(*)
HYPERSTRADA	13' - 15'	9634	(*)
HYPERSTRADA 939/SP	16'	9634	(*)
MULTISTRADA 1200/ S	10' - 14'	9635	(*)
MULTISTRADA 1200/S	15' - 17'	9636	(*)
SCRAMBLER ICON/CLASSIC/FULL THROTTLE	15' - 18'	9632	(*)
SCRAMBLER SIXTY2	16' - 18'	9632	(*)
SCRAMBLER URBAN ENDURO	15' - 16'	9632	(*)
SCRAMBLER FLAT TRACK PRO	16'	9632	(*)
SCRAMBLER DESERT SLED	17' - 18'	9632	(*)
SCRAMBLER CAFE RACER	17' - 18'	9632	(*)
HONDA			
CB125R NEO SPORTS CAFE	18'	9801	(*)
CB300R NEO SPORTS CAFE	18'	9809	(*)
CB1000R NEO SPORTS CAFE	18'	9809	(*)
KAWASAKI			
Z650	17' - 18'	9637	(*)

MODEL	YEAR	REF.	N
NINJA 400	18'	9796	(*)
NINJA 650	17' - 18'	9637	(*)
Z900	17' - 18'	9777	(*)
Z900RS	18'	9778	(*)
KTM			
1050 ADVENTURE	15' - 16'	9787	(*)
1090 ADVENTURE /R	17' - 18'	9787	(*)
1190 ADVENTURE/R	13' - 16'	9787	(*)
1290 SUPER ADVENTURE	15' - 16'	9787	(*)
1290 SUPER ADVENTURE R	17' - 18'	9787	(*)
1290 SUPER ADVENTURE S	17' - 18'	9787	(*)
1290 SUPER ADVENTURE T	17' - 18'	9787	(*)
1290 SUPERDUKE R	14' - 16'	9787	(*)
1290 SUPERDUKE R	17' - 18'	9787	(*)
1290 SUPERDUKE GT	16' - 17'	9787	(*)
YAMAHA			
MT-07	14' - 17'	9638	(*)
MT-07 TRACER	16' - 18'	9638	(*)
XSR700	16' - 18'	9638	(*)

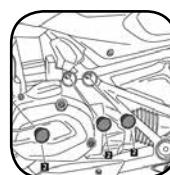

2 FUNCTIONALITIES

Cover hollow areas of the chassis and improves look of the bike.



N
Black

(*) Check price with your distributor.

IMPORTANT: Indicate code color after part#. Example: 0973A.

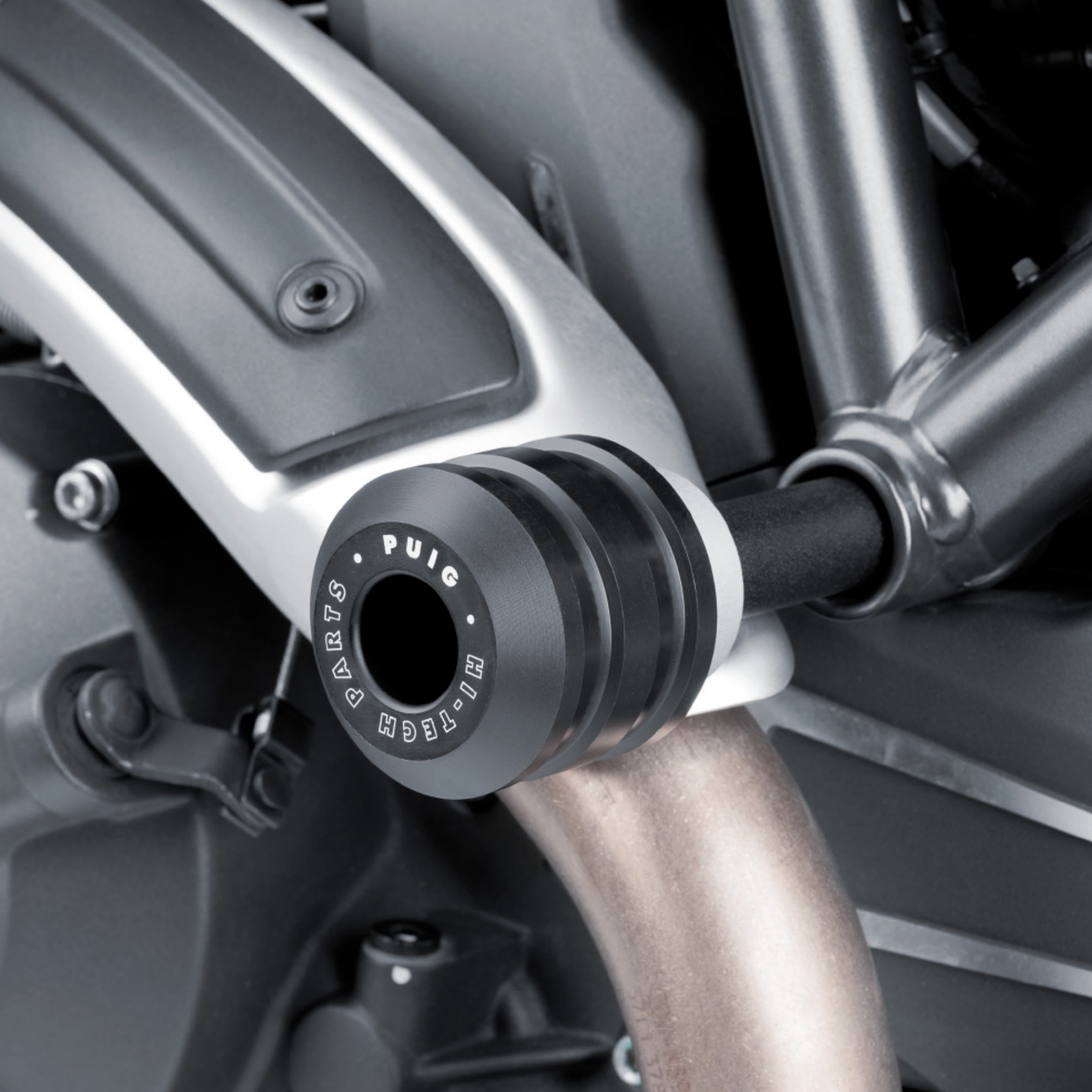

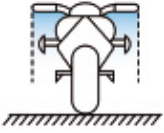

DESIGN

Sliders do not stand out from handlebar and touch after the footpegs.



COMPLETE PROTECTION

Protect engine and chassis.

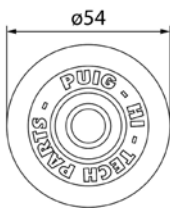

DIMENSIONS



N
Black

SPARES	REFERENCE	N
NYLON PUCK FOR M10 BOLT	9562	(*)
NYLON PUCK FOR M12 BOLT	9563	(*)

FOR SPECIFIC MODELS SEE PAGE 158



FRAME SLIDERS R19 MODEL

HI-TECH PARTS | TECHNICAL SECTION

153

NEW!

BODY

Nylon pucks in black colour.



RUBBER

Protects rider's knee from possible hits while getting on the bike. Supplied in grey color.

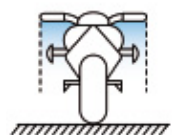

DESIGN

Sliders do not stand out from handlebar and touch after the footpegs.



COMPLETE PROTECTION

Protect engine and chassis.

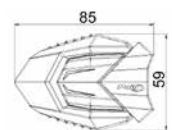

DIMENSIONS

// RUBBER ENDS AVAILABLE IN VARIOUS COLORS

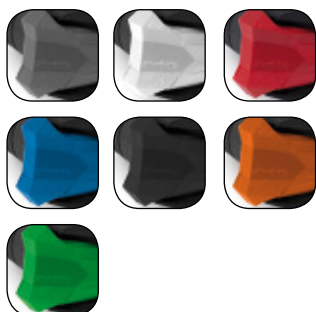

SPARES RUBBERS	REF.	U	B	R	V	A	N	T
RUBBER END PROTECTOR R19 BY PAIR	3148							(*)

SPARES PUCKS	REF.	A	N
NYLON PUCKS + RUBBER END C/GREY BY PAIR MOD. R19 OF 85 mm. FOR SCREW M10	3149		(*)
NYLON PUCKS + RUBBER END C/GREY BY PAIR MOD. R19 OF 85 mm. FOR SCREW M12	3150		(*)
NYLON PUCKS + RUBBER END C/GREY BY PAIR MOD. R19 OF 50 mm. FOR SCREW M10	3151		(*)
NYLON PUCKS + RUBBER END C/GREY BY PAIR MOD. R19 OF 50 mm. FOR SCREW M12	3152	(*)	(*)

SPARE PUCKS VINTAGE	REFERENCE	N
NYLON PUCKS VINTAGE FOR SCREWS M10 (COMPATIBLE WITH R19 SLIDERS)	3153	(*)
NYLON PUCKS VINTAGE FOR SCREWS M12 (COMPATIBLE WITH R19 SLIDERS)	3154	(*)

(*) Check price with your distributor.

FOR SPECIFIC MODELS CHECK WEB



PUIG HI-TECH PARTE

PUIG HI-TECH PARTE

BODY

Nylon pucks in black colour.



RUBBER

Protects rider's knee from possible hits while getting on the bike.
Supplied in grey color.

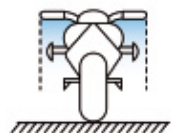

DESIGN

Sliders do not stand out from handlebar and touch after the footpegs.

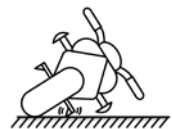

COMPLETE PROTECTION

Protect engine and chassis.

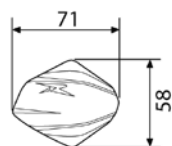

DIMENSIONS

// RUBBER ENDS AVAILABLE IN VARIOUS COLORS



SPARE RUBBERS	REF.	U	B	R	V	A	N
RUBBER END PROTECTOR R12 BY PAIR	6378						(*)

SPARE PUCKS	REF.	A	B	V	N
NYLON PUCKS + RUBBER END C/GREY BY PAIR MOD. R12 OF 85 mm. FOR SCREW M10	6379				(*)
NYLON PUCKS + RUBBER END C/GREY BY PAIR MOD. R12 OF 85 mm. FOR SCREW M12	6381				(*)
NYLON PUCKS + RUBBER END C/GREY BY PAIR MOD. R12 OF 50 mm. FOR SCREW M10	6380				(*)
NYLON PUCKS + RUBBER END C/GREY BY PAIR MOD. R12 OF 50 mm. FOR SCREW M12	6382	(*)			(*)

SPARE PUCKS VINTAGE	REFERENCE	N
NYLON PUCKS VINTAGE FOR SCREWS M10 (COMPATIBLE WITH R12 SLIDERS)	9562	(*)
NYLON PUCKS VINTAGE FOR SCREWS M12 (COMPATIBLE WITH R12 SLIDERS)	9563	(*)

FOR SPECIFIC MODELS SEE PAGE 158



BODY

Nylon pucks in black colour.

RUBBER END

Available in different colors.



Avoid knee injuries.



DESIGN

Sliders do not stand out from handlebar and touch after the footpegs.

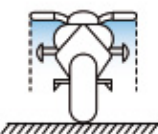

COMPLETE PROTECTION

Protect engine and chassis.

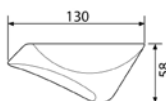

DIMENSIONS



SPARES	REF.	A	P	R	V	N
RUBBER END BY PAIR C/BLUE	5533			(*)		
RUBBER END BY PAIR C/GREY	5533			(*)		
RUBBER END BY PAIR C/RED	5533			(*)		
RUBBER END BY PAIR C/GREEN	5533			(*)		
PLASTIC CAPS WITH LOGO BY PAIR C/BLACK	5534					(*)
NYLON PUCKS BY PAIR C/BLACK	5536					(*)

FRAME SLIDERS

HI-TECH PARTS | TYPE OF FRAME SLIDERS:

2019
MODELS:
www.puig.tv



FRAME SLIDER VINTAGE

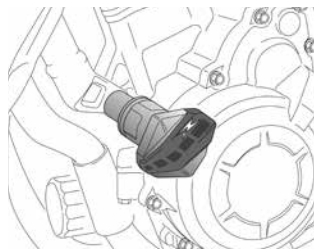

FRAME SLIDER R12 / R19

Spares for model R12 will be
manufactured with model R19.
Check website.

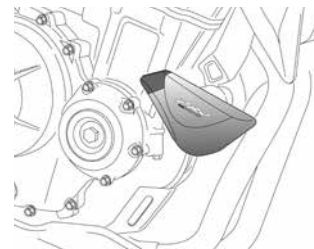

FRAME SLIDER PRO

MODEL	YEAR	TYPE OF FRAME SLIDER	REFERENCE	N
APRILIA				
DORSODURO 750	08' - 16'	R12	4706	(*)
DORSODURO 900	17' - 18'	R12	4706	(*)
DORSODURO 1200	11' - 16'	R12	4706	(*)
MANA 850	08' - 12'	R12	5891	(*)
RSV4	09' - 12'	PRO	5692	(*)
RSV4	09' - 12'	R12	5578	(*)
RSV4 FACTORY	13' - 14'	PRO	5692	(*)
RSV4 R	13' - 14'	PRO	5692	(*)
RSV4 RF	15' - 16'	PRO	5692	(*)
RSV4 RR	15' - 16'	PRO	5692	(*)
SHIVER 750	07' - 16'	R12	4706	(*)
SHIVER GT	08' - 16'	R12	4706	(*)
SHIVER 900	17' - 18'	R12	4706	(*)
TUONO V4R	11' - 14'	PRO	5692	(*)
TUONO V4 1100 RR	15' - 16'	PRO	5692	(*)
TUONO V4 1100 FACTORY	15' - 16'	PRO	5692	(*)
BENELLI				
BN 302	14' - 18'	R12	8106	(*)
LEONCINO 500	16' - 18'	R12	9693	(*)
BMW				
F750GS	18'	R12	9779	(*)
F850GS	18'	R12	9779	(*)
F800 R	09' - 14'	R12	4185	(*)
F800 R	15' - 18'	R12	7707	(*)
F800 R	15' - 18'	PRO	7699	(*)
F800 S	06' - 11'	R12	4185	(*)
G310 R	16' - 18'	R12	8566	(*)
S1000 R	14' - 16'	R12	7061	(*)
S1000 R	17' - 18'	R12	9488	(*)

MODEL	YEAR	TYPE OF FRAME SLIDER	REFERENCE	N
S1000 RR	09' - 11'	R12	5579	(*)
S1000 RR	09' - 11'	PRO	5282	(*)
S1000 RR	12' - 14'	R12	6060	(*)
S1000 RR	12' - 14'	PRO	6070	(*)
S1000 RR	15' - 18'	R12	5579	(*)
S1000 RR	15' - 18'	PRO	5282	(*)
S1000 XR	15' - 18'	R12	7709	(*)
DUCATI				
DIAVEL	11' - 14'	R12	8440	(*)
DIAVEL	15' - 18'	R12	8440	(*)
X DIAVEL/S	16' - 18'	R12	8567	(*)
HYPERMOTARD 821/SP	13' - 15'	R12	6557	(*)
HYPERMOTARD 939/SP	16' - 18'	R12	6557	(*)
HYPERSTRADA 939	16' - 17'	R12	6557	(*)
MONSTER 620	02' - 06'	R12	1850	(*)
MONSTER 695	06' - 07'	R12	1850	(*)
MONSTER 696	08' - 14'	R12	4705	(*)
MONSTER 796	10' - 14'	R12	4705	(*)
MONSTER 797	17' - 18'	R12	9497	(*)
MONSTER 800	03' - 04'	R12	1850	(*)
MONSTER 821	14' - 18'	R12	7062	(*)
MONSTER 1000	02' - 05'	R12	1850	(*)
MONSTER 1100/S	09' - 10'	R12	4705	(*)
MONSTER 1100 EVO	11' - 13'	R12	4705	(*)
MONSTER 1200/S	14' - 16'	R12	7062	(*)
MONSTER 1200/S	17' - 18'	R12	7062	(*)
MONSTER 1200 R	16' - 18'	R12	7062	(*)
MULTISTRADA 1200/S	10' - 14'	R12	5585	(*)
MULTISTRADA 1200/S	10' - 14'	PRO	5303	(*)
STREETFIGHTER 848	12' - 15'	R12	5585	(*)
STREETFIGHTER 848	12' - 15'	PRO	5303	(*)
STREETFIGHTER 1100	09' - 12'	R12	5585	(*)
STREETFIGHTER 1100	09' - 12'	PRO	5303	(*)
STREETFIGHTER 1100 S	09' - 13'	R12	5585	(*)
STREETFIGHTER 1100 S	09' - 13'	PRO	5303	(*)
SCRAMBLER ICON	15' - 18'	VINTAGE	8150	(*)
SCRAMBLER CLASSIC	15' - 18'	VINTAGE	8150	(*)
SCRAMBLER URBAN ENDURO	15' - 16'	VINTAGE	8150	(*)



VINTAGE

N
BlackPROT.
R12 / R19N
Black

PROT. PRO

N
Black

(*) Check price with your distributor.
(-) Supplied with holesaw to drill bodywork.

IMPORTANT: Indicate code color after part#. Example: 0973A.

FRAME SLIDERS

HI-TECH PARTS | TYPE OF FRAME SLIDERS:

2019
MODELS:
www.puig.tv



FRAME SLIDER VINTAGE

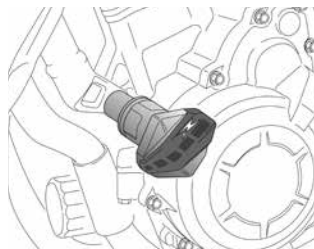

FRAME SLIDER R12 / R19

Spares for model R12 will be
manufactured with model R19.
Check website.

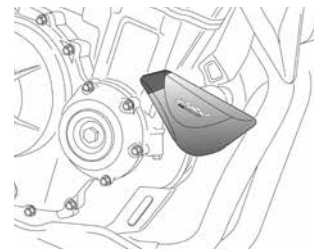

FRAME SLIDER PRO

MODEL	YEAR	TYPE OF FRAME SLIDER	REFERENCE	N
SCRAMBLER FULL THROTTLE	15' - 18'	VINTAGE	8150	(*)
SCRAMBLER SIXTY2	16' - 18'	VINTAGE	8150	(*)
SCRAMBLER FLAT TRACK PRO	16'	VINTAGE	8150	(*)
SCRAMBLER DESERT SLED	17' - 18'	VINTAGE	8150	(*)
SCRAMBLER CAFE RACER	17' - 18'	VINTAGE	8150	(*)
SCRAMBLER 1100	18'	VINTAGE	8150	(*)
SCRAMBLER 1100 SPORT	18'	VINTAGE	8150	(*)
SCRAMBLER 1100 SPECIAL	18'	VINTAGE	8150	(*)
HONDA				
CB125F	15' - 18'	R12	7931	(*)
CB125R NEO SPORTS CAFE	18'	R12	9654	(*)
CB300F	15' - 18'	R12	7932	(*)
CB300R NEO SPORTS CAFE	18'	R12	9757	(*)
CB500F	13' - 18'	PRO	6468	(*)
CB500F	13' - 18'	R12	6560	(*)
CB500X	13' - 18'	PRO	6468	(*)
CB500X	13' - 18'	R12	6560	(*)
CB600F HORNET	98' - 06'	R12	1851	(*)
CB600F HORNET	07' - 15'	R12	4423	(*)
CB650F	14' - 16'	R12	7057	(*)
CB650F	14' - 16'	PRO	7070	(*)
CB650F	17' - 18'	R12	9443	(*)
CB650F	17' - 18'	PRO	7070	(*)
CB1000R	08' - 16'	PRO	5283	(*)
CB1000R	08' - 16'	R12	4704	(*)
CB1000R NEO SPORTS CAFE	18'	R12	9753	(*)
CB1000R NEO SPORTS CAFE	18'	PRO	9754	P
CBF500	04' - 07'	R12	1854	(*)
CBF600	04' - 07'	R12	1853	(*)
CBF600/S	08' - 14'	PRO	5285	(*)

MODEL	YEAR	TYPE OF FRAME SLIDER	REFERENCE	N
CBF600/S	08' - 14'	R12	4423	(*)
CBR600F	99' - 07'	R12	1856	(*)
CBR650F	14' - 16'	R12	7056	(*)
CBR650F	17' - 18'	R12	7056	(*)
CBR500R	13' - 15'	PRO	6469	(*)
CBR500R	13' - 15'	R12	6559	(*)
CBR500R	16' - 18'	PRO	8575	(*)
CBR500R	16' - 18'	R12	8576	(*)
CBR600RR	03' - 06'	R12 (-)	1857	(*)
CBR600RR	07' - 08'	R12	4424	(*)
CBR600RR	13' - 15'	R12 (-)	6558	(*)
CBR1000RR FIREBLADE	04' - 05'	R12 (-)	1970	(*)
CBR1000RR FIREBLADE	06' - 07'	R12	4062	(*)
CBR1000RR FIREBLADE	08' - 11'	R12 (-)	4703	(*)
CROSSRUNNER	11' - 14'	R12	5695	(*)
NC700S/X	12' - 13'	PRO	6063	(*)
NC700S/X	12' - 13'	R12	6047	(*)
NC750S/X	14' - 18'	R12	6047	(*)
NC750S/X	14' - 18'	PRO	6063	(*)
VTR1000F FIRE STORM	97' - 07'	R12	3909	(*)
HYOSUNG				
GT650R	06' - 12'	R12	6402	(*)
KAWASAKI				
ER-6N	05' - 08'	R12	4069	(*)
ER-6N	09' - 11'	PRO	5288	(*)
ER-6N	09' - 11'	R12	4964	(*)
ER-6N	12' - 16'	PRO	6067	(*)
ER-6N	12' - 16'	R12	6054	(*)
ER-6F	09' - 11'	R12	4965	(*)
ER-6F	12' - 16'	PRO	6068	(*)
ER-6F	12' - 16'	R12	6055	(*)
KLV1000	04' - 05'	R12	1871	(*)
NINJA 250R	08' - 12'	R12	5170	(*)
NINJA 300	13' - 17'	R12	6562	(*)
NINJA 400	18'	R12	9628	(*)
NINJA 650	17' - 18'	R12	9466	(*)
NINJA 650	17' - 18'	PRO	9467	(*)
NINJA H2 SX	18'	R12	9708	(*)



VINTAGE

N
BlackPROT.
R12 / R19N
Black

PROT. PRO

N
Black

(*) Check price with your distributor.
(-) Supplied with holesaw to drill bodywork.

IMPORTANT: Indicate code color after part#. Example: 0973A.

FRAME SLIDERS

HI-TECH PARTS | TYPE OF FRAME SLIDERS:

2019
MODELS:
www.puig.tv



FRAME SLIDER VINTAGE

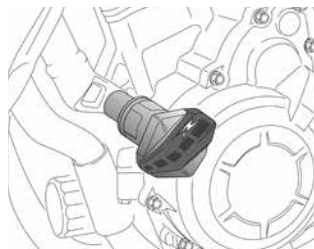

FRAME SLIDER R12 / R19

Spares for model R12 will be
manufactured with model R19.
Check website.

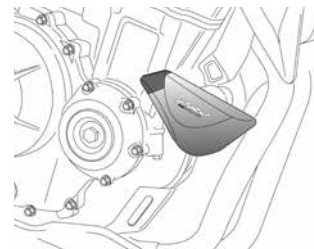

FRAME SLIDER PRO

MODEL	YEAR	TYPE OF FRAME SLIDER	REFERENCE	N
VERSYS 650	07' - 09'	R12	4430	(*)
VERSYS 650	10' - 14'	PRO	5289	(*)
VERSYS 650	15' - 18'	PRO	7702	(*)
VERSYS 650	15' - 18'	R12	7714	(*)
VERSYS 1000	12' - 18'	R12	6053	(*)
VERSYS 1000	15' - 18'	PRO	7071	(*)
Z250SL	15' - 16'	R12	7716	(*)
Z300	15' - 17'	R12	7717	(*)
Z650	17' - 18'	PRO	9354	(*)
Z650	17' - 18'	R12	9355	(*)
Z750	04' - 06'	R12	1860	(*)
Z750	07' - 12'	PRO	5290	(*)
Z750	07' - 12'	R12	4527	(*)
Z750S	05' - 06'	R12	1860	(*)
Z750R	11' - 12'	PRO	5290	(*)
Z750R	11' - 12'	R12	4527	(*)
Z800	13' - 16'	PRO	6471	(*)
Z800E	13' - 16'	PRO	6471	(*)
Z800	13' - 16'	R12	6563	(*)
Z800E	13' - 16'	R12	6563	(*)
Z900	17' - 18'	R12	9389	(*)
Z900	17' - 18'	PRO	9390	(*)
Z900RS	18'	VINTAGE	9598	(*)
Z1000	03' - 06'	R12	1860	(*)
Z1000	07' - 09'	R12	4527	(*)
Z1000	07' - 09'	PRO	5290	(*)
Z1000	14' - 18'	R12	7059	(*)
Z1000	14' - 18'	PRO	7071	(*)
Z1000R	17' - 18'	R12	7059	(*)
Z1000R	17' - 18'	PRO	7071	(*)

MODEL	YEAR	TYPE OF FRAME SLIDER	REFERENCE	N
Z1000SX	11' - 13'	PRO	5689	(*)
Z1000SX	11' - 13'	R12	5701	(*)
Z1000SX	14' - 16'	R12	5701	(*)
Z1000SX	14' - 16'	PRO	5689	(*)
Z1000SX	17' - 18'	R12	9399	(*)
Z1000SX	17' - 18'	PRO	9400	(*)
ZX-6R	05' - 06'	R12	3910	(*)
ZX-6R	07' - 08'	R12	4429	(*)
ZX-6R	09' - 16'	PRO	5629	(*)
ZX-6R 636	13' - 16'	PRO	6472	(*)
ZX-6R 636	13' - 16'	R12	6564	(*)
ZX-10R	11' - 18'	R12	5702	(*)
ZX-10R	11' - 18'	PRO	5690	(*)
ZX-10RR	17' - 18'	R12	5702	(*)
ZX-10RR	17' - 18'	PRO	5690	(*)
ZX-10R SE	18'	R12	5702	(*)
ZX-10R SE	18'	PRO	5690	(*)
ZZR1400	06' - 11'	R12	4070	(*)
ZZR1400	12' - 18'	R12	6056	(*)
KTM				
125 DUKE	11' - 16'	R12	5700	(*)
125 DUKE	17' - 18'	R12	6565	(*)
200 DUKE	12' - 15'	R12	5700	(*)
390 DUKE	13' - 18'	R12	6565	(*)
790 DUKE	18'	R12	9674	(*)
1290 SUPERDUKE GT	16' - 18'	R12	7063	(*)
1290 SUPERDUKE R	14' - 18'	R12	7063	(*)
MV AGUSTA				
BRUTALE 675	12' - 18'	R12	7065	(*)
BRUTALE 800/RR	13' - 16'	R12	7065	(*)
BRUTALE 800/RR	17' - 18'	R12	9853	(*)
BRUTALE DRAGSTER 800/RR	14' - 16'	R12	7065	(*)
BRUTALE DRAGSTER 800/RR	17' - 18'	R12	9853	(*)
RIVALE 800	13' - 18'	R12	7065	(*)
STRADALE 800	15' - 18'	R12	7065	(*)
TURISMO VELOCE 800	14' - 16'	R12	7065	(*)
TURISMO VELOCE 800	17' - 18'	R12	9853	(*)
TURISMO VELOCE 800 LUSO	14' - 16'	R12	7065	(*)



VINTAGE

N
BlackPROT.
R12 / R19N
Black

PROT. PRO

N
Black

(*) Check price with your distributor.
 (-) Supplied with holesaw to drill bodywork.

IMPORTANT: Indicate code color after part#. Example: 0973A.

FRAME SLIDERS

HI-TECH PARTS | TYPE OF FRAME SLIDERS:

2019
MODELS:
www.puig.tv



FRAME SLIDER VINTAGE

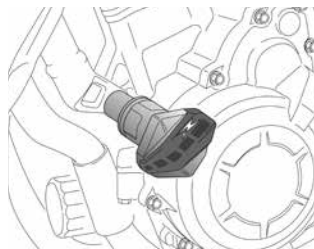

FRAME SLIDER R12 / R19

Spares for model R12 will be
manufactured with model R19.
Check website.

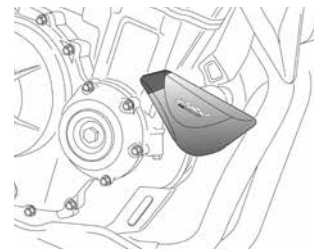

FRAME SLIDER PRO

MODEL	YEAR	TYPE OF FRAME SLIDER	REFERENCE	N
TURISMO VELOCE 800 LUSO	17' - 18'	R12	9853	(*)
SUZUKI				
B-KING	08' - 11'	R12	4651	(*)
DL250 V-STROM	17' - 18'	R12	6243	(*)
DL650 V-STROM	04' - 18'	R12	1870	(*)
DL650XT V-STROM	15' - 18'	R12	1870	(*)
DL1000 V-STROM	02' - 07'	R12	1871	(*)
DL1000 V-STROM	14' - 18'	R12	6569	(*)
DL1000XT V-STROM	17' - 18'	R12	6569	(*)
GS500	01' - 07'	R12	2017	(*)
GSF600 BANDIT	96' - 04'	R12	1869	(*)
GSF600S BANDIT	96' - 04'	R12	1869	(*)
GSF650 BANDIT	05' - 06'	R12	3918	(*)
GSF650 BANDIT	07' - 11'	R12	4428	(*)
GSF650S BANDIT	05' - 06'	R12	3918	(*)
GSF650S BANDIT	07' - 14'	R12	4428	(*)
GSF1200 BANDIT	96' - 05'	R12	1869	(*)
GSF1200S BANDIT	96' - 05'	R12	1869	(*)
GSF1250 BANDIT	07' - 13'	R12	4428	(*)
GSF1250S BANDIT	07' - 13'	R12	4428	(*)
GSR600	06' - 11'	PRO	5293	(*)
GSR600	06' - 11'	R12	4067	(*)
GSR750	11' - 16'	PRO	5687	(*)
GSR750	11' - 16'	R12	5698	(*)
GSX650F	08' - 16'	R12	4654	(*)
GSX-R600	01' - 03'	R12	1971	(*)
GSX-R600	04' - 05'	R12	1865	(*)
GSX-R600	06' - 07'	R12	4066	(*)
GSX-R600	08' - 10'	R12	4652	(*)
GSX-R600	08' - 10'	PRO	5294	(*)

MODEL	YEAR	TYPE OF FRAME SLIDER	REFERENCE	N
GSX-R600	11' - 16'	R12	5697	(*)
GSX-R600	11' - 16'	PRO	5686	(*)
GSX-R750	00' - 03'	R12	1971	(*)
GSX-R750	04' - 05'	R12	1865	(*)
GSX-R750	06' - 07'	R12	4066	(*)
GSX-R750	08' - 10'	R12	4652	(*)
GSX-R750	08' - 10'	PRO	5294	(*)
GSX-R750	11' - 16'	R12	5697	(*)
GSX-R750	11' - 16'	PRO	5686	(*)
GSX-S750	17' - 18'	R12	5698	(*)
GSX-S750	17' - 18'	PRO	5687	(*)
GSX-R1000	07' - 08'	R12	4426	(*)
GSX-R1000	09' - 16'	R12	4961	(*)
GSX-R1000	09' - 16'	PRO	5295	(*)
GSX-R1000/R	17' - 18'	R12	9000	(*)
GSX-R1000/R	17' - 18'	PRO	9370	(*)
GSX-S125	17' - 18'	R12	9960	(*)
GSX-S1000	15' - 18'	R12	7721	(*)
GSX-S1000	15' - 18'	PRO	7704	(*)
GSX-S1000F	15' - 18'	R12	7722	(*)
GSX-S1000F	15' - 18'	PRO	7705	(*)
GSX-R1300 HAYABUSA	99' - 07'	R12 (-)	3919	(*)
GSX-R1300 HAYABUSA	08' - 12'	R12 (-)	4653	(*)
INAZUMA	13' - 17'	R12	6243	(*)
SFV650 GLADIUS	09' - 15'	R12	4962	(*)
SV650	03' - 06'	R12	1867	(*)
SV650S	03' - 08'	R12	1867	(*)
SV650	16' - 18'	R12	4962	(*)
SV650X	18'	R12	4962	(*)
TRIUMPH				
BONNEVILLE T100	16' - 18'	VINTAGE	8588	(*)
BONNEVILLE T120	16' - 18'	VINTAGE	8588	(*)
BONNEVILLE BOBBER	17' - 18'	VINTAGE	8588	(*)
DAYTONA 675	06' - 12'	R12	4631	(*)
DAYTONA 675/R	13' - 16'	R12	6570	(*)
SPEED TRIPLE	11' - 18'	R12	5696	(*)
SPEED TRIPLE R	12' - 18'	R12	5696	(*)
STREET TRIPLE	07' - 12'	R12	4631	(*)



VINTAGE

N
BlackPROT.
R12 / R19N
Black

PROT. PRO

N
Black

(*) Check price with your distributor.
 (-) Supplied with holesaw to drill bodywork.

IMPORTANT: Indicate code color after part#. Example: 0973A.

FRAME SLIDERS

HI-TECH PARTS | TYPE OF FRAME SLIDERS:

2019
MODELS:
www.puig.tv



FRAME SLIDER VINTAGE

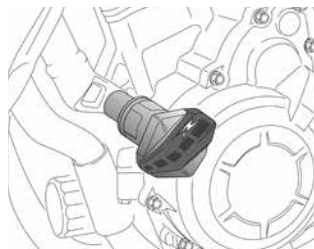

FRAME SLIDER R12 / R19

Spares for model R12 will be
manufactured with model R19.
Check website.

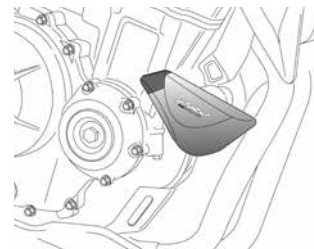

FRAME SLIDER PRO

MODEL	YEAR	TYPE OF FRAME SLIDER	REFERENCE	N
STREET TRIPLE R	09' - 12'	R12	4631	(*)
STREET CUP	17' - 18'	VINTAGE	8588	(*)
STREET TWIN	16' - 18'	VINTAGE	8588	(*)
THRUXTON 1200/R	16' - 18'	VINTAGE	8588	(*)
YAMAHA				
FAZER8	13' - 16'	PRO	5576	(*)
FAZER8	13' - 16'	R12	5584	(*)
FJR1300A/AS	06' - 12'	R12	4086	(*)
FJR1300A/AS	13' - 17'	R12	6572	(*)
FZS600 FAZER	98' - 04'	R12	1872	(*)
FZ1	06' - 15'	R12	5584	(*)
FZ1	06' - 15'	PRO	5576	(*)
FZ1 FAZER	06' - 15'	R12	5584	(*)
FZ1 FAZER	06' - 15'	PRO	5576	(*)
FZ6	04' - 08'	R12	1873	(*)
FZ6 FAZER	04' - 08'	R12	1873	(*)
FZ6 FAZER S2	07' - 10'	R12	1873	(*)
FZ8	10' - 16'	PRO	5576	(*)
FZ8	10' - 16'	R12	5584	(*)
FZ8 FAZER	10' - 12'	PRO	5576	(*)
FZ8 FAZER	10' - 12'	R12	5584	(*)
MT-125	15' - 18'	R12	7723	(*)
MT-03	16' - 18'	R12	8589	(*)
MT-03	16' - 18'	PRO	8590	(*)
MT-07	14' - 18'	R12	7064	(*)
MT-07	14' - 18'	PRO	7074	(*)
MT-07 TRACER	16' - 18'	R12	7064	(*)
MT-07 TRACER	16' - 18'	PRO	7074	(*)
MT-09	13' - 16'	R12	6857	(*)
MT-09	13' - 16'	PRO	7316	(*)

MODEL	YEAR	TYPE OF FRAME SLIDER	REFERENCE	N
MT-09	17' - 18'	R12	9380	(*)
MT-09	17' - 18'	PRO	7316	(*)
MT-09 SP	18'	R12	9380	(*)
MT-09 SP	18'	PRO	7316	(*)
MT-09 TRACER	15' - 18'	R12	6857	(*)
MT-09 TRACER	15' - 18'	PRO	7316	(*)
MT-09 TRACER GT	18'	R12	6857	(*)
MT-09 TRACER GT	18'	PRO	7316	(*)
MT-10	16' - 18'	R12	7724	(*)
MT-10	16' - 18'	PRO	8592	(*)
MT-10 SP	17' - 18'	R12	7724	(*)
MT-10 SP	17' - 18'	PRO	8592	(*)
TDM900	02' - 13'	R12	1874	(*)
XJ6	09' - 16'	R12	4948	(*)
XJ6 DIVERSION	09' - 16'	R12	4948	(*)
XSR 700	16' - 18'	PRO	7074	(*)
XSR 700	16' - 18'	VINTAGE	8593	(*)
XSR 900	16' - 18'	PRO	7316	(*)
XSR 900	16' - 18'	VINTAGE	8594	(*)
YBR 250	07' - 10'	R12	4851	(*)
YZF-R1	02' - 03'	R12	1876	(*)
YZF-R1	04' - 06'	R12	1878	(*)
YZF-R1 SP	06'	R12	1878	(*)
YZF-R1	07' - 08'	R12	4425	(*)
YZF-R1	09' - 13'	PRO	5549	(*)
YZF-R1	09' - 13'	R12	4958	(*)
YZF-R1	15' - 18'	R12	7724	(*)
YZF-R1	15' - 18'	PRO	7706	(*)
YZF-R1M	17' - 18'	R12	7724	(*)
YZF-R1M	17' - 18'	PRO	7706	(*)
YZF-R3	15' - 18'	R12	7725	(*)
YZF-R6	03' - 05'	R12	1877	(*)
YZF-R6	06' - 07'	R12	4064	(*)
YZF-R6	08' - 16'	PRO	5298	(*)
YZF-R6	08' - 16'	R12	4650	(*)
YZF-R6	17' - 18'	R12 (-)	9866	(*)



VINTAGE

N
BlackPROT.
R12 / R19N
Black

PROT. PRO

N
Black

(*) Check price with your distributor.
 (-) Supplied with holesaw to drill bodywork.

IMPORTANT: Indicate code color after part#. Example: 0973A.



brembo

ÖHLINS

HI-TECH
PARIS

DOT E
MADE IN ITALY

MIN. TH.



WEIGHT
Reduced weight
265 grams.



DESIGN
Racing look for your
motorcycle.

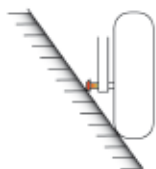

COMPLETE PROTECTION
Fork and swing arm
protection.

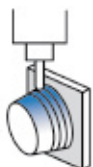

MATERIAL
Manufactured through a
nylon block.

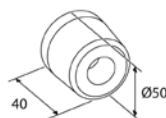

DIMENSIONS



The set of anodized aluminium rings must be ordered separately from the slider, depending on the color of the bike.

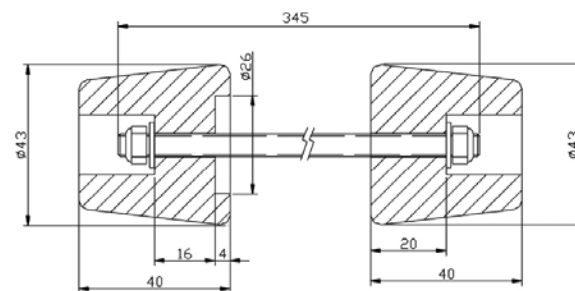

MODEL	REF.	N
UNIVERSAL	20097	

SPARES	REF.	N	A	T	O	P	R	V
NYLON MOD. UNIVERSAL RIGHT SIDE	20098							
NYLON MOD. UNIVERSAL RIGHT SIDE	20099							
SET OF ANODIZED ALUMINIUM RINGS	20025	(*)						

FOR SPECIFIC MODELS SEE PAGE 172





WEIGHT
Reduced weight
265 grams.



DESIGN
Racing look for your
motorcycle.

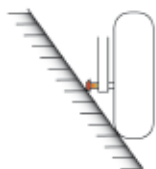

COMPLETE PROTECTION
Fork and swing arm
protection.

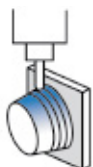

MATERIAL
Manufactured through a
nylon block.

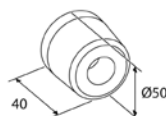

DIMENSIONS

// SET OF CAPS IN 4 COLORS INCLUDED

GREEN COLOR SOLD ONLY AS SPARE.

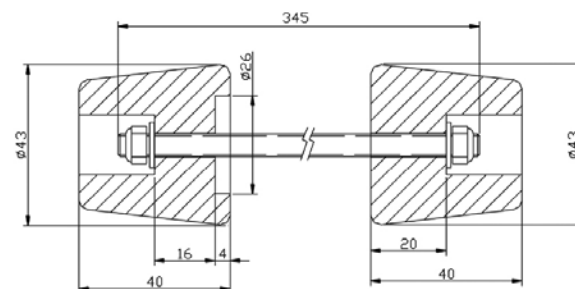
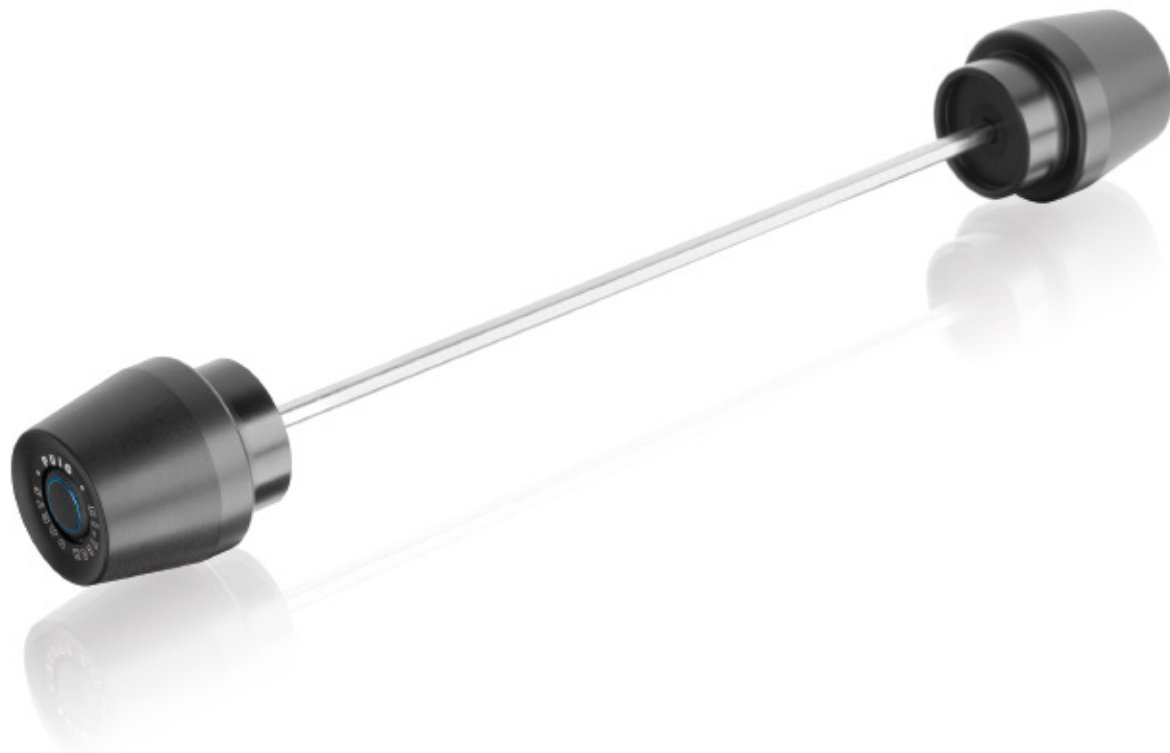

MODEL	REF.	N
UNIVERSAL	9031	(*)

SPARES	REF.	N	A	O	B	R	V
NYLON MOD. UNIVERSAL RIGHT SIDE	9032	(*)					
NYLON MOD. UNIVERSAL LEFT SIDE	9033	(*)					
NYLON CAPS BY PAIR	9034	(*)					

FOR SPECIFIC MODELS SEE PAGE 172

AXLE SLIDERS

HI-TECH PARTS | TYPE OF AXLE SLIDERS:

2019
MODELS:
www.puig.tv

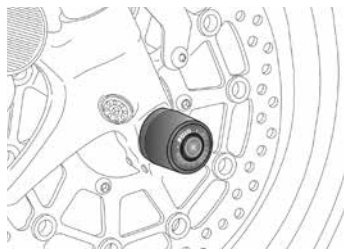

FRONT AXLE SLIDER

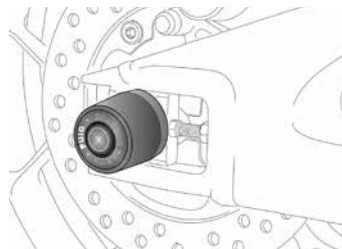

REAR AXLE SLIDER

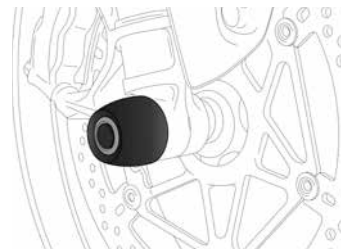

FRONT AXLE SLIDER PHB19



REAR AXLE SLIDER PHB19

MODEL	YEAR	TYPE DE PROTECTOR	REFERENCE	N
APRILIA				
CAPONORD 1200	13' - 16'	FRONT	8569	(*)
DORSODURO 900	17' - 18'	FRONT	8569	(*)
DORSODURO 900	17' - 18'	REAR	9868	(*)
RSV4	09' - 12'	FRONT	8569	(*)
SHIVER 750	07' - 16'	FRONT	8569	(*)
SHIVER 750	07' - 16'	REAR	8597	(*)
SHIVER 900	17' - 18'	FRONT	8569	(*)
SHIVER 900	17' - 18'	REAR	9868	(*)
BMW				
C650 SPORT	16' - 18'	FRONT	8599	(*)
F750 GS	18'	FRONT	9781	(*)
F750 GS	18'	REAR	9782	(*)
F850 GS	18'	FRONT	9781	(*)
F850 GS	18'	REAR	9782	(*)
F800 GT	13' - 16'	FRONT	8600	(*)
F800 GT	17' - 18'	FRONT	9517	(*)
F800 R	09' - 14'	FRONT	8601	(*)
F800 R	15' - 18'	FRONT	8602	(*)
F800 R	15' - 18'	REAR	8603	(*)
G310 GS	17' - 18'	FRONT	9486	(*)
G310 GS	17' - 18'	FRONT PHB19	20036 + 20025	(*)
G310 GS	17' - 18'	REAR	9487	(*)
G310 GS	17' - 18'	REAR PHB19	20037 + 20025	(*)
G310 R	16' - 18'	FRONT	9486	(*)
G310 R	16' - 18'	FRONT PHB19	20036 + 20025	(*)
G310 R	16' - 18'	REAR	9487	(*)
G310 R	16' - 18'	REAR PHB19	20037 + 20025	(*)
R1200 GS	13' - 16'	FRONT	8604	(*)
R1200 GS	13' - 16'	REAR PHB19	20030 + 20025	(*)
R1200 GS	13' - 16'	REAR	8545	(*)

MODEL	YEAR	TYPE DE PROTECTOR	REFERENCE	N
R1200 GS	17' - 18'	FRONT	8604	(*)
R1200 GS	17' - 18'	REAR	8545	(*)
R1200 GS	17' - 18'	REAR PHB19	20030 + 20025	(*)
R1200GS EXCLUSIVE	17' - 18'	FRONT	8604	(*)
R1200GS EXCLUSIVE	17' - 18'	REAR	8545	(*)
R1200GS EXCLUSIVE	17' - 18'	REAR PHB19	20030 + 20025	(*)
R1200GS RALLYE	17' - 18'	FRONT	8604	(*)
R1200GS RALLYE	17' - 18'	REAR	8545	(*)
R1200GS RALLYE	17' - 18'	REAR PHB19	20030 + 20025	(*)
R1200 GS ADVENTURE	14' - 18'	FRONT	8604	(*)
R1200 GS ADVENTURE	14' - 18'	REAR	8545	(*)
R1200 GS ADVENTURE	14' - 18'	REAR PHB19	20030 + 20025	(*)
R1250 GS	18'	FRONT	8604	(*)
R1250 GS	18'	REAR	8545	(*)
R1250 GS	18'	REAR PHB19	20030 + 20025	(*)
R1200 R	10' - 14'	FRONT	8606	(*)
R1200 R	15' - 18'	FRONT	8538	(*)
R1200 R	15' - 18'	REAR	8545	(*)
R1200 R	15' - 18'	REAR PHB19	20030 + 20025	(*)
R1200 RS	15' - 18'	FRONT	8538	(*)
R1200 RS	15' - 18'	REAR	8545	(*)
R1200 RS	15' - 18'	REAR PHB19	20030 + 20025	(*)
R NINE T	14' - 18'	FRONT	8607	(*)
R NINE T URBAN G/S	17' - 18'	FRONT	8608	(*)
R NINE T URBAN G/S	17' - 18'	REAR	8545	(*)
R NINE T URBAN G/S	17' - 18'	REAR PHB19	20030 + 20025	(*)
R NINE T PURE	17' - 18'	FRONT	8608	(*)
R NINE T PURE	17' - 18'	REAR	8545	(*)
R NINE T PURE	17' - 18'	REAR PHB19	20030 + 20025	(*)
R NINE T RACER	17' - 18'	FRONT	8608	(*)
R NINE T RACER	17' - 18'	REAR	8545	(*)
R NINE T RACER	17' - 18'	REAR PHB19	20030 + 20025	(*)
R NINE T SCRAMBLER	16' - 18'	FRONT	8608	(*)
S1000 R	14' - 18'	FRONT	8521	(*)
S1000 R	14' - 18'	REAR	8522	(*)
S1000 RR	09' - 18'	FRONT	8521	(*)
S1000 RR	09' - 18'	REAR	8522	(*)
S1000 XR	15' - 18'	FRONT	8538	(*)



N
Black

(*) Check price with your distributor.

IMPORTANT: Indicate code color after part#. Example: 0973A.

AXLE SLIDERS

HI-TECH PARTS | TYPE OF AXLE SLIDERS:

2019
MODELS:
www.puig.tv

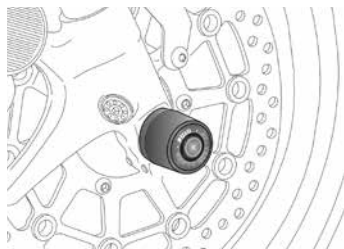

FRONT AXLE SLIDER

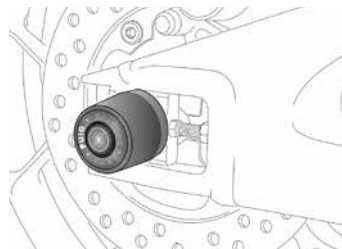

REAR AXLE SLIDER

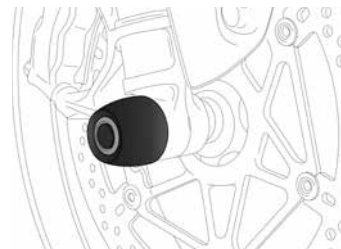

FRONT AXLE SLIDER PHB19



REAR AXLE SLIDER PHB19

MODEL	YEAR	TYPE DE PROTECTOR	REFERENCE	N
S1000 XR	15' - 18'	REAR	8522	(*)
DUCATI				
X DIAVEL/S	16' - 18'	FRONT	8611	(*)
X DIAVEL/S	16' - 18'	REAR	8632	(*)
848	08' - 13'	FRONT	8523	(*)
848 EVO	11' - 13'	FRONT	8523	(*)
899 PANIGALE	14' - 15'	FRONT	8615	(*)
959 PANIGALE/CORSE	16' - 18'	FRONT	8615	(*)
1199 PANIGALE	12' - 14'	FRONT	8615	(*)
1199 SUPERLEGGERA	14'	FRONT	8615	(*)
PANIGALE V4	18'	FRONT	9752	(*)
PANIGALE V4	18'	REAR	9601	(*)
PANIGALE V4 S	18'	FRONT	9752	(*)
PANIGALE V4 S	18'	REAR	9601	(*)
PANIGALE V4 SPECIALE	18'	FRONT	9752	(*)
PANIGALE V4 SPECIALE	18'	REAR	9601	(*)
HYPERMOTARD 796	10' - 13'	FRONT	8620	(*)
HYPERMOTARD 1100/S	07' - 09'	FRONT	8620	(*)
HYPERMOTARD 1100 EVO	10' - 12'	FRONT	8620	(*)
HYPERMOTARD 1100 EVO SP	10' - 12'	FRONT	8620	(*)
HYPERMOTARD 821/SP	13' - 15'	FRONT	8622	(*)
HYPERMOTARD 821/SP	13' - 15'	REAR	8623	(*)
HYPERMOTARD 939/SP	16' - 18'	FRONT	8622	(*)
HYPERMOTARD 939/SP	16' - 18'	REAR	8623	(*)
HYPERSTRADA	13' - 15'	FRONT	8622	(*)
HYPERSTRADA 939	16' - 17'	FRONT	8628	(*)
HYPERSTRADA 939	16' - 17'	REAR	8625	(*)
MONSTER 696	08' - 14'	FRONT	8515	(*)
MONSTER 796	10' - 14'	FRONT	8515	(*)
MONSTER 797	17' - 18'	FRONT	8629	(*)
MONSTER 797	17' - 18'	REAR	9498	(*)



MODEL	YEAR	TYPE DE PROTECTOR	REFERENCE	N
MONSTER 821	14' - 18'	FRONT	8629	(*)
MONSTER 821	14' - 17'	REAR	8630	(*)
MONSTER 821	18'	REAR	9605	(*)
MONSTER 1100/S	09' - 10'	FRONT	8515	(*)
MONSTER 1100 EVO	11' - 13'	FRONT	8515	(*)
MONSTER 1200/S	14' - 18'	FRONT	8622	(*)
MONSTER 1200/S	14' - 16'	REAR	8632	(*)
MONSTER 1200/S	17' - 18'	REAR	9601	(*)
MONSTER 1200 R	16' - 18'	FRONT	8622	(*)
MONSTER 1200 R	16' - 18'	REAR	8632	(*)
MULTISTRADA 950	17' - 18'	FRONT	8622	(*)
MULTISTRADA 1200/S	10' - 14'	FRONT	8622	(*)
MULTISTRADA 1200/S	15' - 17'	FRONT	8622	(*)
MULTISTRADA 1200/S	15' - 17'	REAR	8632	(*)
MULTISTRADA 1200 PIKES PEAK	16' - 17'	FRONT	8622	(*)
MULTISTRADA 1200 PIKES PEAK	16' - 17'	REAR	8632	(*)
MULTISTRADA 1200 ENDURO/PRO	16' - 18'	FRONT	8622	(*)
MULTISTRADA 1200 ENDURO/PRO	16' - 18'	REAR	8632	(*)
MULTISTRADA 1260/S/S D AIR	18'	FRONT	8622	(*)
MULTISTRADA 1260/S/S D AIR	18'	REAR	8101	(*)
MULTISTRADA 1260 PIKES PEAK	18'	FRONT	8622	(*)
MULTISTRADA 1260 PIKES PEAK	18'	REAR	9601	(*)
SCRAMBLER CAFE RACER	17' - 18'	FRONT	8101	(*)
SCRAMBLER CAFE RACER	17' - 18'	REAR	8102	(*)
SCRAMBLER CLASSIC	15' - 18'	FRONT	8101	(*)
SCRAMBLER CLASSIC	15' - 18'	REAR	8102	(*)
SCRAMBLER DESERT SLED	17' - 18'	FRONT	9852	(*)
SCRAMBLER DESERT SLED	17' - 18'	FRONT PHB19	20042 + 20025	(*)
SCRAMBLER DESERT SLED	17' - 18'	REAR	8102	(*)
SCRAMBLER FLAT TRACK PRO	16'	FRONT	8101	(*)
SCRAMBLER FLAT TRACK PRO	16'	REAR	8102	(*)
SCRAMBLER FULL THROTTLE	15' - 18'	FRONT	8101	(*)
SCRAMBLER FULL THROTTLE	15' - 18'	REAR	8102	(*)
SCRAMBLER ICON	15' - 18'	FRONT	8101	(*)
SCRAMBLER ICON	15' - 18'	REAR	8102	(*)
SCRAMBLER URBAN ENDURO	15' - 16'	FRONT	8101	(*)
SCRAMBLER URBAN ENDURO	15' - 16'	REAR	8102	(*)
SCRAMBLER SIXTY2	16' - 18'	FRONT	8101	(*)



N
Black

(*) Check price with your distributor.

IMPORTANT: Indicate code color after part#. Example: 0973A.

AXLE SLIDERS

HI-TECH PARTS | TYPE OF AXLE SLIDERS:

2019
MODELS:
www.puig.tv

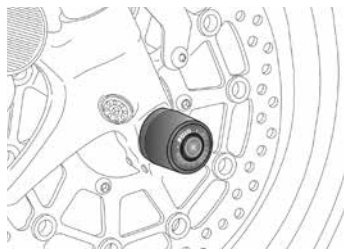

FRONT AXLE SLIDER

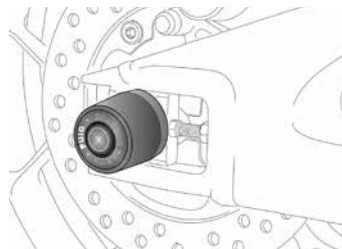

REAR AXLE SLIDER

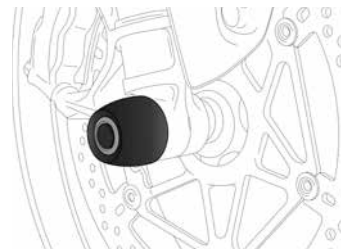

FRONT AXLE SLIDER PHB19



REAR AXLE SLIDER PHB19

MODEL	YEAR	TYPE DE PROTECTOR	REFERENCE	N
SCRAMBLER SIXTY2	16' - 18'	REAR	8102	(*)
SCRAMBLER 1100	18'	FRONT	9852	(*)
SCRAMBLER 1100	18'	FRONT PHB19	20042 + 20025	(*)
SCRAMBLER 1100	18'	REAR	8102	(*)
SCRAMBLER 1100 SPORT	18'	FRONT	9852	(*)
SCRAMBLER 1100 SPORT	18'	FRONT PHB19	20042 + 20025	(*)
SCRAMBLER 1100 SPORT	18'	REAR	8102	(*)
SCRAMBLER 1100 SPECIAL	18'	FRONT	9852	(*)
SCRAMBLER 1100 SPECIAL	18'	FRONT PHB19	20042 + 20025	(*)
SCRAMBLER 1100 SPECIAL	18'	REAR	8102	(*)
STREETFIGHTER 848	12' - 15'	FRONT	8640	(*)
STREETFIGHTER 1100	09' - 12'	FRONT	8641	(*)
STREETFIGHTER 1100 S	09' - 13'	FRONT	8641	(*)
SUPERSPORT 939/S	17' - 18'	FRONT	8629	(*)
HONDA				
CB600F HORNET	07' - 15'	FRONT	8512	(*)
CB650F	14' - 18'	FRONT	8643	(*)
CB650F	14' - 18'	FRONT PHB19	20031 + 20025	(*)
CB1000R	08' - 16'	FRONT	8512	(*)
CB1000R NEO SPORTS CAFE	18'	FRONT	9755	(*)
CB1000R NEO SPORTS CAFE	18'	REAR	9756	(*)
CB1000R NEO SPORTS CAFE	18'	REAR PHB19	20041 + 20025	(*)
CBR600F	11' - 13'	FRONT	9148	(*)
CBR650F	14' - 18'	FRONT	8643	(*)
CBR650F	14' - 18'	FRONT PHB19	20031 + 20025	(*)
CBR600RR	05' - 12'	FRONT	8107	(*)
CBR600RR	05' - 12'	REAR	8516	(*)
CBR600RR	13' - 16'	FRONT	8646	(*)
CBR600RR	13' - 16'	REAR	8647	(*)
CBR1000RR FIREBLADE	06' - 07'	FRONT	8520	(*)
CBR1000RR FIREBLADE	06' - 07'	REAR	8648	(*)

MODEL	YEAR	TYPE DE PROTECTOR	REFERENCE	N
CBR1000RR FIREBLADE	08' - 11'	FRONT	8108	(*)
CBR1000RR FIREBLADE	08' - 11'	REAR	8517	(*)
CBR1000RR FIREBLADE	12' - 13'	FRONT	8108	(*)
CBR1000RR FIREBLADE	12' - 13'	REAR	8517	(*)
CBR1000RR FIREBLADE/SP	14' - 16'	FRONT	8108	(*)
CBR1000RR FIREBLADE/SP	14' - 16'	REAR	8517	(*)
CBR1000RR FIREBLADE/SP/SP2	17' - 18'	FRONT	8108	(*)
CBR1000RR FIREBLADE/SP/SP2	17' - 18'	REAR	9504	(*)
CROSSRUNNER	15' - 18'	FRONT	8652	(*)
X-ADV	17' - 18'	FRONT	9482	(*)
X-ADV	17' - 18'	REAR	9483	(*)
KAWASAKI				
VERSYS 650	15' - 18'	FRONT	8539	(*)
VERSYS 1000	12' - 18'	FRONT	8528	(*)
NINJA 650	17' - 18'	FRONT	9356	(*)
NINJA H2 SX	18'	FRONT	9715	(*)
Z650	17' - 18'	FRONT	9356	(*)
Z750	07' - 12'	FRONT	8513	(*)
Z750R	11' - 12'	FRONT	8653	(*)
Z800/E	13' - 16'	FRONT	8654	(*)
Z900	17' - 18'	FRONT	8513	(*)
Z900RS	18'	FRONT	8513	(*)
Z1000	07' - 09'	FRONT	8655	(*)
Z1000	10' - 13'	FRONT	8513	(*)
Z1000	14' - 18'	FRONT	8535	(*)
Z1000	14' - 18'	FRONT PHB19	20027 + 20025	(*)
Z1000R	17' - 18'	FRONT	8535	(*)
Z1000R	17' - 18'	FRONT PHB19	20027 + 20025	(*)
Z1000SX	11' - 16'	FRONT	8513	(*)
Z1000SX	17' - 18'	FRONT	8535	(*)
Z1000SX	17' - 18'	FRONT PHB19	20027 + 20025	(*)
ZX-6R	07' - 13'	FRONT	8656	(*)
ZX-6R 636	13' - 16'	FRONT	8531	(*)
ZX-10R	06' - 07'	FRONT	8519	(*)
ZX-10R	08' - 10'	FRONT	8656	(*)
ZX-10R	11' - 15'	FRONT	8525	(*)
ZX-10R	16' - 18'	FRONT	8658	(*)
ZX-10RR	17' - 18'	FRONT	8658	(*)



N
Black

(*) Check price with your distributor.

IMPORTANT: Indicate code color after part#. Example: 0973A.

AXLE SLIDERS

HI-TECH PARTS | TYPE OF AXLE SLIDERS:

2019
MODELS:
www.puig.tv

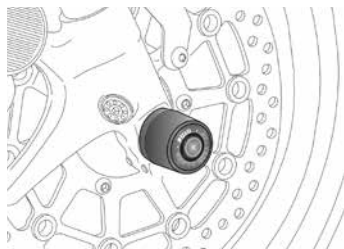

FRONT AXLE SLIDER

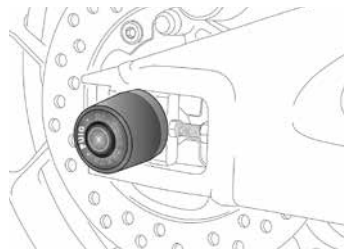

REAR AXLE SLIDER

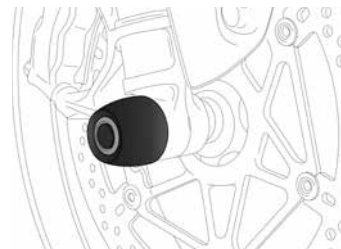

FRONT AXLE SLIDER PHB19



REAR AXLE SLIDER PHB19

MODEL	YEAR	TYPE DE PROTECTOR	REFERENCE	N
ZX-10R SE	18'	FRONT	8658	(*)
ZZR1400	12' - 15'	FRONT	8529	(*)
KTM				
790 DUKE	18'	FRONT	9684	(*)
790 DUKE	18'	REAR	9685	(*)
1290 SUPERDUKE GT	16' - 18'	FRONT	8665	(*)
1290 SUPERDUKE R	14' - 18'	FRONT	8665	(*)
KYMCO				
AK 550	17' - 18'	FRONT	9535	(*)
AK 550	17' - 18'	FRONT PHB19	20039 + 20025	(*)
AK 550	17' - 18'	REAR	9536	(*)
AK 550	17' - 18'	REAR PHB19	20040 + 20025	(*)
MV AGUSTA				
BRUTALE 800/RR	13' - 18'	FRONT	8668	(*)
BRUTALE DRAGSTER 800/RR	14' - 18'	FRONT	8668	(*)
TURISMO VELOCE 800	14' - 18'	FRONT	8668	(*)
TURISMO VELOCE 800 LUSSO	14' - 18'	FRONT	8668	(*)
SUZUKI				
DL1000 V-STROM	14' - 18'	FRONT	8672	(*)
DL1000 V-STROM	14' - 18'	REAR	8673	(*)
DL1000XT V-STROM	17' - 18'	FRONT	8672	(*)
DL1000XT V-STROM	17' - 18'	REAR	8673	(*)
GSR600	06' - 11'	FRONT	8674	(*)
GSR750	11' - 16'	FRONT	8675	(*)
GSX-R600	06' - 10'	FRONT	8676	(*)
GSX-R600	06' - 10'	FRONT PHB19	20032 + 20025	(*)
GSX-R600	06' - 10'	REAR	8677	(*)
GSX-R600	11' - 16'	FRONT	8524	(*)
GSX-R600	11' - 16'	REAR	8526	(*)
GSX-R750	06' - 10'	FRONT	8676	(*)
GSX-R750	06' - 10'	FRONT PHB19	20032 + 20025	(*)

MODEL	YEAR	TYPE DE PROTECTOR	REFERENCE	N
GSX-R750	06' - 10'	REAR	8677	(*)
GSX-R750	11' - 16'	FRONT	8524	(*)
GSX-R750	11' - 16'	REAR	8526	(*)
GSX-S750	17' - 18'	FRONT	9425	(*)
GSX-S750	17' - 18'	REAR	9426	(*)
GSX-R1000	07' - 11'	FRONT	8680	(*)
GSX-R1000	12' - 16'	FRONT	8527	(*)
GSX-R1000	12' - 16'	REAR	8530	(*)
GSX-R1000/R	17' - 18'	FRONT	9001	(*)
GSX-R1000/R	17' - 18'	FRONT PHB19	20034 + 20025	(*)
GSX-R1000/R	17' - 18'	REAR	9002	(*)
GSX-S1000	15' - 18'	FRONT	8681	(*)
GSX-S1000	15' - 18'	REAR	8682	(*)
GSX-S1000F	15' - 18'	FRONT	8681	(*)
GSX-S1000F	15' - 18'	REAR	8682	(*)
TRIUMPH				
DAYTONA 675	06' - 12'	FRONT	8511	(*)
DAYTONA 675	06' - 12'	REAR	8532	(*)
DAYTONA 675 R	11' - 12'	FRONT	8511	(*)
DAYTONA 675 R	11' - 12'	REAR	8532	(*)
DAYTONA 675/R	13' - 16'	FRONT	8511	(*)
DAYTONA 675/R	13' - 16'	REAR	8532	(*)
SPEED TRIPLE	11' - 15'	FRONT	8511	(*)
SPEED TRIPLE R	12' - 15'	FRONT	8511	(*)
SPEED TRIPLE/R	16' - 18'	FRONT	8687	(*)
STREET CUP	17' - 18'	FRONT	9510	(*)
STREET CUP	17' - 18'	FRONT PHB19	20038 + 20025	(*)
STREET TRIPLE	07' - 18'	FRONT	8511	(*)
STREET TRIPLE	07' - 18'	REAR	8532	(*)
STREET TRIPLE R	09' - 18'	FRONT	8511	(*)
STREET TRIPLE R	09' - 18'	REAR	8532	(*)
STREET TRIPLE S	17' - 18'	FRONT	9510	(*)
STREET TRIPLE S	17' - 18'	REAR	8532	(*)
STREET TRIPLE S	17' - 18'	FRONT PHB19	20038 + 20025	(*)
STREET TRIPLE RS	17' - 18'	FRONT	8511	(*)
STREET TRIPLE RS	17' - 18'	REAR	8532	(*)
STREET TWIN	16' - 18'	FRONT	9158	(*)
THRUXTON 1200/R	16' - 18'	FRONT	9238	(*)



N
Black

(*) Check price with your distributor.

IMPORTANT: Indicate code color after part#. Example: 0973A.

AXLE SLIDERS

HI-TECH PARTS | TYPE OF AXLE SLIDERS:

2019
MODELS:
www.puig.tv

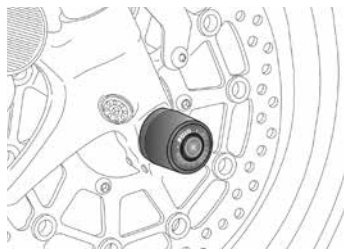

FRONT AXLE SLIDER

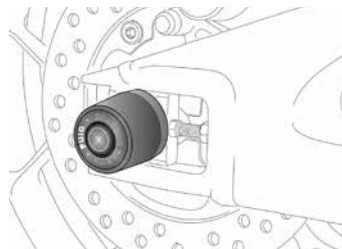

REAR AXLE SLIDER

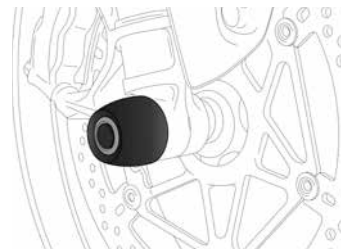

FRONT AXLE SLIDER PHB19



REAR AXLE SLIDER PHB19

MODEL	YEAR	TYPE DE PROTECTOR	REFERENCE	N
TIGER 800/XC	11' - 14'	FRONT	8688	(*)
TIGER 800/XC	11' - 14'	REAR	8689	(*)
TIGER 800 XC/XCX/XCA/XR/XRX/XRT	15' - 18'	FRONT	8688	(*)
TIGER 800 XC/XCX/XCA/XR/XRX/XRT	15' - 18'	REAR	8689	(*)
TIGER SPORT	13' - 18'	FRONT	8690	(*)
TIGER EXPLORER XC/XR/XRX/XRT/XCX/XCA	16' - 18'	FRONT	8691	(*)
YAMAHA				
FZ1/FAZER	06' - 15'	FRONT	8692	(*)
FZ6	04' - 08'	FRONT	8514	(*)
FZ6	04' - 08'	FRONT PHB19	20026 + 20025	(*)
FZ6 FAZER	04' - 08'	FRONT	8514	(*)
FZ6 FAZER	04' - 08'	FRONT PHB19	20026 + 20025	(*)
FZ6 FAZER S2	07' - 10'	FRONT	8514	(*)
FZ6 FAZER S2	07' - 10'	FRONT PHB19	20026 + 20025	(*)
MT-03	16' - 18'	FRONT	8706	(*)
MT-03	16' - 18'	REAR	8707	(*)
MT-07	14' - 18'	FRONT	8536	(*)
MT-07	14' - 18'	FRONT PHB19	20027 + 20025	(*)
MT-07	14' - 18'	REAR	8537	(*)
MT-07	14' - 18'	REAR PHB19	20029 + 20025	(*)
MT-09	13' - 16'	FRONT	9381	(*)
MT-09	13' - 16'	REAR	8534	(*)
MT-09	17' - 18'	FRONT	9381	(*)
MT-09	17' - 18'	REAR	9382	(*)
MT-09 SP	18'	FRONT	9381	(*)
MT-09 SP	18'	REAR	9382	(*)
MT-09 TRACER	15' - 18'	FRONT	9381	(*)
MT-09 TRACER	15' - 18'	REAR	8534	(*)
MT-09 TRACER GT	18'	FRONT	9381	(*)
MT-09 TRACER GT	18'	REAR	8534	(*)
MT.10	16' - 18'	FRONT	8704	(*)

MODEL	YEAR	TYPE DE PROTECTOR	REFERENCE	N
MT-10	16' - 18'	REAR	8705	(*)
MT-10	16' - 18'	REAR PHB19	20033 + 20025	(*)
MT-10 SP	17' - 18'	FRONT	8704	(*)
MT-10 SP	17' - 18'	REAR	8705	(*)
MT-10 SP	17' - 18'	REAR PHB19	20033 + 20025	(*)
T-MAX 500	08' - 11'	FRONT	8697	(*)
T-MAX 530	12' - 14'	FRONT	8697	(*)
T-MAX 530	12' - 14'	REAR	8699	(*)
T-MAX 530	15' - 16'	FRONT	8700	(*)
T-MAX 530	15' - 16'	REAR	8699	(*)
T-MAX 530/DX/SX	17' - 18'	FRONT	8700	(*)
T-MAX 530/DX/SX	17' - 18'	REAR	9469	(*)
T-MAX 530/DX/SX	17' - 18'	REAR PHB19	20035 + 20025	(*)
XSR700	16' - 18'	FRONT	8536	(*)
XSR700	16' - 18'	REAR	8537	(*)
XSR700	16' - 18'	REAR PHB19	20029 + 20025	(*)
XSR900	16' - 18'	FRONT	9381	(*)
XSR900	16' - 18'	REAR	8534	(*)
XT 1200 Z SUPERTENERE	14' - 18'	FRONT	8709	(*)
YZF-R1	07' - 14'	FRONT	8702	(*)
YZF-R1	07' - 14'	REAR	8703	(*)
YZF-R1	15' - 18'	FRONT	8704	(*)
YZF-R1	15' - 18'	REAR	8705	(*)
YZF-R1	15' - 18'	REAR PHB19	20033 + 20025	(*)
YZF-R1M	17' - 18'	FRONT	8704	(*)
YZF-R1M	17' - 18'	REAR	8705	(*)
YZF-R1M	17' - 18'	REAR PHB19	20033 + 20025	(*)
YZF-R3	15' - 18'	FRONT	8706	(*)
YZF-R3	15' - 18'	REAR	8707	(*)
YZF-R6	06' - 16	FRONT	8702	(*)
YZF-R6	06' - 16'	REAR	8518	(*)
YZF-R6	17' - 18'	FRONT	8704	(*)
YZF-R6	17' - 18'	REAR	9843	(*)



N
Black

(*) Check price with your distributor.

IMPORTANT: Indicate code color after part#. Example: 0973A.



Puig

MATERIAL

Manufactured in 4mm thick polypropylene for strength, durability and good appearance. The covers are simply bolt-on on the oem engine case.

Compact for a maximum distance to the ground, matt finished, and protecting one of the most vulnarable areas of the machine.



FOR SPECIFIC MODELS CHECK WEB



MODEL	YEAR	Ø	REF.	N	U	I
APRILIA						
CAPONORD 1200	13' - 16'	25 mm.	6543	(*)		
BMW						
F650 GS	08' - 12'	25 mm.	5983	(*)		
F700 GS	12' - 17'	25 mm.	5983	(*)		
F750GS	18'	25 mm.	9780	(*)		
F800 GS	08' - 12'	25 mm.	5983	(*)		
F800 GS	13' - 17'	25 mm.	6537	(*)		
F850GS	18'	25 mm.	9780	(*)		
G650 GS	11' - 16'	25 mm.	5977	(*)		
R1200 GS	04' - 12'	25 mm.	5986	(*)		
R1200GS - LOW	13'	25 mm.	6538	(*)	(*)	
R1200GS - HIGH	14' - 16'	25 mm.	7542	(*)	(*)	
R1200GS - LOW	14' - 16'	25 mm.	7543	(*)	(*)	
R1200GS - HIGH	17' - 18'	25 mm.	9461	(*)	(*)	
R1200GS - LOW	17' - 18'	25 mm.	7543	(*)	(*)	
R1200GS RALLYE/EXCLUSIVE-HIGH	17' - 18'	25 mm.	9461	(*)	(*)	
R1200GS RALLYE/EXCLUSIVE-LOW	17' - 18'	25 mm.	7543	(*)	(*)	
R1250GS	18'	25 mm.		(*)	(*)	
R1250GS	18'	25 mm.		(*)	(*)	
R1200R	15' - 18'	25 mm.	7768	(*)		
R1200RS	15' - 18'	25 mm.	7768	(*)		
R NINE T	14' - 18'	25 mm.	7095	(*)		
R NINE T SCRAMBLER	16' - 18'	25 mm.	7095	(*)		
R NINE T RACER	17' - 18'	25 mm.	7095	(*)		
R NINE T PURE	17' - 18'	25 mm.	7095	(*)		
R NINE T URBAN G/S	17' - 18'	25 mm.	7095	(*)		
DUCATI						
MULTISTRADA 1200/S	10' - 14'	25 mm.	7002	(*)		
HONDA						
CB500F/X	13' - 18'	25 mm.	6539	(*)		
CB1100	13' - 14'	25 mm.	6540			(*)
CB1100RS	17' - 18'	25 mm.	6540			(*)
CB1100EX	17' - 18'	25 mm.	6540			(*)



N Black
U Grey
I Stainless

MODEL	YEAR	Ø	REF.	N	U	I
CROSSRUNNER	15' - 18'	25 mm.	7772	(*)		
NC700S/X	12' - 13'	25 mm.	6387(#)	(*)		
NC750S/X	14' - 18'	25 mm.	6387(#)	(*)		
X-ADV	17' - 18'	25 mm.	9481	(*)		
KAWASAKI						
VERSYS 650	10' - 14'	25 mm.	5985	(*)		
VERSYS 650	15' - 18'	25 mm.	7773	(*)		
VERSYS 1000	12' - 14'	25 mm.	6801	(*)		
VERSYS 1000	15' - 18'	25 mm.	7774	(*)		
VULCAN S	15' - 18'	25 mm.	8544	(*)		
VULCAN S CAFE	17' - 18'	25 mm.	8544	(*)		
KTM						
1050 ADVENTURE	15' - 16'	25 mm.	6541	(*)		
1190 ADVENTURE/R	13' - 16'	25 mm.	6541	(*)		
TRIUMPH						
TIGER EXPLORER	12' - 15'	25 mm.	6386	(*)		
TIGER EXPLORER XC	13' - 15'	25 mm.	6386	(*)		
SUZUKI						
DL650 V-STROM	12' - 18'	25 mm.	5884	(*)		
DL650XT V-STROM	15' - 18'	25 mm.	5884	(*)		
DL1000 V-STROM	14' - 18'	25 mm.	6542	(*)		
DL1000 V-STROM/XT	17' - 18'	25 mm.	6542	(*)		
YAMAHA						
MT-09 TRACER	15' - 17'	25 mm.	7777	(*)		
MT-09 TRACER	18'	25 mm.	9720	(*)		
MT-09 TRACER GT	18'	25 mm.	9720	(*)		
MT-07 TRACER	16' - 18'	25 mm.	9206	(*)		

(*) Check price with your distributor.

(#) Compatible with DCT models.

Previously verify any interference between our product and any other accessory (OEM or aftermarket) already installed on the motorcycle.

IMPORTANT: Indicate code color after part#. Example: 0973A.

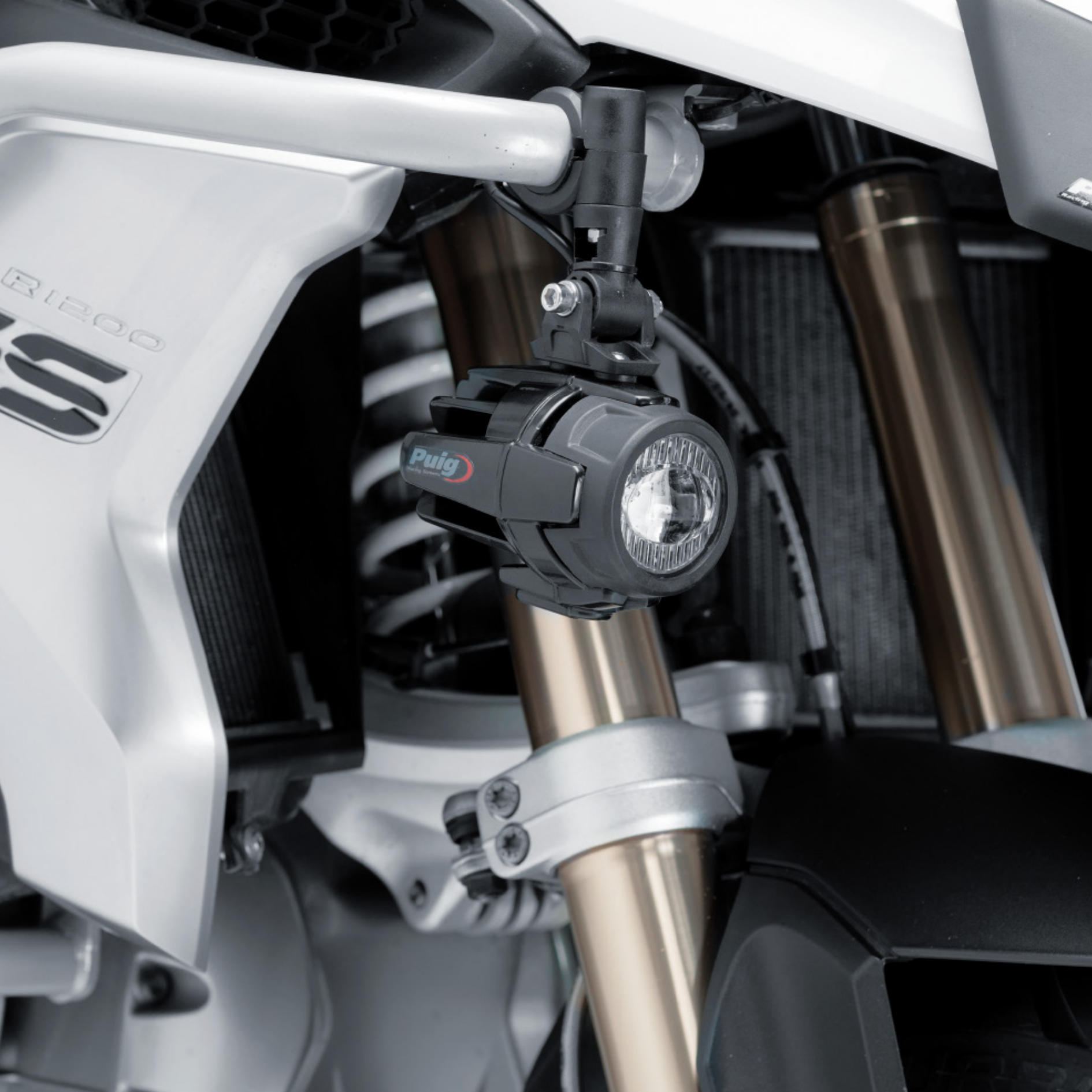

R1200

M

Puig

Universal fog lights and aluminium case painted black.

LED technology with low electrical consumption, avoiding risking the battery due to excessive usage.

Supplied with instructions on our engine guards. Fit engine guards between 20.5 and 25mm diameter.

Equipped with a fuse and cables to connect directly to your battery and with a water proof switch to be installed on your handlebars.

Aluminium case designed to favor heat dissipation.

Optional metallic grill protections for offroad use.

Sells separately (Part# 9785N).

TECHNICAL FEATURES:

Low consumption: 40W (20W per light)

Voltage: DC 12-24V

Lumens: 4000L M(2000L M/light)

Material: PC lens / aluminium case

MOUNTING: To mount the auxiliary lights on the Puig engine guards use only one of the two spacers that carries the support and the allen screw M6x50.



MODEL	REF.	PRICE
UNIVERSAL		
SET OF AUXILIARY LIGHT (1)	9773N	(*)
SET OF METALLIC GRILL PROTECTION (2)	9785N	(*)

AVAILABLE MODELS [CHECK WEB](#)
 SPECIFIC SUPPORTS FOR AUXILIARY LIGHT [CHECK PÁG.189](#)





FUNCTION

Allow mounting of the lights on bikes that don't mount tube engine guards



MATERIAL

Made of steel. Finished with epoxy black paint.

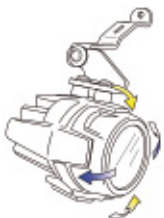

ADJUSTABLE

Sideways and on inclination.

SPECIFIC SUPPORTS	YEAR	REF.	PRICE
HONDA			
CB1000R NEO SPORTS CAFE	18'	1943N	(*)
TRIUMPH			
TIGER 800 XC/XCX/XCA/XR/XRX/XRT	18'	1350N	(*)

MODEL	REF.	PRICE
UNIVERSAL		
SET OF AUXILIARY LIGHT	9773N	(*)
SET OF METALLIC GRILL PROTECTION	9785N	(*)

(*) Check price with your distributor.

AVAILABLE MODELS [CHECK WEB](#)



MODEL	YEAR	REF.	(W)
BMW			
G310 GS	17' - 18'	CHECK WEB	
F700 GS	12' -17'	8123W	(*)
F750 GS	18'	9762W	(*)
F800 GS	08' - 17'	8123W	(*)
F850GS	18'	9762W	(*)
F800 GS ADVENTURE	13' - 18'	8123W	(*)
R1200 GS	04' - 12'	7577W	(*)
R1200 GS	13' - 18'	7567W	(*)
R1200 GS ADVENTURE	06' - 13'	7577W	(*)
R1200 GS ADVENTURE	14' - 18'	7567W	(*)
R1200 GS RALLYE/EXCLUSIVE	17' - 18'	7567W	(*)
R1250 GS	18'	7567W	(*)
DUCATI			
MULTISTRADA 950	17' - 18'	9401W	(*)
MULTISTRADA 1200/S	15' - 17'	9401W	(*)
MULTISTRADA 1200 ENDURO/PRO	16' - 18'	9401W	(*)
MULTISTRADA 1260/S/S DJAIR	18'	9401W	(*)
MULTISTRADA 1260 PIKES PEAK	18'	9401W	(*)
HONDA			
CRF1000L AFRICA TWIN	16' - 18'	8714W	(*)
CRF1000L AFRICA TWIN ADVENTURE SPORTS	18'	8714W	(*)
NC750X	16' - 18'	9166W	(*)
KAWASAKI			
VERSYS-X 300	17' - 18'	CHECK WEB	
KTM			
1050 ADVENTURE	15' - 16'	8132W	(*)
1090 ADVENTURE/R	17' - 18'	8132W	(*)
1190 ADVENTURE/R	13' -16'	8132W	(*)
1290 SUPER ADVENTURE	15' -16'	8132W	(*)
1290 SUPER ADVENTURE T	17'	8132W	(*)
1290 SUPER ADVENTURE R	17' - 18'	9470W	(*)
1290 SUPER ADVENTURE S	17' - 18'	9470W	(*)
SUZUKI			
DL650 V-STROM	12' - 16'	8125W	(*)
DL650 V-STROM XT	15' -16'	8125W	(*)
DL650 V-STROM	17' - 18'	9736W	(*)
DL650 V-STROM XT	17' - 18'	9736W	(*)
DL1000 V-STROM	15' -16'	8126W	(*)
DL1000 V-STROM	17' - 18'	9737W	(*)
DL1000 V-STROM XT	17' - 18'	9737W	(*)

MODEL	YEAR	REF.	(W)
TRIUMPH			
TIGER 800	11' - 14'	8124W	(*)
TIGER 800 XC	11' - 14'	8124W	(*)
TIGER 800 XC/XCX/XCA	15' - 18'	8124W	(*)
TIGER 800 XR/XRX/XRT	15' - 18'	8124W	(*)
TIGER EXPLORER	12' - 15'	8124W	(*)
TIGER EXPLORER XC	13' - 15'	8124W	(*)
TIGER EXPLORER XC/XR/XRX/XRT/XCX/XCA	16' - 18'	8124W	(*)
YAMAHA			
MT-09 TRACER	15' -17'	8127W	(*)
MT-09 TRACER	18'	9728W	(*)
MT-07 TRACER	16' -18'	9215W	(*)
XT1200Z SUPER TÉNÉRÉ	10' -18'	8417W	(*)

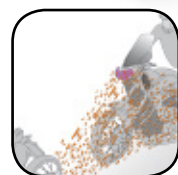

PROTECTION

Avoid impact of objects or insects on the headlight.



W

Transparent

(*) Check price with your distributor.

IMPORTANT: Indicate code color after part#. Example: 0973A.





ADJUSTABLE
Fixed or adjustable on inclination.

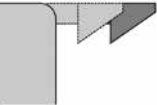

TURN LIGHTS
Adjustable lodge for turn signals.

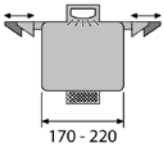

UNIVERSAL
Most suitable for license plates.

KIT
It is supplied with light and reflector, both homologated.
According to models.

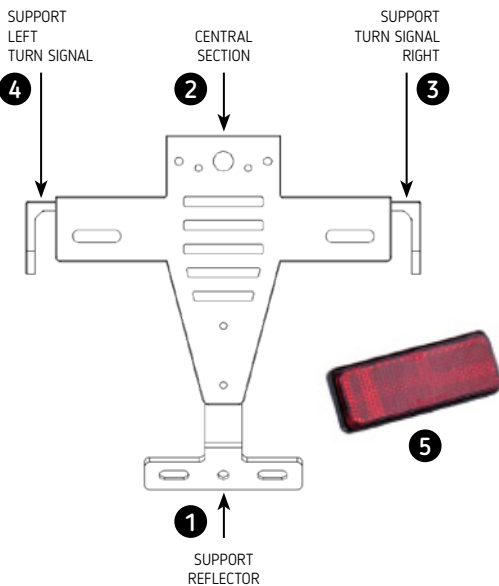

SPARES	REF.	PRICE
METALIC SUPPORT TO DISPLACE THE REFLECTOR (1)	4480I	(*)
NYLON SUPPORT TO DISPLACE THE REFLECTOR (1)	1553N	(*)
NYLON SUPPORT FOR LICENSE PLATE (2)	1558N	(*)
NYLON SUPPORT FOR TURN SIGNAL RIGHT (3)	1559N	(*)
NYLON SUPPORT FOR TURN SIGNAL LEFT (4)	1615N	(*)
REFLECTOR HOMOLOGATED DE 8,8 x 3,4 cm. C/RED (5)	4481R	(*)
REFLECTOR HOMOLOGATED DE 7,5 x 2,5 cm. C/RED (5)	5729R	(*)

LIGHTING LICENSE SUPPORT [SEE PAGE 200](#)

UNIVERSAL MODELS	ADJUSTABLE	T. SIGNAL SUPPORT	INCLUDE KIT	REF.	PRICE
UNIVERSAL	YES/NO (&)	YES ADJUST.	NO	1539N	(*)

The license support is not designed to mount the oem turn signals.
Oem connectors are not delivered to connect lighting license.

FOR SPECIFIC MODELS [SEE PAGE 194](#)

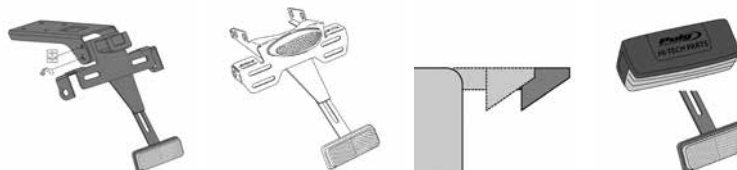

MODEL	YEAR	ADJUSTABLE	BRAKE REAR LIGHT- INCLUDED	TURN LIGHT SUPPORT	INCLUDE KIT	REF.	N
APRILIA							
RSV4	09' - 12'	YES/NO (&)	NO	YES ADJUST.	YES	4978	(*)
RSV4 FACTORY	13' - 14'	YES/NO (&)	NO	YES ADJUST.	YES	4978	(*)
RSV4 RF	15' - 18'	YES/NO (&)	NO	YES ADJUST.	YES	4978	(*)
RSV4 RR	15' - 18'	YES/NO (&)	NO	YES ADJUST.	YES	4978	(*)
TUONO V4R	11' - 14'	YES/NO (&)	NO	YES ADJUST.	YES	4978	(*)
TUONO V4RR	15' - 18'	YES/NO (&)	NO	YES ADJUST.	YES	4978	(*)
TUONO V4 1100 FACTORY	15' - 18'	YES/NO (&)	NO	YES ADJUST.	YES	4978	(*)
BMW							
C600 SPORT	12' - 15'	YES/NO (&)	NO	YES ADJUST.	YES	6061	(*)
C650 SPORT	16' - 18'	YES/NO (&)	NO	YES ADJUST.	YES	6061	(*)
R NINE T	14' - 18'	YES/NO (&)	NO	YES ADJUST.	YES	8152	(*)
R NINE T PURE	17' - 18'	YES/NO (&)	NO	YES ADJUST.	YES	8152	(*)
R NINE T SCRAMBLER	16' - 18'	YES/NO (&)	NO	YES ADJUST.	YES	8152	(*)
R1200 R	15' - 18'	YES/NO (&)	NO	YES ADJUST.	NO	8541	(*)
R1200 RS	15' - 18'	YES/NO (&)	NO	YES ADJUST.	NO	8541	(*)
S1000 R	14' - 18'	YES/NO (&)	NO	YES ADJUST.	YES	5319	(*)
S1000 RR	09' - 11'	YES/NO (&)	NO	YES ADJUST.	YES	5319	(*)
S1000 RR	12' - 18'	YES/NO (&)	NO	YES ADJUST.	YES	5319	(*)
DERBI							
GPR 125	09' - 14'	YES/NO (&)	NO	YES ADJUST.	YES	5546	(*)
DUCATI							
899 PANIGALE	14' - 15'	YES/NO (&)	NO	YES ADJUST.	YES	6099	(*)
959 PANIGALE	16' - 18'	YES/NO (&)	NO	YES ADJUST.	YES	6099	(*)
959 PANIGALE CORSE	18'	YES/NO (&)	NO	YES ADJUST.	YES	6099	(*)
1199 PANIGALE	12' - 14'	YES/NO (&)	NO	YES	YES	6099	(*)
1199 SUPERLEGGERA	14'	YES/NO (&)	NO	YES	YES	6099	(*)
1299 PANIGALE/S	15' - 17'	YES/NO (&)	NO	YES ADJUST.	YES	6099	(*)
PANIGALE V4	18'	YES/NO (&)	NO	YES ADJUST.	YES	9751	(*)
PANIGALE V4 S	18'	YES/NO (&)	NO	YES ADJUST.	YES	9751	(*)
PANIGALE V4 SPECIALE	18'	YES/NO (&)	NO	YES ADJUST.	YES	9751	(*)
MONSTER 400	02' - 06'	NO	NO	NO	NO	1771	(*)
MONSTER 620	02' - 06'	NO	NO	NO	NO	1771	(*)
MONSTER 800	03' - 04'	NO	NO	NO	NO	1771	(*)
MONSTER 1000/S	03' - 05'	NO	NO	NO	NO	1771	(*)
MONSTER S2R	05' - 07'	NO	NO	NO	NO	1771	(*)
MONSTER S4R	04' - 06'	NO	NO	NO	NO	1771	(*)
MONSTER 695	06' - 07'	NO	NO	NO	NO	1771	(*)

MODEL	YEAR	ADJUSTABLE	BRAKE REAR LIGHT- INCLUDED	TURN LIGHT SUPPORT	INCLUDE KIT	REF.	N
MONSTER 696	08' - 14'	YES/NO (&)	NO	YES	YES	4733	(*)
MONSTER 796	10' - 14'	YES/NO (&)	NO	YES	YES	4979	(*)
MONSTER 797	17' - 18'	YES/NO (&)	NO	YES	YES	9496	(*)
MONSTER 821	14' - 17'	YES/NO (&)	NO	YES ADJUST.	YES	7602	(*)
MONSTER 821	18'	YES/NO (&)	NO	YES ADJUST.	YES	9496	(*)
MONSTER 1100/S	09' - 10'	YES/NO (&)	NO	YES	YES	4979	(*)
MONSTER 1100 EVO	11' - 13'	YES/NO (&)	NO	YES	YES	4979	(*)
MONSTER 1200/S	14' - 16'	YES/NO (&)	NO	YES ADJUST.	YES	7563	(*)
MONSTER 1200/S	17' - 18'	YES/NO (&)	NO	YES ADJUST.	YES	9496	(*)
STREETFIGHTER 848	12' - 15	YES/NO (&)	NO	YES ADJUST.	YES	5320	(*)
STREETFIGHTER 1100	09' - 12'	YES/NO (&)	NO	YES ADJUST.	YES	5320	(*)
STREETFIGHTER 1100 S	09' - 13'	YES/NO (&)	NO	YES ADJUST.	YES	5320	(*)
SUPERSPORT 939/S	17' - 18'	YES/NO (&)	NO	YES ADJUST.	YES	9496	(*)
HARLEY DAVIDSON							
SPORTSTER 883 IRON	13' - 18'	NO	NO	NO	YES	9994	(*)
HONDA							
CB125R NEO SPORTS CAFE	18'	YES/NO (&)	NO	YES ADJUST.	YES	9653	(*)
CB300R NEO SPORTS CAFE	18'	YES/NO (&)	NO	YES ADJUST.	YES	9653	(*)
CMX 500 REBEL	17' - 18'	NO	YES	NO	YES - ONLY REFLECTOR	9671	(*)
CB500F	16' - 18'	YES/NO (&)	NO	YES ADJUST.	YES	8722	(*)
CB600F HORNET	11' - 16'	YES/NO (&)	NO	YES	YES	5730	(*)
CB650F	14' - 16'	YES/NO (&)	NO	YES ADJUST.	YES	7100	(*)
CB650F	17' - 18'	YES/NO (&)	NO	YES ADJUST.	YES	7100	(*)
CB1000R	08' - 16'	YES/NO (&)	NO	YES ADJUST.	NO	4732	(*)
CB1000R NEO SPORTS CAFE	18'	YES/NO (&)	NO	YES ADJUST.	YES	9786	(*)
CBR600F	11' - 13'	YES/NO (&)	NO	YES ADJUST.	YES	5730	(*)
CBR650F	14' - 16'	YES/NO (&)	NO	YES ADJUST.	YES	7100	(*)
CBR650F	17' - 18'	YES/NO (&)	NO	YES ADJUST.	YES	7100	(*)
CBR500R	16' - 18'	YES/NO (&)	NO	YES ADJUST.	YES	8722	(*)
CBR600RR	03' - 06'	NO	NO	YES	NO	1612	(*)
CBR600RR	07' - 12'	NO	YES	YES	NO	4453	(*)
CBR600RR	13' - 16'	NO	NO	YES	YES	6545	(*)
CBR1000RR FIREBLADE	04' - 07'	NO	NO	YES	NO	1766	(*)
CBR1000RR FIREBLADE	12' - 13'	YES/NO (&)	NO	YES ADJUST.	YES	6090	(*)
CBR1000RR FIREBLADE/SP/SP2	17' - 18'	YES/NO (&)	NO	YES ADJUST.	YES	9456	(*)
INTEGRA 700	12' - 13'	YES/NO (&)	YES	YES ADJUST.	YES	6089	(*)
INTEGRA 750	14' - 15'	YES/NO (&)	YES	YES ADJUST.	YES	6089	(*)
INTEGRA 750	16' - 18'	YES/NO (&)	NO	YES ADJUST.	YES	8725	(*)



N

Black

(*) Check price with your distributor.

(**) Required original piece from Yamaha ref. 15D-F1685-10.

(****) Required original piece from Yamaha ref. B74-F163A-00-00

(&) Produced not adjustable with a removable fastener.

(-) It's necessary to cut the rear fender.

#) License support+extension protector against splash for motorcycle.

IMPORTANT: Indicate code color after part#. Example: 0973A.



MODEL	YEAR	ADJUSTABLE	BRAKE REAR LIGHT- INCLUDED	TURN LIGHT SUPPORT	INCLUDE KIT	REF.	N
MSX125	14' - 15'	YES/NO (&)	NO	YES ADJUST.	YES	7552	(*)
MSX125	16' - 18'	YES/NO (&)	NO	YES ADJUST.	YES	9257	(*)
NC700S/X	12' - 13'	YES/NO (&)	YES	YES ADJUST.	YES	6089	(*)
NC750S/X	14' - 15'	YES/NO (&)	YES	YES ADJUST.	YES	6089	(*)
NC750S/X	16' - 18'	YES/NO (&)	NO	YES ADJUST.	YES	8725	(*)
SCOOPY SH125i (-)	07' - 08'	YES/NO (&)	NO	NO	NO	4847	(*)
SCOOPY SH150i (-)	07' - 08'	YES/NO (&)	NO	NO	NO	4847	(*)
X-ADV	17' - 18'	YES/NO (&)	YES	YES ADJUST.	YES	9706	(*)
INDIAN							
SCOUT BOBBER	18'	NO	NO	NO	YES	9741	(*)
KAWASAKI							
ER-6N	05' - 08'	YES/NO (&)	NO	YES	NO	4210	(*)
ER-6N	09' - 11'	YES/NO (&)	NO	YES ADJUST.	YES	4976	(*)
ER-6N	12' - 16'	YES/NO (&)	NO	YES ADJUST.	YES	6096	(*)
ER-6F	06' - 08'	YES/NO (&)	NO	YES	NO	4210	(*)
ER-6F	09' - 11'	YES/NO (&)	NO	YES ADJUST.	YES	4976	(*)
ER-6F	12' - 16'	YES/NO (&)	NO	YES ADJUST.	YES	6096	(*)
NINJA H2	15' - 18'	YES/NO (&)	NO	YES ADJUST.	YES	7787	(*)
NINJA H2 SX	18'	YES/NO (&)	NO	YES ADJUST.	YES	9707	(*)
NINJA 250SL	15' - 16'	YES/NO (&)	NO	YES ADJUST.	YES	7788	(*)
NINJA 300	13' - 17'	YES/NO (&)	NO	YES ADJUST.	YES	6546	(*)
NINJA 400	18'	YES/NO (&)	NO	YES ADJUST.	YES	9629	(*)
NINJA 650	17' - 18'	YES/NO (&)	NO	YES ADJUST.	YES	9353	(*)
VERSYS-X 300	17' - 18'	YES/NO (&)	NO	YES ADJUST.	YES	9475	(*)
VERSYS 650	10' - 14'	YES/NO (&)	NO	YES ADJUST.	YES	5318	(*)
VERSYS 650	15' - 18'	YES/NO (&)	NO	YES ADJUST.	YES	7789	(*)
VERSYS 1000	12' - 16'	YES/NO (&)	NO	YES ADJUST.	YES	6095	(*)
VERSYS 1000	17' - 18'	YES/NO (&)	NO	YES ADJUST.	YES	9450	(*)
VULCAN S	15' - 18'	YES/NO (&)	YES	YES ADJUST.	YES - ONLY REFLECTOR	9675	(*)
VULCAN S CAFE	17' - 18'	YES/NO (&)	YES	YES ADJUST.	YES - ONLY REFLECTOR	9675	(*)
Z250SL	15' - 16'	YES/NO (&)	NO	YES ADJUST.	YES	7788	(*)
Z300	15' - 17'	YES/NO (&)	NO	YES ADJUST.	YES	6546	(*)
Z650	17' - 18'	YES/NO (&)	NO	YES ADJUST.	YES	9353	(*)
Z750	04' - 06'	NO	NO	YES	NO	1607	(*)
Z750	07' - 12'	NO	NO	YES	NO	4529	(*)
Z750S	05' - 06'	NO	NO	YES	NO	1607	(*)

MODEL	YEAR	ADJUSTABLE	BRAKE REAR LIGHT- INCLUDED	TURN LIGHT SUPPORT	INCLUDE KIT	REF.	N
Z750R	11' - 12'	NO	NO	YES	NO	4529	(*)
Z800	13' - 16'	YES/NO (&)	NO	YES ADJUST.	YES	6548	(*)
Z800E	13' - 16'	YES/NO (&)	NO	YES ADJUST.	YES	6548	(*)
Z900	17' - 18'	YES/NO (&)	NO	YES ADJUST.	YES	9388	(*)
Z900RS	18'	YES/NO (&)	NO	YES ADJUST.	YES	9597	(*)
Z1000	03' - 06'	NO	NO	YES	NO	1607	(*)
Z1000	07' - 09'	NO	NO	YES	NO	4529	(*)
Z1000	10' - 13'	YES/NO (&)	NO	YES ADJUST.	YES	5317	(*)
Z1000	14' - 18'	YES/NO (&)	NO	YES ADJUST.	YES	7102	(*)
Z1000R	17' - 18'	YES/NO (&)	NO	YES ADJUST.	YES	7102	(*)
Z1000SX	11' - 16'	YES/NO (&)	NO	YES ADJUST.	YES	5735	(*)
Z1000SX	17' - 18'	YES/NO (&)	NO	YES ADJUST.	YES	5735	(*)
ZX-6R	03' - 04'	NO	NO	YES	NO	1607	(*)
ZX-6R 636	13' - 16'	YES/NO (&)	NO	YES ADJUST.	YES	6547	(*)
ZX-10R	11' - 15'	YES/NO (&)	NO	NO	YES	5736	(*)
ZX-10R	16' - 18'	YES/NO (&)	NO	YES ADJUST.	YES	8726	(*)
ZX-10RR	17' - 18'	YES/NO (&)	NO	YES ADJUST.	YES	8726	(*)
ZX-10R SE	18'	YES/NO (&)	NO	YES ADJUST.	YES	8726	(*)
ZZR1400	06' - 18'	YES/NO (&)	NO	NO	NO	4337	(*)
KTM							
125 DUKE	17' - 18'	YES/NO (&)	NO	YES ADJUST.	YES	9492	(*)
390 DUKE	17' - 18'	YES/NO (&)	NO	YES ADJUST.	YES	9492	(*)
690 DUKE	08' - 11'	YES/NO (&)	NO	YES ADJUST.	YES	5247	(*)
690 DUKE R	10' - 11'	YES/NO (&)	NO	YES ADJUST.	YES	5247	(*)
790 DUKE	18'	YES/NO (&)	NO	YES ADJUST.	YES	9683	(*)
1290 SUPERDUKE R	14' - 16'	YES/NO (&)	NO	YES ADJUST.	YES	7106	(*)
1290 SUPERDUKE R	17' - 18'	YES/NO (&)	NO	YES ADJUST.	YES	7106	(*)
1290 SUPERDUKE GT	16' - 18'	YES/NO (&)	NO	YES ADJUST.	YES	8728	(*)
690 SUPERMOTO	07' - 11'	YES/NO (&)	NO	YES ADJUST.	YES	5247	(*)
RC125/RC390	14' - 18'	YES/NO (&)	NO	YES ADJUST.	YES	7107	(*)
KYMCO							
AK 550	17' - 18'	YES/NO (&)	NO	YES ADJUST.	YES	9534	(*)
MV AGUSTA							
BRUTALE 990 RR	10' - 13'	YES/NO (&)	NO	YES ADJUST.	YES	5738	(*)
BRUTALE 1090 RR	10' - 18'	YES/NO (&)	NO	YES ADJUST.	YES	5738	(*)
SUZUKI							
DL650 V-STROM	04' - 11'	YES/NO (&)	NO	NO	YES	6272	(*)
DL650 V-STROM	12' - 16'	YES/NO (&)	NO	YES	YES	6372	(*)
DL650XT V-STROM	15' - 16'	YES/NO (&)	NO	YES	YES	6372	(*)



N
Black

(*) Check price with your distributor.
 (***) Required original piece from Yamaha ref. 15D-F1685-10.
 (****) Required original piece from Yamaha ref. B74-F163A-00-00
 (&) Produced not adjustable with a removable fastener.
 (-) It's necessary to cut the rear fender.
 (#) License support+extension protector against splash for motorcycle.

IMPORTANT: Indicate code color after part#. Example: 0973A.



MODEL	YEAR	ADJUSTABLE	BRAKE REAR LIGHT- INCLUDED	TURN LIGHT SUPPORT	INCLUDE KIT	REF.	N
GSR600 (-)	06' - 11'	NO	NO	YES	YES	4076	(*)
GSR750	11' - 16'	YES/NO (&)	NO	YES ADJUST.	YES	5734	(*)
GSX-S125	17' - 18'	YES/NO (&)	NO	YES ADJUST.	YES	9958	(*)
GSX-S750	17' - 18'	YES/NO (&)	NO	YES ADJUST.	YES	9422	(*)
GSX-S1000	15' - 18'	YES/NO (&)	NO	YES ADJUST.	YES	9422	(*)
GSX-S1000F	15' - 18'	YES/NO (&)	NO	YES ADJUST.	YES	9422	(*)
GSX-R125	17' - 18'	YES/NO (&)	NO	YES ADJUST.	YES	9958	(*)
GSX-R250	17' - 18'	YES/NO (&)	NO	YES ADJUST.	YES	9523	(*)
GSX-R600	04' - 05'	NO	NO	YES	YES	1779	(*)
GSX-R600	06' - 07'	YES/NO (&)	NO	NO	NO	4075	(*)
GSX-R600	08' - 10'	YES/NO (&)	NO	NO	YES	4735	(*)
GSX-R600	11' - 16'	YES/NO (&)	NO	NO	YES	5733	(*)
GSX-R750	04' - 05'	NO	NO	YES	YES	1779	(*)
GSX-R750	06' - 07'	YES/NO (&)	NO	NO	NO	4075	(*)
GSX-R750	08' - 10'	YES/NO (&)	NO	NO	YES	4735	(*)
GSX-R750	11' - 16'	YES/NO (&)	NO	NO	YES	5733	(*)
GSX-R1000	05' - 08'	YES/NO (&)	NO	NO	NO	2558	(*)
GSX-R1000	09' - 16'	YES/NO (&)	NO	NO	YES	4973	(*)
GSX-R1000/R	17' - 18'	YES/NO (&)	NO	YES ADJUST.	YES	9451	(*)
GSXR1300 HAYABUSA	08' - 12'	YES/NO (&)	NO	NO	YES	4817	(*)
SV650	16' - 18'	YES/NO (&)	NO	YES ADJUST.	YES	8729	(*)
SV650X	18'	YES/NO (&)	NO	YES ADJUST.	YES	8729	(*)
TRIUMPH							
DAYTONA 675/R	13' - 17'	YES/NO (&)	NO	YES ADJUST.	YES	6551	(*)
SPEED TRIPLE	11' - 15'	YES/NO (&)	NO	YES	YES	5732	(*)
SPEED TRIPLE R	12' - 15'	YES/NO (&)	NO	YES	YES	5732	(*)
SPEED TRIPLE/R	16' - 18'	YES/NO (&)	NO	YES	YES	8730	(*)
STREET TRIPLE/R	13' - 18'	YES/NO (&)	NO	YES ADJUST.	YES	6551	(*)
STREET TRIPLE S/RS	17' - 18'	YES/NO (&)	NO	YES ADJUST.	YES	6551	(*)
YAMAHA							
FZ1 FAZER	06' - 15'	NO	NO	YES ADJUST.	NO	4074	(*)
FZ6	04' - 08'	YES/NO (&)	NO	YES ADJUST.	NO	5046	(*)
FZ6 FAZER	04' - 08'	YES/NO (&)	NO	YES ADJUST.	NO	5046	(*)
FZ6 S2	07' - 10'	YES/NO (&)	NO	YES ADJUST.	NO	5046	(*)
FZ6 FAZER S2	07' - 10'	YES/NO (&)	NO	YES ADJUST.	NO	5046	(*)
MT-125	15 - 18'	YES/NO (&)	NO	YES ADJUST.	YES	7796	(*)
MT-03	16' - 18'	YES/NO (&)	NO	YES ADJUST.	YES	7799	(*)
MT-07	14' - 18'	YES/NO (&)	NO	YES ADJUST.	YES	7108	(*)

MODEL	YEAR	ADJUSTABLE	BRAKE REAR LIGHT- INCLUDED	TURN LIGHT SUPPORT	INCLUDE KIT	REF.	N
MT-07 TRACER	16' - 18'	YES/NO (&)	NO	YES ADJUST.	YES	9204	(*)
MT-09	13' - 16'	YES/NO (&)	NO	YES ADJUST.	YES	6885	(*)
MT-09	17' - 18'	YES/NO (&)	NO	YES ADJUST.	YES	9379	(*)
MT-09	17' - 18'	NO	NO	NO	YES	9394	(*)
MT-09 SP	18'	YES/NO (&)	NO	YES ADJUST.	YES	9379	(*)
MT-09 TRACER	15' - 18'	YES/NO (&)	NO	YES ADJUST.	YES	6885	(*)
MT-10	16' - 18'	YES/NO (&)	NO	YES ADJUST.	YES	8732	(*)
MT-10 SP	17' - 18'	YES/NO (&)	NO	YES ADJUST.	YES	8732	(*)
T-MAX 500 (-)	08' - 11'	YES/NO (&)	NO	NO	YES	4852	(*)
T-MAX 530	12' - 16'	YES/NO (&)	NO	NO	YES	6092	(*)
T-MAX 530 (#)	12' - 16'	YES/NO (&)	NO	NO	YES	6374	(*)
T-MAX 530/DX/SX	17' - 18'	YES/NO (&)	NO	YES ADJUST.	YES	9468	(*)
T-MAX 530/DX/SX (#)	17' - 18'	YES/NO (&)	NO	YES ADJUST.	YES	6374	(*)
XJ6	09' - 16'	YES/NO (&)	NO	YES ADJUST.	YES	4949	(*)
XJ6 DIVERSION	09' - 16'	YES/NO (&)	NO	YES ADJUST.	YES	4949	(*)
XJ6 DIVERSION F	10' - 16'	YES/NO (&)	NO	YES ADJUST.	YES	4949	(*)
X-MAX 125/250	10' - 13'	YES/NO (&)	NO	NO	YES	5316	(*)
X-MAX 125 (**)	14' - 17'	YES/NO (&)	NO	NO	YES	6993	(*)
X-MAX 125 (***)	18'	YES/NO (&)	NO	NO	YES	9494	(*)
X-MAX 250 (**)	14' - 16'	YES/NO (&)	NO	NO	YES	6993	(*)
X-MAX 300 (***)	17' - 18'	YES/NO (&)	NO	NO	YES	9494	(*)
X-MAX 400 (**)	13' - 18'	YES/NO (&)	NO	NO	YES	6993	(*)
X-MAX 400 (***)	13' - 18'	YES/NO (&)	NO	NO	YES	9994	(*)
XSR700	16' - 18'	YES/NO (&)	YES	YES ADJUST.	YES	8733	(*)
XSR900	16' - 18'	YES/NO (&)	NO	YES ADJUST.	YES	8734	(*)
YZF-R125	08' - 13'	YES/NO (&)	NO	YES ADJUST.	YES	4737	(*)
YZF-R1	02' - 03'	YES/NO (&)	NO	YES	YES	1611	(*)
YZF-R1/SP	04' - 06'	NO	NO	YES	NO	1762	(*)
YZF-R1	07' - 08'	YES/NO (&)	NO	YES	NO	4454	(*)
YZF-R1	09' - 14'	YES/NO (&)	NO	YES ADJUST.	YES	4971	(*)
YZF-R1	15' - 18'	YES/NO (&)	NO	YES ADJUST.	YES	7798	(*)
YZF-R1M	17' - 18'	YES/NO (&)	NO	YES ADJUST.	YES	7798	(*)
YZF-R3	15' - 18'	YES/NO (&)	NO	YES ADJUST.	YES	7799	(*)
YZF-R6	00' - 02'	NO	NO	YES	NO	1610	(*)
YZF-R6	03' - 05'	YES/NO (&)	NO	YES	YES	1611	(*)
YZF-R6	06' - 07'	YES/NO (&)	NO	YES	YES	4073	(*)
YZF-R6	08' - 16'	YES/NO (&)	NO	YES ADJUST.	NO	4736	(*)
YZF-R6	17' - 18'	YES/NO (&)	NO	YES ADJUST.	NO	9842	(*)



N

Black

(*) Check price with your distributor.

(**) Required original piece from Yamaha ref. 15D-F1685-10.

(***) Required original piece from Yamaha ref. B74-F163A-00-00

(&) Produced not adjustable with a removable fastener.

(-) It's necessary to cut the rear fender.

#) License support+extension protector against splash for motorcycle.

IMPORTANT: Indicate code color after part#. Example: 0973A.

/// LIGHTING LICENSE SUPPORT

HI-TECH PARTS



// PLA

HOMOLOGATED

MODEL	REF.	N
LICENSE LIGHT SUPPORT MODEL PLA WITH LEDS (45 x 20 mm.)	5577N	(*)

Made in black plastic suitable for our licence supports.



// ALU

HOMOLOGATED

MODEL	REF.	N
LICENSE LIGHT SUPPORT MODEL ALU WITH LEDS (45 x 20 mm.)	5565	(*)

Made in aluminium anodized suitable for our licence supports.



N
Black

(*) Check price with your distributor.

IMPORTANT: Indicate code color after part#. Example: 0973A.

**// RUSH****NOT HOMOLOGATED**

MODEL	REF.	P
LICENSE LIGHT SUPPORT MOD. RUSH WITH LEDS (45 x 18 mm.)	4460P	(*)

Made in aluminium anodized suitable for our licence supports.

**// TRO****HOMOLOGATED**

MODEL	REF.	N P
LICENSE LIGHT SUPPORT MOD. TRO WITH LEDS (56 x 26 mm.)	4645	(*)

Made in aluminium anodized suitable for our licence supports.

**// MIG****HOMOLOGATED**

MODEL	REF.	N
LICENSE LIGHT SUPPORT MOD. MIG WITH LEDS (56 x 26 mm.)	4646N	(*)

Made in black plastic suitable for our licence supports.

P
Natural ErgalN
Black

(*) Check price with your distributor.

IMPORTANT: Indicate code color after part#. Example: 0973A.



FUNCTION

Allow mounting the original turn signals on the Puig license supports.



MATERIAL

Made of steel.
Finished with epoxy black paint.

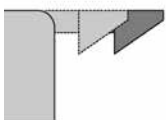

OPTICS

Hides the empty section left by the original turn signal once replaced.



SUPPORT FOR ORIGINAL TURN SIGNAL

HI-TECH PARTS

2019
 MODELS:
www.puig.tv

MODEL	YEAR	REF.	N
APRILIA			
RSV4	09' - 12'	9318N	(*)
RSV4 FACTORY	13' - 14'	9318N	(*)
RSV4 RF	15' - 18'	9318N	(*)
RSV4 RR	15' - 18'	9318N	(*)
TUONO V4R	11' - 14'	9318N	(*)
TUONO V4RR	15' - 18'	9318N	(*)
TUONO V4 1100 FACTORY	15' - 18'	9318N	(*)
BMW			
C600 SPORT	12' - 15'	9318N	(*)
C650 SPORT	16' - 18'	9318N	(*)
S1000 R	14' - 18'	9318N	(*)
S1000 RR	09' - 18'	9318N	(*)
DERBI			
GPR 125	09' - 14'	9318N	(*)
DUCATI			
MONSTER 1200/S	17' - 18'	9604N	(*)
MONSTER 797	17' - 18'	9604N	(*)
MONSTER 821	18'	9604N	(*)
PANIGALE V4	18'	9604N	(*)
PANIGALE V4 S	18'	9604N	(*)
PANIGALE V4 SPECIALE	18'	9604N	(*)
SUPERSPORT 939/S	17' - 18'	9604N	(*)
HONDA			
CB125R NEO SPORTS CAFE	18'	9457N	(*)
CB300R NEO SPORTS CAFE	18'	9457N	(*)
CB500F	16' - 18'	9327N	(*)
CB650F	14' - 18'	9327N	(*)
CB1000R	08' - 16'	9327N	(*)
CB1000R NEO SPORTS CAFE	18'	1945N	(*)
CBR500R	16' - 18'	9327N	(*)
CBR1000RR FIREBLADE	04' - 16'	9327N	(*)
CBR1000RR FIREBLADE /SP	14' - 16'	9327N	(*)
CBR1000RR FIREBLADE/SP/SP2	17' - 18'	9457N	(*)
CBR600F	11' - 13'	9327N	(*)
CBR650F	17' - 18'	9327N	(*)

MODEL	YEAR	REF.	N
CB600F HORNET	11' - 15'	9327N	(*)
CMX 500 REBEL	17' - 18'	9327N	(*)
INTEGRA 700	12' - 13'	9327N	(*)
INTEGRA 750	14' - 18'	9327N	(*)
NC700S/X	12' - 13'	9327N	(*)
NC750S/X	14' - 18'	9327N	(*)
KAWASAKI			
ER-6F	06' - 16'	9320N	(*)
ER-6N	05' - 16'	9320N	(*)
NINJA 400	18'	9320N	(*)
NINJA 650	17' - 18'	CHECK WEB	
NINJA H2 SX	18'	9320N	(*)
VERSYS-X 300	17' - 18'	9320N	(*)
VERSYS 650	10' - 18'	9320N	(*)
VERSYS 1000	12' - 18'	9320N	(*)
VULCAN S	15' - 18'	9320N	(*)
VULCAN S CAFE	17' - 18'	9320N	(*)
Z250SL	15' - 16'	9320N	(*)
Z300	15' - 17'	9320N	(*)
Z650	17' - 18'	9320N	(*)
Z750	04' - 12'	9320N	(*)
Z750R	11' - 12'	9320N	(*)
Z800/E	13' - 16'	9320N	(*)
Z900	17' - 18'	9320N	(*)
Z900RS	18'	9320N	(*)
Z1000	03' - 17'	9320N	(*)
Z1000R	17' - 18'	9320N	(*)
Z1000SX	11' - 18'	9320N	(*)
ZX-6R	09' - 16'	9320N	(*)
ZX-6R 636	13' - 16'	9320N	(*)
ZX-10R	16' - 18'	9320N	(*)
ZX-10RR	17' - 18'	9320N	(*)
KTM			
125 DUKE	17' - 18'	9324N	(*)
390 DUKE	17' - 18'	9324N	(*)
790 DUKE	18'	9324N	(*)



N
 Black

(*) Check price with your distributor.

IMPORTANT: Indicate code color after part#. Example: 0973A.

MODEL	YEAR	REF.	N
690 SUPERMOTO	07' - 11'	9324N	(*)
1290 SUPERDUKE R	14' - 18'	9324N	(*)
1290 SUPERDUKE GT	16' - 18'	9324N	(*)
RC125/RC390	14' - 18'	9324N	(*)
SUZUKI			
GSR750	11' - 16'	9325N	(*)
GSX-S125	17' - 18'	9959N	(*)
GSX-S750	17' - 18'	9325N	(*)
GSX-S1000	15' - 18'	9325N	(*)
GSX-S1000F	15' - 18'	9325N	(*)
GSX-R125	17' - 18'	9959N	(*)
GSX-R250	17' - 18'	9524N	(*)
GSX-R1000	09' - 16'	9325N	(*)
GSX-R1000/R	17' - 18'	9452N	(*)
SV650	16' - 18'	9325N	(*)
SV650X	18'	9452N	(*)
TRIUMPH			
DAYTONA 675	13' - 17'	9322N	(*)
DAYTONA 675 R	13' - 17'	9322N	(*)
STREET TRIPLE	13' - 18'	9322N	(*)
STREET TRIPLE R	13' - 18'	9322N	(*)
YAMAHA			
FAZER8	13' - 16'	9319N	(*)
FZ6	04' - 08'	9319N	(*)
FZ6 S2	07' - 10'	9319N	(*)
FZ6 FAZER	04' - 08'	9319N	(*)
FZ6 FAZER S2	07' - 10'	9319N	(*)
FZ8	10' - 16'	9319N	(*)
FZ8 FAZER	10' - 12'	9319N	(*)
FZ1	06' - 15'	9319N	(*)
FZ1 FAZER	06' - 15'	9319N	(*)
MT-03	16' - 18'	9319N	(*)
MT-07	14' - 18'	9319N	(*)
MT-07 TRACER	16' - 18'	9319N	(*)
MT-09	13' - 16'	9319N	(*)
MT-09	17' - 18'	CHECK WEB	



N
Black

MODEL	YEAR	REF.	N
MT-09 SP	18'	CHECK WEB	
MT-09 TRACER	18'	9319N	
MT-09 TRACER GT	18'	9319N	
MT-125	14' - 18'	9319N	(*)
MT-10	16' - 18'	9319N	(*)
T-MAX 530/DX/SX	17' - 18'	9319N	(*)
XJ6	09' - 16'	9319N	(*)
XSR700	16' - 18'	9319N	(*)
XSR900	16' - 18'	9319N	(*)
YZF-R125	08' - 18'	9319N	(*)
YZF-R1	09' - 14'	9319N	(*)
YZF-R1	15' - 18'	9319N	(*)
YZF-R3	15' - 18'	9319N	(*)
YZF-R6	06' - 07'	9319N	(*)
YZF-R6	08' - 18'	9319N	(*)

(*) Check price with your distributor.

IMPORTANT: Indicate code color after part#. Example: 0973A.



PUIG HI-TECH PARTS

UP



LOOKS

Improves the looks of the bike adding a touch of exclusivity.

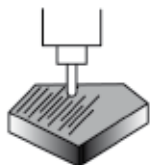

MACHINED



Machined from billet aluminium and anodized in colors.





BRAKE-CLUTCH LIQUID TANK COVER

HI-TECH PARTS

2019
MODELS:
www.puig.tv

MODEL	YEAR	BRAKE LIQUID TANK COVER		CLUTCH LIQUID TANK COVER	
BMW					
F650 GS	08' - 12'	9272	(*)		
F700 GS	12' - 17'	9272	(*)		
F750 GS	18'	9530	(*)		
F800 GT	13' - 18'	9272	(*)		
F800 GS	08' - 17'	9272	(*)		
F800R	09' - 18'	9272	(*)		
F850 GS	18'	9530	(*)		
G310R	16' - 18'	9612	(*)		
G310 GS	17' - 18'	9612	(*)		
R1200 R	15' - 18'	9273	(*)	9282	(*)
R1200 RS	15' - 18'	9273	(*)	9282	(*)
R1200 GS	13' - 18'	9273	(*)	9282	(*)
R1200GS EXCLUSIVE	17' - 18'	9273	(*)	9282	(*)
R1200GS RALLYE	17' - 18'	9273	(*)	9282	(*)
R1250GS	18'	9273	(*)	9282	(*)
R NINE T	14'	9273	(*)	9282	(*)
R NINE T (#)	15' - 16'	9273	(*)	9282	(*)
R NINE T (&)	15' - 16'	9530	(*)	9531	(*)
R NINE T	17' - 18'	9530	(*)	9531	(*)
R NINE T URBAN G/S	17' - 18'	9530	(*)	9531	(*)
R NINE T PURE	17' - 18'	9530	(*)	9531	(*)
R NINE T RACER	17' - 18'	9530	(*)	9531	(*)
S1000 R	14' - 18'	9264	(*)		
S1000 RR	09' - 14'	9264	(*)		
S1000 RR	15' - 18'	9264	(*)		
DUCATI					
HYPERMOTARD 821/SP	13' - 15'	9499	(*)		
HYPERMOTARD 939/SP	16' - 18'	9499	(*)		
HYPERSTRADA	13' - 15'	9499	(*)		
MONSTER 696	08' - 14'	9499	(*)		
MONSTER 796	10' - 14'	9499	(*)		
MONSTER 797	17' - 18'	9499	(*)		
MONSTER 821	14' - 18'	9499	(*)		
MULTISTRADA 950	17' - 18'	9499	(*)		
SCRAMBLER ICON/CLASSIC/FULL THROTTLE	15' - 18'	9499	(*)		
SCRAMBLER SIXTY2	16' - 18'	9499	(*)		
SCRAMBLER URBAN ENDURO	15' - 16'	9499	(*)		
SCRAMBLER FLAT TRACK PRO	16'	9499	(*)		
SCRAMBLER 1100	18'	9499	(*)	9540	(*)
SCRAMBLER 1100 SPORT	18'	9499	(*)	9540	(*)
SCRAMBLER 1100 SPECIAL	18'	9499	(*)	9540	(*)
HONDA					
CB125R NEO SPORTS CAFE	18'	9274	(*)		
CB300R NEO SPORTS CAFE	18'	9274	(*)		
CB500F	13' - 18'	9274	(*)		
CB500X	13' - 18'	9274	(*)		

MODEL	YEAR	BRAKE LIQUID TANK COVER		CLUTCH LIQUID TANK COVER	
CB600F HORNET	98' - 06'	9262	(*)		
CB600F HORNET	07' - 15'	9262	(*)		
CB650F	14' - 18'	9262	(*)		
CB900F HORNET	02' - 05'	9262	(*)		
CB1000R	08' - 16'	9264	(*)	9262	(*)
CB1000R NEO SPORTS CAFE	18'	9758	(*)		
CB1100	13' - 14'	9262	(*)	9262	(*)
CB1100EX	14' - 18'	9262	(*)	9262	(*)
CB1100RS	17' - 18'	9262	(*)	9262	(*)
CB1300	02' - 10'	9262	(*)	9262	(*)
CBF600/S	04' - 07'	9262	(*)		
CBF600/S	08' - 14'	9262	(*)		
CBR250R	11' - 14'	9274	(*)		
CBR500R	13' - 18'	9274	(*)		
CBR600F	86' - 07'	9262	(*)		
CBR600F	11' - 13'	9262	(*)		
CBR650F	14' - 18'	9262	(*)		
CBR600RR	07' - 09'	9264	(*)		
CBR900RR FIRE BLADE	98' - 99'	9262	(*)		
CBR1000RR FIRE BLADE	04' - 07'	9264	(*)	9262	(*)
CBR1000RR FIRE BLADE	08' - 11'	9264	(*)		
CBR1000RR FIRE BLADE	12' - 16'	9264	(*)		
CBR1000RR FIREBLADE/SP/SP2	17' - 18'	9264	(*)		
CROSSRUNNER	11' - 18'	9262	(*)	9262	(*)
CROSSTOURER	12' - 18'	9262	(*)	9262	(*)
INTEGRA 700	12' - 13'	9262	(*)	9262	(*)
INTEGRA 750	14' - 18'	9262	(*)	9262	(*)
NC700S/X	12' - 13'	9262	(*)		
NC750S/X	14' - 18'	9262	(*)		
NT700V DEAUVILLE	06' - 12'	9262	(*)		
MSX125	14' - 18'	9274	(*)		
VFR800	02' - 05'	9262	(*)	9262	(*)
VFR800F	14' - 18'	9262	(*)	9262	(*)
X-ADV	17' - 18'	9262	(*)	9262	(*)
KAWASAKI					
ER-6F	09' - 16'	9275	(*)		
ER-6N	09' - 16'	9275	(*)		
NINJA 650	17' - 18'			CHECK WEB	
NINJA H2 SX	18'	9264	(*)		
VERSYS-X 300	17' - 18'			CHECK WEB	
VERSYS 650	09' - 18'	9275	(*)		
VERSYS 1000	15' - 18'	9275	(*)		

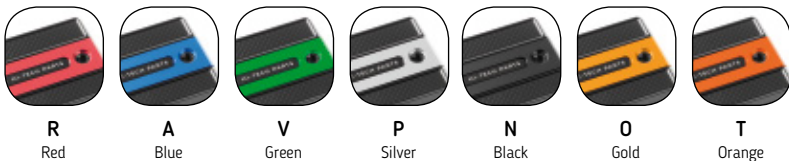



(*) Check price with your distributor.
 (#) BMW R NINE T with production code DA6, DA16
 (&) BMW R NINE T with production code DJ01, DJ03



IMPORTANT: Indicate code color after part#. Example: 0973A.

BRAKE-CLUTCH LIQUID TANK COVER

HI-TECH PARTS

2019
MODELS:
www.puig.tv

MODEL	YEAR	BRAKE LIQUID TANK COVER		CLUTCH LIQUID TANK COVER	
VULCAN S	15' - 18'	9275	(*)		
VULCAN S CAFE	17' - 18'	9275	(*)		
Z650	17' - 18'	9275	(*)		
Z800	13' - 16'	9275	(*)		
Z800E	13' - 16'	9275	(*)		
Z900	17' - 18'	9275	(*)		
Z900RS	18'	9264	(*)		
Z1000	07' - 09'	9264	(*)		
Z1000	10' - 18'	9277	(*)		
Z1000R	17' - 18'	9277	(*)		
Z1000SX	10' - 18'	9264	(*)		
ZX-6R	00' - 04'	9264	(*)		
ZX-6R	05' - 06'	9264	(*)		
ZX-6R	07' - 16'	9264	(*)		
ZX-6R 636	13' - 16'	9264	(*)		
ZX-9R	98' - 99'	9264	(*)		
ZX-9R	00' - 04'	9264	(*)		
ZX-10R	04' - 05'	9264	(*)		
ZX-10R	06' - 10'	9264	(*)		
ZX-10R	11' - 15'	9264	(*)		
KTM					
125 DUKE	17' - 18'	9612	(*)		
390 DUKE	17' - 18'	9612	(*)		
KYMCO					
AK 550	17' - 18'	9499	(*)	9540	(*)
SUZUKI					
BURGMAN 400	17' - 18'	9274	(*)	9274	(*)
DL250 V-STROM	17' - 18'	9270	(*)		
DL650 V-STROM	04' - 10'	9270	(*)		
DL650 V-STROM	11'	9270	(*)		
DL650 V-STROM	12' - 18'	9270	(*)		
DL650XT V-STROM	15' - 18'	9270	(*)		
DL1000 V-STROM	17' - 18'	9270	(*)		
DL1000XT V-STROM	17' - 18'	9270	(*)		
GSR750	11' - 16'	9270	(*)		
GSX-S125	17' - 18'	9612	(*)		
GSX-R125	17' - 18'	9612	(*)		
GSX-R250	17' - 18'	9270	(*)		
GSX-R600	96' - 03	9270	(*)		
GSX-R600	04' - 16	9264	(*)		
GSX-R750	96' - 03'	9270	(*)		
GSX-R750	04' - 16'	9264	(*)		
GSX-R1000	01' - 04'	9270	(*)		
GSX-R1000	05' - 16'	9264	(*)		
GSX-R1000/R	17' - 18'	9264	(*)		
GSX-S750	17' - 18'	9270	(*)		
INAZUMA	13' - 17'	9270	(*)		

MODEL	YEAR	BRAKE LIQUID TANK COVER		CLUTCH LIQUID TANK COVER	
SFV650 GLADIUS	09' - 15'	9270	(*)		
SV650	99' - 04'	9270	(*)		
SV650	05'	9270	(*)		
SV650	06' - 08'	9270	(*)		
SV650S	99' - 04'	9270	(*)		
SV650S	05'	9270	(*)		
SV650S	06' - 08'	9270	(*)		
SV650	16' - 18'	9270	(*)		
SV650X	18'	9264	(*)		
TRIUMPH					
DAYTONA 675	06' - 12'	9264	(*)		
DAYTONA 675	13' - 17'	9264	(*)		
SPEED TRIPLE	08' - 10'	9264	(*)		
STREET TRIPLE R	09' - 16'	9264	(*)		
YAMAHA					
FZ1	06' - 15'	9267	(*)		
FZ1 FAZER	06' - 15'	9267	(*)		
FZ6	04' - 06'	9267	(*)		
FZ6 FAZER	07' - 08'	9267	(*)		
FZ8	10' - 16'	9267	(*)		
MT-07	14' - 18'	9267	(*)		
MT-07 TRACER	16' - 18'	9267	(*)		
MT-09	13' - 16'	9267	(*)		
MT-09	17' - 18'	9267	(*)		
MT-09 SP	18'	9267	(*)		
MT-09 TRACER	15' - 18'	9267	(*)		
MT-09 TRACER GT	18'	9267	(*)		
MT-10	16' - 18'	9267	(*)		
MT-10 SP	17' - 18'	9267	(*)		
T-MAX 500	08' - 11'	9269	(*)	9269	(*)
T-MAX 530	12' - 14'	9269	(*)	9269	(*)
T-MAX 530	15' - 16'	9269	(*)	9269	(*)
T-MAX 530/DX/SX	17' - 18'	9269	(*)	9269	(*)
XJ6	09' - 16'	9267	(*)		
XJ6 DIVERSION	09' - 16'	9267	(*)		
XJ6 DIVERSION F	10' - 16'	9267	(*)		
XSR700	16' - 18'	9267	(*)		
XSR900	16' - 18'	9267	(*)		
XT660Z TÉNÉRÉ	08' - 16'	9267	(*)		
YZF-R1	04' - 16'	9264	(*)		
YZF-R6	06' - 18'	9264	(*)		

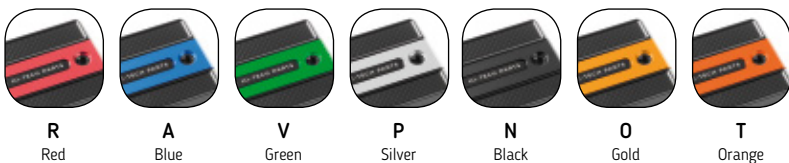

(*) Check price with your distributor.
 (#) BMW R NINE T con código de fabricación OA6, OA16
 (S) BMW R NINE T con código de fabricación OJ01, OJ03
IMPORTANT: Indicate code color after part#. Example: 0973A.



PUIG HI-TECH PARTS

ALUMINIUM FILTER COVER

HI-TECH PARTS | TECHNICAL SECTION

213

NEW!



MODEL	YEAR	REF.	N
HARLEY DAVIDSON			
SPORTSTER 883 IRON	16' - 18'	9993	(*)



N
Black

(*) Check price with your distributor.

IMPORTANT: Indicate code color after part#. Example: 0973A.





FOLDABLE MODEL 2.0	REF.	R O A T N P V
FOLDABLE BRAKE LEVER	SEE PAGE 216	(*)
ADAPTOR BRAKE LEVER	SEE PAGE 218	
FOLDABLE CLUTCH LEVER	SEE PAGE 216	(*)
ADAPTOR CLUTCH LEVER	SEE PAGE 218	
SELECTOR (SPARES)	5749	(*)
SCREW-NUT-SPACER-WASHER SPRING (SPARES)	9837	(*)



NON-FOLDABLE MODEL 2.0	REF.	R O A T N P V
UNFOLDABLE BRAKE LEVER	SEE PAGE 216	(*)
ADAPTOR BRAKE LEVER	SEE PAGE 218	
UNFOLDABLE CLUTCH LEVER	SEE PAGE 216	(*)
ADAPTOR CLUTCH LEVER	SEE PAGE 218	
SELECTOR (SPARES)	5749	(*)
SCREW-NUT-SPACER-WASHER SPRING (SPARES)	9837	(*)



SHORT MODEL 2.0	REF.	R O A T N P V
SHORT BRAKE LEVER	SEE PAGE 216	(*)
ADAPTOR BRAKE LEVER	SEE PAGE 218	
SHORT CLUTCH LEVER	SEE PAGE 216	(*)
ADAPTOR CLUTCH LEVER	SEE PAGE 218	
SELECTOR (SPARES)	5749	(*)
SCREW-NUT-SPACER-WASHER SPRING (SPARES)	9837	(*)



EXTENDABLE FOLDABLE MODEL 2.0	REF.	R O A T N P V
EXTENDABLE FOLDABLE BRAKE LEVER	SEE PAGE 216	(*)
ADAPTOR BRAKE LEVER	SEE PAGE 218	
EXTENDABLE FOLDABLE CLUTCH LEVER	SEE PAGE 216	(*)
ADAPTOR CLUTCH LEVER	SEE PAGE 218	
SELECTOR (SPARES)	5749	(*)
EXTENDABLE KIT	8983	(*)
SCREW-NUT-SPACER-WASHER SPRING (SPARES)	9837	(*)

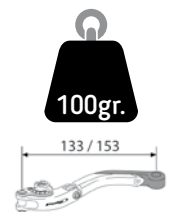

LEVERS 2.0

HI-TECH PARTS

// 5 STEPS TO FIND THE PART# FOR YOUR LEVERS 2.0

1

SELECT TYPE OF LEVER

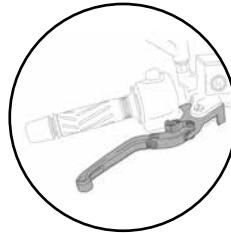

BRAKE

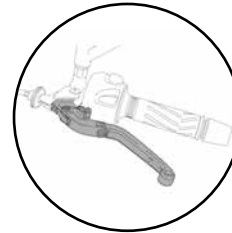

CLUTCH



2

SELECT MODEL OF LEVER 2.0



FOLDABLE

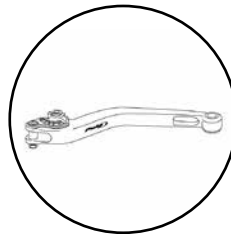

UNFOLDABLE

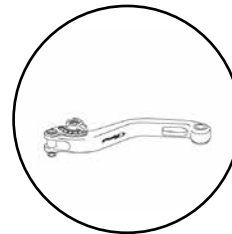

SHORT

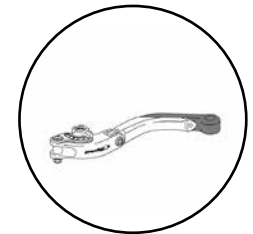

EXTENDABLE FOLDING



3

SELECT COLOUR OF EXTENDABLE



ALWAYS ZERO



SELECT COLOUR OF EXTENDABLE

4

SELECT COLOUR OF LEVER



COLOUR OF LEVER



5

SELECT COLOUR OF SELECTOR

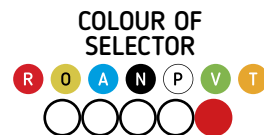

COLOUR OF SELECTOR

// EXAMPLES ON HOW TO OBTAIN THE PART# FOR THE 2.0 LEVERS



REF. 190NO

- 1** BRAKE
- 9** FOLDABLE EXTENDABLE
- 0** COLOR OF EXTENDABLE
- N** ALWAYS BLACK
- 0** COLOR SELECTOR



REF. 270AV

- 2** CLUTCH
- 7** UNFOLDABLE
- 0** ALWAYS ZERO
- A** COLOR LEVER
- V** COLOR SELECTOR



REF. 160RP

- 1** BRAKE
- 6** FOLDABLE
- 0** ALWAYS ZERO
- R** COLOR LEVER
- P** COLOR SELECTOR



REF. 280NR

- 2** CLUTCH
- 8** SHORT
- 0** ALWAYS ZERO
- N** COLOR LEVER
- R** COLOR SELECTOR



MODEL	YEAR	ADAPTOR CLUTCH LEVER	N	ADAPTOR BRAKE LEVER	N
APRILIA					
DORSODURO 900	17' - 18'	6140N	(*)	6144N	(*)
RSV4	09' - 12'	8503N	(*)	6141N	(*)
RSV4 FACTORY	13' - 14'	8503N	(*)	6141N	(*)
RSV4 RF	15' - 18'	8503N	(*)	6141N	(*)
RSV4 RR	15' - 18'	8503N	(*)	6141N	(*)
TUONO V4R	11' - 14'	8503N	(*)	6578N	(*)
TUONO V4 1100 RR	15' - 16'	8503N	(*)	6578N	(*)
TUONO V4 1100 RR	17' - 18'	8503N	(*)	6141N	(*)
TUONO V4 1100 FACTORY	15' - 16'	8503N	(*)	6578N	(*)
TUONO V4 1100 FACTORY	17' - 18'	8503N	(*)	6141N	(*)
SHIVER 750	07' - 16'	6140N	(*)	6144N	(*)
SHIVER 900	17' - 18'	6140N	(*)	6144N	(*)
BENELLI					
LEONCINO 500	16' - 18'	9695N	(*)	9694N	(*)
TRK 502	16' - 18'	9695N	(*)	9694N	(*)
BMW					
C600 SPORT	12' - 15'	6358N (rear brake)	(*)	6356N (front brake)	(*)
C650 SPORT	16' - 18'	6358N (rear brake)	(*)	6356N (front brake)	(*)
C650 GT	12' - 15'	6358N (rear brake)	(*)	6356N (front brake)	(*)
C650 GT	16' - 18'	6358N (rear brake)	(*)	6356N (front brake)	(*)
F650 GS	08' - 12'	6585N	(*)	6142N	(*)
F700 GS	12' - 17'	6585N	(*)	6142N	(*)
F750GS	18'	9783N	(*)	7839N	(*)
F800 GT	13' - 18'	6585N	(*)	6142N	(*)
F800 GS	08' - 17'	6585N	(*)	6142N	(*)
F800R	09' - 18'	6585N	(*)	6142N	(*)
F850 GS	18'	9783N	(*)	7839N	(*)
G310 GS	17' - 18'	8609N	(*)	6143N	(*)
G310 R	16' - 18'	8609N	(*)	6143N	(*)
G650 GS	11' - 16'	6139N	(*)	6143N	(*)
R1200 R	06' - 14'	6137N	(*)	6142N	(*)
R1200 R	15' - 18'	6581N	(*)	6582N	(*)
R1200 RS	15' - 18'	6581N	(*)	6582N	(*)
R1200 GS	04' - 07'	6330N	(*)	6142N	(*)
R1200 GS	08' - 12'	6137N	(*)	6142N	(*)
R1200 GS	13' - 18'	6581N	(*)	6582N	(*)
R1200GS EXCLUSIVE	17' - 18'	6581N	(*)	6582N	(*)
R1200GS RALLYE	17' - 18'	6581N	(*)	6582N	(*)
R1200 GS ADVENTURE	07' - 13'	6137N	(*)	6142N	(*)
R1250 GS	18'	6137N	(*)	6142N	(*)
R NINE T	14'	6581N	(*)	6582N	(*)

MODEL	YEAR	ADAPTOR CLUTCH LEVER	N	ADAPTOR BRAKE LEVER	N
R NINE T (#)	15' - 16'	6581N	(*)	6582N	(*)
R NINE T (&)	15' - 16'	8618N	(*)	7839N	(*)
R NINE T	17' - 18'	8618N	(*)	7839N	(*)
R NINE T SCRAMBLER	16' - 18'	8618N	(*)	7839N	(*)
R NINE T PURE	17' - 18'	8618N	(*)	7839N	(*)
R NINE T RACER	17' - 18'	8618N	(*)	7839N	(*)
R NINE T URBAN G/S	17' - 18'	8618N	(*)	7839N	(*)
S1000 R	14' - 18'	7171N	(*)	5458N	(*)
S1000 RR	09' - 14'	5750N	(*)	5458N	(*)
S1000 RR	15' - 18'	7171N	(*)	5458N	(*)
S1000 XR	15' - 18'	7808N	(*)	7839N	(*)
DUCATI					
749S	03' - 06'	6138N	(*)	6141N	(*)
749R	03' - 06'	6138N	(*)	6141N	(*)
848	08' - 10'	6138N	(*)	6141N	(*)
899 PANIGALE	14' - 15'	6138N	(*)	6141N	(*)
959 PANIGALE	16' - 18'	6138N	(*)	6141N	(*)
959 PANIGALE CORSE	18'	6138N	(*)	6141N	(*)
999S	05' - 06'	6138N	(*)	6141N	(*)
999R	05' - 06'	6138N	(*)	6141N	(*)
1098	07' - 08'	6138N	(*)	6141N	(*)
1198	09' - 11'	6138N	(*)	6141N	(*)
1198S	09' - 11'	6138N	(*)	6141N	(*)
1199 PANIGALE	12' - 14'	6138N	(*)	6141N	(*)
1199 SUPERLEGGERA	14'	6138N	(*)	6141N	(*)
1299 PANIGALE/S	15' - 17'	6138N	(*)	6141N	(*)
DIAVEL	11' - 18'	6138N	(*)	6141N	(*)
X DIAVEL/S	16' - 18'	6138N	(*)	6141N	(*)
HYPERMOTARD 821	13' - 15'	6590N	(*)	5444N	(*)
HYPERMOTARD 821 SP	13' - 15'	6590N	(*)	7980N	(*)
HYPERMOTARD 939	16' - 18'	6590N	(*)	5444N	(*)
HYPERMOTARD 939 SP	16' - 18'	6590N	(*)	7980N	(*)
HYPERSTRADA	13' - 15'	6590N	(*)	5444N	(*)
HYPERSTRADA 939	16' - 17'	9138N	(*)	8743N	(*)
MONSTER 696	08' - 14'	5443N	(*)	5444N	(*)
MONSTER 796	10' - 14'	5443N	(*)	5444N	(*)
MONSTER 797	17' - 18'	6590N	(*)	5444N	(*)
MONSTER 821	14' - 18'	6590N	(*)	5444N	(*)
MONSTER 1100	09' - 10'	6138N	(*)	6141N	(*)
MONSTER 1100 EVO	11' - 13'	6138N	(*)	6141N	(*)



N

Black

(*) Check price with your distributor.

(#) With production code WB10J01 from now on.

(#) BMW R NINE T with production code DA6, DA16

(&) BMW R NINE T with production code OJ01, OJ03

IMPORTANT: Indicate code color after part#. Example: 0973A.



MODEL	YEAR	ADAPTOR CLUTCH LEVER	N	ADAPTOR BRAKE LEVER	N
MONSTER 1200/S	14' - 16'	6138N	(*)	6141N	(*)
MONSTER 1200/S	17' - 18'	6138N	(*)	6141N	(*)
MONSTER 1200 R	16' - 18'	6138N	(*)	6141N	(*)
MULTISTRADA 950	17' - 18'	6590N	(*)	5444N	(*)
MULTISTRADA 1200/S	10' - 17'	6138N	(*)	6141N	(*)
MULTISTRADA 1200 PIKES PEAK	16' - 17'	6138N	(*)	6141N	(*)
MULTISTRADA 1200 ENDURO	16' - 18'	8637N	(*)	8745N	(*)
MULTISTRADA 1260/S/S DJAIR	18'	6138N	(*)	6141N	(*)
MULTISTRADA 1260 PIKES PEAK	18'	6138N	(*)	6141N	(*)
SCRAMBLER ICON/CLASSIC/FULL THROTTLE	15' - 18'	6590N	(*)	5444N	(*)
SCRAMBLER SIXTY2	16' - 18'	6590N	(*)	5444N	(*)
SCRAMBLER URBAN ENDURO	15' - 16'	6590N	(*)	5444N	(*)
SCRAMBLER FLAT TRACK PRO	16'	6590N	(*)	5444N	(*)
SCRAMBLER DESERT SLED	17' - 18'	6590N	(*)	5444N	(*)
SCRAMBLER CAFE RACER	17' - 18'	6590N	(*)	7980N	(*)
SCRAMBLER 1100	18'	5443N	(*)	5444N	(*)
SCRAMBLER 1100 SPORT	18'	5443N	(*)	5444N	(*)
SCRAMBLER 1100 SPECIAL	18'	5443N	(*)	5444N	(*)
STREETFIGHTER 848	12' - 15'	6138N	(*)	6141N	(*)
STREETFIGHTER 1100	09' - 12'	6138N	(*)	6141N	(*)
STREETFIGHTER 1100 S	09' - 13'	6138N	(*)	6141N	(*)
SUPERSPORT 939/S	17' - 18'	6590N	(*)	6141N	(*)
HONDA					
CB125R NEO SPORTS CAFE	18'	6115N	(*)	6604N	(*)
CB300R NEO SPORTS CAFE	18'	6115N	(*)	6604N	(*)
CB1000R NEO SPORTS CAFE	18'	9505N	(*)	5448N	(*)
CB500F	13' - 18'	6115N	(*)	6604N	(*)
CB500X	13' - 18'	6115N	(*)	6604N	(*)
CB600F HORNET	98' - 06'	5450N	(*)	5446N	(*)
CB600F HORNET	07' - 15'	5929N	(*)	5446N	(*)
CB650F	14' - 16'	9744N	(*)	5446N	(*)
CB650F	17' - 18'	9744N	(*)	5446N	(*)
CB900F HORNET	02' - 05'	5450N	(*)	5446N	(*)
CB1000R	08' - 16'	5449N	(*)	5448N	(*)
CB1100	13' - 14'	5449N	(*)	5446N	(*)
CB1100RS	17' - 18'	5449N	(*)	5446N	(*)
CB1100EX	17' - 18'	5449N	(*)	5446N	(*)
CB1300	03' - 10'	5449N	(*)	5446N	(*)
CB1300 ABS	03' - 10'	5449N	(*)	5446N	(*)
CBF600/S	04' - 07'	5450N	(*)	5446N	(*)
CBF600/S	08' - 14'	5929N	(*)	5446N	(*)
CBR250R	11' - 15'	6115N	(*)	6604N	(*)

MODEL	YEAR	ADAPTOR CLUTCH LEVER	N	ADAPTOR BRAKE LEVER	N
CBR500R	13' - 18'	6115N	(*)	6604N	(*)
CBR600F	86' - 07'	5450N	(*)	5446N	(*)
CBR600F	11' - 13'	5929N	(*)	5446N	(*)
CBR650F	14' - 16'	9744N	(*)	5446N	(*)
CBR650F	17' - 18'	9744N	(*)	5446N	(*)
CBR600RR	03' - 06'	5445N	(*)	5447N	(*)
CBR600RR	07' - 16'	5445N	(*)	5448N	(*)
CBR900RR FIRE BLADE	96' - 99'	5450N	(*)	5446N	(*)
CBR900RR FIRE BLADE	00' - 01'	5450N	(*)	5447N	(*)
CBR900RR FIRE BLADE	02' - 03'	5445N	(*)	5447N	(*)
CBR1000RR FIREBLADE	04' - 07'	5449N	(*)	5448N	(*)
CBR1000RR FIREBLADE	08' - 11'	5445N	(*)	5448N	(*)
CBR1000RR FIREBLADE	12' - 13'	5445N	(*)	5448N	(*)
CBR1000RR FIREBLADE/SP	14' - 16'	5445N	(*)	5448N	(*)
CBR1000RR FIREBLADE/SP/SP2	17' - 18'	9505N	(*)	5448N	(*)
CRF1000L AFRICA TWIN	16' - 18'	8657N	(*)	5446N	(*)
CROSSRUNNER	11' - 14'	5449N	(*)	5446N	(*)
CROSSRUNNER	15' - 18'	5449N	(*)	5446N	(*)
CROSSTOURER	12' - 18'	5449N	(*)	5446N	(*)
INTEGRA 700	12' - 13'	6118N (rear brake)	(*)	5446N (front brake)	(*)
INTEGRA 750	14' - 15'	6118N (rear brake)	(*)	5446N (front brake)	(*)
INTEGRA 750	16' - 18'	6118N (rear brake)	(*)	5446N (front brake)	(*)
NC700S/X	12' - 13'	6115N	(*)	5446N	(*)
NC750S/X	14' - 15'	6115N	(*)	5446N	(*)
NC750S/X	16' - 18'	9744N	(*)	5446N	(*)
NT700V DEAUVILLE	06' - 12'	5450N	(*)	5446N	(*)
MSX125	14' - 18'	6115N	(*)	6604N	(*)
VFR800	02' - 05'	5449N	(*)	5446N	(*)
VFR800F	14' - 18'	5449N	(*)	5446N	(*)
VTR1000 SP-1	00' - 02'	5449N	(*)	5447N	(*)
VTR1000 SP-2	02' - 05'	5449N	(*)	5447N	(*)
VFR1200F	10' - 16'	5449N	(*)	6879N	(*)
X-ADV	17' - 18'	6118N (rear brake)	(*)	5446N (front brake)	(*)
KAWASAKI					
ER-5	04' - 05'	5454N	(*)	5455N	(*)
ER-6F	06' - 08'	5454N	(*)	5455N	(*)
ER-6F	09' - 16'	5454N	(*)	5831N	(*)
ER-6N	06' - 08'	5454N	(*)	5455N	(*)
ER-6N	09' - 16'	5454N	(*)	5831N	(*)
GPZ500S	90' - 95'	5454N	(*)	5455N	(*)



N

Black

(*) Check price with your distributor.

(#) With production code WB10J01 from now on.

(#) BMW R NINE T with production code 0A6, 0A16

(&) BMW R NINE T with production code 0J01, 0J03

IMPORTANT: Indicate code color after part#. Example: 0973A.



MODEL	YEAR	ADAPTOR CLUTCH LEVER	N	ADAPTOR BRAKE LEVER	N
J125	15' - 18'	9396N (rear brake)	(*)	9395N (front brake)	(*)
J300	13' - 16'	9396N (rear brake)	(*)	9395N (front brake)	(*)
KLE500	91' - 97'	5454N	(*)	5455N	(*)
NINJA H2	15' - 18'	6138N	(*)	6141N	(*)
NINJA 250R	08' - 12'	5753N	(*)	5754N	(*)
NINJA 250SL	15' - 16'	5753N	(*)	5754N	(*)
NINJA 300	13' - 17'	5753N	(*)	5754N	(*)
NINJA 400	18'	5753N	(*)	5754N	(*)
NINJA 650	17' - 18'	5454N	(*)	6609N	(*)
VERSYS-X 300	17' - 18'	5753N	(*)	5754N	(*)
VERSYS 650	06' - 08'	5454N	(*)	5455N	(*)
VERSYS 650	09' - 14'	5454N	(*)	5831N	(*)
VERSYS 650	15' - 18'	5454N	(*)	6609N	(*)
VERSYS 1000	12' - 14'	5451N	(*)	5455N	(*)
VERSYS 1000	15' - 18'	5454N	(*)	6609N	(*)
VULCAN S	15' - 18'	5454N	(*)	6609N	(*)
VULCAN S CAFE	17' - 18'	5454N	(*)	6609N	(*)
Z125	17' - 18'	5753N	(*)	5754N	(*)
Z250SL	15' - 16'	5753N	(*)	5754N	(*)
Z300	15' - 17'	5753N	(*)	5754N	(*)
Z650	17' - 18'	5454N	(*)	6609N	(*)
Z750	04' - 06'	5454N	(*)	5455N	(*)
Z750	07' - 12'	5451N	(*)	5453N	(*)
Z750R	11' - 12'	5451N	(*)	5452N	(*)
Z800	13' - 16'	5451N	(*)	6609N	(*)
Z800E	13' - 16'	5451N	(*)	6609N	(*)
Z900	17' - 18'	5454N	(*)	6609N	(*)
Z900RS	18'	5454N	(*)	5452N	(*)
Z1000	03' - 06'	5451N	(*)	5455N	(*)
Z1000	07' - 13'	5451N	(*)	5452N	(*)
Z1000	14' - 16'	5451N	(*)	5452N	(*)
Z1000/R	17' - 18'	5454N	(*)	5452N	(*)
Z1000SX	11' - 18'	5451N	(*)	5452N	(*)
ZEPHYR 750	91' - 99'	5454N	(*)	5455N	(*)
ZR7	99' - 03'	5454N	(*)	5455N	(*)
ZR7S	01' - 03'	5454N	(*)	5455N	(*)
ZX-6R	94' - 99'	5454N	(*)	5455N	(*)
ZX-6R	00' - 04'	5451N	(*)	5455N	(*)
ZX-6R	05' - 06'	5451N	(*)	5458N	(*)
ZX-6R	07' - 16'	5451N	(*)	5452N	(*)
ZX-6R 636	13' - 16'	5451N	(*)	5452N	(*)
ZX-9R	98' - 99'	5454N	(*)	5455N	(*)

MODEL	YEAR	ADAPTOR CLUTCH LEVER	N	ADAPTOR BRAKE LEVER	N
ZX-9R	00' - 04'	5451N	(*)	5455N	(*)
ZX-10R	04' - 05'	5451N	(*)	5455N	(*)
ZX-10R	06' - 10'	5451N	(*)	5452N	(*)
ZX-10R	11' - 15'	5451N	(*)	5452N	(*)
ZX-10R	16' - 18'	5451N	(*)	6141N	(*)
ZX-10RR	17' - 18'	5451N	(*)	6141N	(*)
ZX-10R SE	18'	5451N	(*)	6141N	(*)
ZX-12R	00' - 06'	5451N	(*)	5455N	(*)
ZZR600	93' - 06'	5454N	(*)	5455N	(*)
ZZR1400	12' - 18'	6126N	(*)	5452N	(*)
ZZR1400S	16' - 18'	6126N	(*)	6141N	(*)
KTM					
125 DUKE	14' - 16'	7727N	(*)	7728N	(*)
125 DUKE	17' - 18'	7727N	(*)	9511N	(*)
200 DUKE	12' - 15'	7727N	(*)	7728N	(*)
390 DUKE	13' - 16'	7727N	(*)	7728N	(*)
390 DUKE	17' - 18'	7727N	(*)	9511N	(*)
690 DUKE	14' - 18'	9185N	(*)	5444N	(*)
690 DUKE R	14 - 17'	9185N	(*)	6141N	(*)
790 DUKE	18'	9686N	(*)	9688N	(*)
RC125	14' - 16'	7727N	(*)	7728N	(*)
RC125	17' - 18'	7727N	(*)	9511N	(*)
RC200	14'	7727N	(*)	7728N	(*)
RC390	14' - 16'	7727N	(*)	7728N	(*)
RC390	17' - 18'	7727N	(*)	9511N	(*)
KYMCO					
AK550	17' - 18'	9811N (rear brake)	(*)	9811N (front brake)	(*)
DOWNTOWN 125i	09' - 14'	9396N (rear brake)	(*)	9395N (front brake)	(*)
DOWNTOWN 300i	09' - 14'	9396N (rear brake)	(*)	9395N (front brake)	(*)
G-DINK 50	12' - 18'	9396N (rear brake)	(*)	9395N (front brake)	(*)
G-DINK 125i	12' - 18'	9396N (rear brake)	(*)	9395N (front brake)	(*)
G-DINK 300i	12' - 18'	9396N (rear brake)	(*)	9395N (front brake)	(*)
K-XCT 125i	13' - 16'	9396N (rear brake)	(*)	9395N (front brake)	(*)
K-XCT 300i	13' - 16'	9396N (rear brake)	(*)	9395N (front brake)	(*)
NEW DOWNTOWN 125i	15' - 18'	9396N (rear brake)	(*)	9395N (front brake)	(*)
NEW DOWNTOWN 350i	15' - 18'	9396N (rear brake)	(*)	9395N (front brake)	(*)
SUPERDINK 125i	09' - 18'	9396N (rear brake)	(*)	9395N (front brake)	(*)
SUPERDINK 350i	09' - 18'	9396N (rear brake)	(*)	9395N (front brake)	(*)
XCITING 400i	14' - 18'	9396N (rear brake)	(*)	9395N (front brake)	(*)
YAGER GT 125i	13' - 18'	9396N (rear brake)	(*)	9395N (front brake)	(*)

**N**

Black

(*) Check price with your distributor.

(#) With production code WB10J01 from now on.

(#) BMW R NINE T with production code 0A6, 0A16

(&) BMW R NINE T with production code 0J01, 0J03

IMPORTANT: Indicate code color after part#. Example: 0973A.



MODEL	YEAR	ADAPTOR CLUTCH LEVER	N	ADAPTOR BRAKE LEVER	N
YAGER GT 300i	13' - 18'	9396N (rear brake)	(*)	9395N (front brake)	(*)
SUZUKI					
B-KING	08' - 11'	5880N	(*)	5458N	(*)
DL250 V-STROM	17' - 18'	5765N	(*)	5455N	(*)
DL650 V-STROM	04' - 10'	6254N	(*)	5455N	(*)
DL650 V-STROM	11'	5927N	(*)	5455N	(*)
DL650 V-STROM	12' - 18'	5926N	(*)	5455N	(*)
DL650XT V-STROM	15' - 18'	5926N	(*)	5455N	(*)
DL1000 V-STROM	02' - 07'	5459N	(*)	5455N	(*)
DL1000 V-STROM	14' - 18'	5459N	(*)	5455N	(*)
DL1000XT V-STROM	17' - 18'	5459N	(*)	5455N	(*)
GSF650 BANDIT	07' - 11'	5459N	(*)	5455N	(*)
GSF650S BANDIT	07' - 14'	5459N	(*)	5455N	(*)
GSF1200 BANDIT	01' - 06'	5459N	(*)	5455N	(*)
GSF1250 BANDIT	07' - 13'	5459N	(*)	5455N	(*)
GSF1250S BANDIT	07' - 13'	5459N	(*)	5455N	(*)
GSF1250S BANDIT	15' - 16'	5459N	(*)	5455N	(*)
GSR600	06' - 11'	5456N	(*)	5455N	(*)
GSR750	11' - 16'	5456N	(*)	5455N	(*)
GSX-S125	17' - 18'	9961N	(*)	9962N	(*)
GSX-S750	17' - 18'	5765N	(*)	5455N	(*)
GSX650F	08' - 17'	5459N	(*)	5455N	(*)
GSX1250F	10' - 17'	5459N	(*)	5455N	(*)
GSX1400	01' - 06'	5459N	(*)	5455N	(*)
GSX-R125	17' - 18'	9961N	(*)	9962N	(*)
GSX-R250	17' - 18'	5765N	(*)	5455N	(*)
GSX-R600	96' - 03'	5456N	(*)	5455N	(*)
GSX-R600	04' - 05'	5456N	(*)	5458N	(*)
GSX-R600	06' - 10'	5457N	(*)	5458N	(*)
GSX-R600	11' - 16'	5766N	(*)	5458N	(*)
GSX-R750	96' - 03'	5456N	(*)	5455N	(*)
GSX-R750	04' - 05'	5456N	(*)	5458N	(*)
GSX-R750	06' - 10'	5457N	(*)	5458N	(*)
GSX-R750	11' - 16'	5766N	(*)	5458N	(*)
GSX-R1000	01' - 04'	5456N	(*)	5455N	(*)
GSX-R1000	05' - 06'	5457N	(*)	5458N	(*)
GSX-R1000	07' - 08'	5459N	(*)	5458N	(*)
GSX-R1000	09' - 16'	5766N	(*)	5458N	(*)
GSX-R1000/R	17' - 18'	5766N	(*)	5458N	(*)
GSX-S1000	15' - 18'	5766N	(*)	5458N	(*)
GSX-S1000F	15' - 18'	5766N	(*)	5458N	(*)
GSX-R1300 HAYABUSA	99' - 07'	5459N	(*)	5455N	(*)

MODEL	YEAR	ADAPTOR CLUTCH LEVER	N	ADAPTOR BRAKE LEVER	N
INAZUMA	13' - 17'	5765N	(*)	5455N	(*)
SFV650 GLADIUS	09' - 15'	5765N	(*)	5455N	(*)
SV650	99' - 04'	6254N	(*)	5455N	(*)
SV650	05'	6254N	(*)	5455N	(*)
SV650	06' - 08'	6254N	(*)	5455N	(*)
SV650S	99' - 04'	6254N	(*)	5455N	(*)
SV650S	05'	6254N	(*)	5455N	(*)
SV650S	06' - 08'	6254N	(*)	5455N	(*)
SV650	16' - 18'	5765N	(*)	5455N	(*)
SV650X	18'	5765N	(*)	5455N	(*)
SV1000	03' - 07'	5459N	(*)	5455N	(*)
SV1000S	03' - 07'	5459N	(*)	5455N	(*)
TRIUMPH					
BONNEVILLE T100	05' - 16'	5767N	(*)	5455N	(*)
BONNEVILLE T100	17' - 18'	7826N	(*)	5455N	(*)
BONNEVILLE T120	16' - 18'	7826N	(*)	5455N	(*)
DAYTONA 600	03' - 04'	5767N	(*)	5455N	(*)
DAYTONA 650	05'	5767N	(*)	5455N	(*)
DAYTONA 675	06' - 12'	5767N	(*)	5458N	(*)
DAYTONA 675	13' - 17'	5767N	(*)	5458N	(*)
DAYTONA 675 R	13' - 17'	5767N	(*)	6141N	(*)
DAYTONA 955i	04' - 06'	5767N	(*)	5455N	(*)
ROCKET III	04' - 09'	5767N	(*)	5455N	(*)
ROCKET III CLASSIC	06' - 09'	5767N	(*)	5455N	(*)
ROCKET III ROADSTER	10' - 17'	5767N	(*)	5455N	(*)
ROCKET III TOURING	08' - 17'	5767N	(*)	5455N	(*)
SCRAMBLER	06' - 13'	5767N	(*)	5455N	(*)
SPEED FOUR	04' - 05'	5767N	(*)	5455N	(*)
SPEEDMASTER	05' - 17'	5767N	(*)	5455N	(*)
SPEED TRIPLE axial.	05' - 07'	5767N	(*)	5455N	(*)
SPEED TRIPLE radial.	08' - 10'	5767N	(*)	5458N	(*)
SPEED TRIPLE	11' - 15'	5767N	(*)	6141N	(*)
SPEED TRIPLE R	12' - 15'	5767N	(*)	6141N	(*)
SPEED TRIPLE/R	16' - 18'	7826N	(*)	6141N	(*)
SPRINT ST 1050	05' - 10'	5767N	(*)	5455N	(*)
STREET CUP	17' - 18'	7826N	(*)	5455N	(*)
STREET SCRAMBLER	17' - 18'	7826N	(*)	5455N	(*)
STREET TRIPLE	08' - 16'	5767N	(*)	5455N	(*)
STREET TRIPLE R	09' - 16'	5767N	(*)	5458N	(*)
STREET TRIPLE/R	17' - 18'	7826N	(*)	6141N	(*)



N

Black

(*) Check price with your distributor.

(#) With production code WB10J01 from now on.

(#) BMW R NINE T with production code DA6, DA16

(&) BMW R NINE T with production code OJ01, OJ03

IMPORTANT: Indicate code color after part#. Example: 0973A.



MODEL	YEAR	ADAPTOR CLUTCH LEVER	N	ADAPTOR BRAKE LEVER	N
STREET TRIPLE S	17' - 18'	7826N	(*)	5455N	(*)
STREET TWIN	16' - 18'	7826N	(*)	5455N	(*)
THRUXTON	04' - 15'	5767N	(*)	5455N	(*)
THRUXTON 1200	16' - 18'	7826N	(*)	5455N	(*)
THRUXTON 1200 R	16' - 18'	7826N	(*)	6141N	(*)
TIGER 800	11' - 14'	5767N	(*)	5455N	(*)
TIGER 800 XC	11' - 14'	5767N	(*)	5455N	(*)
TIGER 800 XC/XCX/XCA	15' - 18'	7826N	(*)	5455N	(*)
TIGER 800 XR/XRX/XRT	15' - 18'	7826N	(*)	5455N	(*)
TIGER 1050	07' - 13'	5767N	(*)	5455N	(*)
TIGER SPORT	13' - 16'	5767N	(*)	5455N	(*)
TIGER SPORT	17' - 18'	7826N	(*)	5455N	(*)
TIGER EXPLORER	12' - 15'	6620N	(*)	5455N	(*)
TIGER EXPLORER XC	13' - 15'	6620N	(*)	5455N	(*)
TIGER EXPLORER XC/XR/XRX/XRT/XCX/XCA	16' - 18'	6620N	(*)	5455N	(*)
YAMAHA					
FJR1300	01' - 02'	5465N	(*)	5455N	(*)
FJR1300	03' - 05'	5465N	(*)	5462N	(*)
FJR1300A/AS	06' - 12'	5465N	(*)	5462N	(*)
FJR1300A/AS	13' - 18'	5465N	(*)	5462N	(*)
FZ1	06' - 15'	8503N	(*)	5462N	(*)
FZ1 FAZER	06' - 15'	8503N	(*)	5462N	(*)
FZ6	04' - 06'	8503N	(*)	5462N	(*)
FZ6 S2	07' - 10'	8503N	(*)	5462N	(*)
FZ6 FAZER	07' - 08'	8503N	(*)	5462N	(*)
FZ6 FAZER S2	07' - 10'	8503N	(*)	5462N	(*)
FZ8	10' - 16'	8503N	(*)	5462N	(*)
FZ8 FAZER	10' - 12'	8503N	(*)	5462N	(*)
FAZER8	13' - 16'	8503N	(*)	5462N	(*)
FZS1000 FAZER	01' - 05'	8503N	(*)	5455N	(*)
MT-01	05' - 13'	5465N	(*)	5464N	(*)
MT-125	14' - 18'	6120N	(*)	7582N	(*)
MT-03	16' - 18'	7830N	(*)	7861N	(*)
MT-07	14' - 18'	8503N	(*)	5462N	(*)
MT-07 TRACER	16' - 18'	8503N	(*)	5462N	(*)
MT-09	13' - 16'	8503N	(*)	5462N	(*)
MT-09	17' - 18'	8503N	(*)	5462N	(*)
MT-09 SP	18'	8503N	(*)	5462N	(*)
MT-09 TRACER	15' - 18'	8122N	(*)	5462N	(*)
MT-09 TRACER GT	18'	8122N	(*)	5462N	(*)
MT-10	16' - 18'	8873N	(*)	5462N	(*)
MT-10 SP	17' - 18'	8873N	(*)	5462N	(*)

MODEL	YEAR	ADAPTOR CLUTCH LEVER	N	ADAPTOR BRAKE LEVER	N
T-MAX 500	08' - 11'	5976N (rear brake)	(*)	5462N (front brake)	(*)
T-MAX 530	12' - 14'	5976N (rear brake)	(*)	5462N (front brake)	(*)
T-MAX 530	15' - 16'	5976N (rear brake)	(*)	5462N (front brake)	(*)
T-MAX 530/DX/SX	17' - 18'	5976N (rear brake)	(*)	5462N (front brake)	(*)
VMAX Bomba Nisin	09' - 18'	5465N	(*)	5464N	(*)
X-MAX 125	06' - 17'	6332N (rear brake)	(*)	6333N (front brake)	(*)
X-MAX 125	18'	9493N (rear brake)	(*)	7861N (front brake)	(*)
X-MAX 250	10' - 16'	6332N (rear brake)	(*)	6333N (front brake)	(*)
X-MAX 300	17' - 18'	9493N (rear brake)	(*)	7861N (front brake)	(*)
X-MAX 400	13' - 18'	7000N (rear brake)	(*)	7001N (front brake)	(*)
XJ6	09' - 16'	8503N	(*)	5462N	(*)
XJ6 DIVERSION	09' - 16'	8503N	(*)	5462N	(*)
XJ6 DIVERSION F	10' - 16'	8503N	(*)	5462N	(*)
XJR1200	94' - 98'	5465N	(*)	5455N	(*)
XJR1300	04' - 16'	5465N	(*)	5462N	(*)
XSR700	16' - 18'	8503N	(*)	5462N	(*)
XSR900	16' - 18'	8503N	(*)	5462N	(*)
XT660R	04' - 16'	5855N	(*)	5854N	(*)
XT660X	04' - 16'	5855N	(*)	5854N	(*)
XT660Z TÉNÉRÉ	08' - 18'	6120N	(*)	5462N	(*)
XT1200Z SUPER TÉNÉRÉ	10' - 18'	5465N	(*)	5462N	(*)
YZF-R125	14' - 18'	6120N	(*)	7582N	(*)
YZF-R1	99' - 01'	8503N	(*)	6609N	(*)
YZF-R1	02' - 03'	8503N	(*)	5455N	(*)
YZF-R1	04' - 08'	8503N	(*)	5464N	(*)
YZF-R1	09' - 14'	8503N	(*)	5768N	(*)
YZF-R1	15' - 18'	8503N	(*)	7860N	(*)
YZF-R1M	17' - 18'	8503N	(*)	7860N	(*)
YZF-R3	15' - 18'	7830N	(*)	7861N	(*)
YZF-R6	99' - 04'	8503N	(*)	5455N	(*)
YZF-R6 Bomba Radial	05'	8503N	(*)	5464N	(*)
YZF-R6	05'	8503N	(*)	5455N	(*)
YZF-R6	06' - 16'	8503N	(*)	5464N	(*)
YZF-R6	17' - 18'	8503N	(*)	7860N	(*)



N
Black

(*) Check price with your distributor.
 (#) With production code WB10J01 from now on.
 (#) BMW R NINE T with production code 0A6, 0A16
 (S) BMW R NINE T with production code 0J01, 0J03

IMPORTANT: Indicate code color after part#. Example: 0973A.



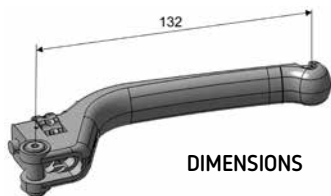

DIMENSIONS



ADJUSTABLE
On distance to grip.

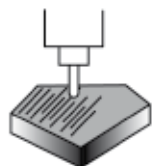

CNC MACHINED
Machined from billet aluminium and anodized in colors.



100gr.



N
Black



NON-FOLDABLE MODEL	REF.	N
UNFOLDABLE BRAKE LEVER	9995N	(*)
ADAPTOR BRAKE LEVER	CONSULT TABLE	(*)
UNFOLDABLE CLUTCH LEVER	9996N	(*)
ADAPTOR CLUTCH LEVER	CONSULT TABLE	(*)

MODEL	YEAR	CLUTCH LEVER ADAPTER	N	BRAKE LEVER ADAPTER	N
HARLEY DAVIDSON					
SPORTSTER 883 IRON	16' - 18'	9645N	(*)	9648N	(*)
HONDA					
CMX 500 REBEL	17' - 18'	9649N	(*)	9646N	(*)
INDIAN					
SCOUT BOBBER	18'	9742N	(*)	9743N	(*)
KAWASAKI					
VULCAN S	15' - 18'	9642N	(*)	9647N	(*)
VULCAN S CAFE	17' - 18'	9642N	(*)	9647N	(*)
TRIUMPH					
BONNEVILLE BOBBER	17' - 18'	9643N	(*)	9650N	(*)
YAMAHA					
SCR 950	17' - 18'	0391N	(*)	1000N	(*)
XV950	14' - 18'	0391N	(*)	1000N	(*)
XV950R	14' - 18'	0391N	(*)	1000N	(*)
XV950 RACER	16'	9644N	(*)	9651N	(*)

(*) Check price with your distributor.



FOLDS OUTWARD

Adaptor designed with spring which allows the lever to swing forward to avoid the lever to twist or break.

DESIGN

Exclusive design: Clutch lever - length of lever for 4 fingers. Brake lever - length for 3 fingers.

REGULATION

The adjustable system allows to adjust the position for rider's needs.

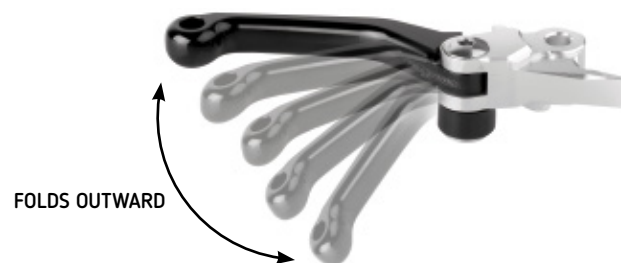

SHORT MODEL 2.0	REF.	N
BRAKE LEVER WITH ADAPTOR (1)	SEE PAGE 232	(*)
CLUTCH LEVER WITH ADAPTOR (2)	SEE PAGE 232	(*)

SPARES	REF.	N
BRAKE LEVER	88888	(*)
CLUTCH LEVER	99999	(*)



N
Black

(*) Check price with your distributor.

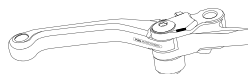

MODEL	YEAR	CLUTCH LEVER + ADAPTOR	N	BRAKE LEVER + ADAPTOR	N
BETA					
RR 2T	13'-17'	20012N	(*)	20018N	(*)
RR/RS 4T	12'-17'	20012N	(*)	20018N	(*)
X-TRAINER	15'-17'	20012N	(*)	20018N	(*)
GAS GAS					
EC 2T	00'-16'	20043N	(*)	20018N	(*)
EC 4T	10'-13'	20043N	(*)	20018N	(*)
EC250 E4	17'	20013N	(*)	20018N	(*)
EC300 E4	17'	20013N	(*)	20018N	(*)
XC250	17'	20013N	(*)	20018N	(*)
XC300	17'	20013N	(*)	20018N	(*)
FSE	03'-09'	20043N	(*)	20018N	(*)
FSR	03'-09'	20043N	(*)	20018N	(*)
HONDA					
CR80R	98'-07'	20001N	(*)	20018N	(*)
CR85R	98'-07'	20001N	(*)	20018N	(*)
CRF150R	07'-18'	20001N	(*)	20018N	(*)
CR125R	92'-03'	20001N	(*)	20018N	(*)
CR125R	04'-07'	20002N	(*)	20018N	(*)
CR250R	92'-03'	20001N	(*)	20018N	(*)
CR250R	04'-07'	20002N	(*)	20018N	(*)
CRF250R	04'-06'	20002N	(*)	20018N	(*)
CRF250R	07'-18'	20002N	(*)	20019N	(*)
CRF450R	02'-03'	20001N	(*)	20018N	(*)
CRF450R	04'-06'	20002N	(*)	20018N	(*)
CRF450R	07'-18'	20002N	(*)	20019N	(*)
CRF450RX	17'-18'	20002N	(*)	20019N	(*)
CRF250X	04'-17'	20002N	(*)	20018N	(*)
CRF450X	05'-17'	20002N	(*)	20018N	(*)
CRF230F	03'-17'	20003N	(*)	20018N	(*)
XR230	05'-12'	20003N	(*)	20015N	(*)
XR230 MOTARD	05'-12'	20003N	(*)	20015N	(*)
XR250	95'-07'	20001N	(*)	20015N	(*)
XR250 MOTARD	95'-07'	20001N	(*)	20015N	(*)
XR400	05'-08'	20001N	(*)	20015N	(*)
XR400 MOTARD	05'-08'	20001N	(*)	20015N	(*)
HUSQVARNA					
TC65	17' - 18'	20044N	(*)	20045N	(*)
TC85	14' - 18'	20044N	(*)	20045N	(*)
TC125	14'-17'	20013N	(*)	20014N	(*)
TC125 - Brembo Brake	18'	20013N	(*)	20014N	(*)

MODEL	YEAR	CLUTCH LEVER + ADAPTOR	N	BRAKE LEVER + ADAPTOR	N
TC125 - Magura Brake	18'	20013N	(*)	20046N	(*)
TC250	14'-17'	20013N	(*)	20014N	(*)
RC250 - Brembo Brake	18'	20013N	(*)	20014N	(*)
RC250 - Magura Brake	18'	20013N	(*)	20046N	(*)
TE125	14'-17'	20013N	(*)	20014N	(*)
TE250	14'-16'	20012N	(*)	20014N	(*)
TE250	17'-18'	20013N	(*)	20014N	(*)
TE300	14'-16'	20012N	(*)	20014N	(*)
TE300	17'-18'	20013N	(*)	20014N	(*)
FC 250	14'-15'	20012N	(*)	20014N	(*)
FC 250	16'-17'	20013N	(*)	20014N	(*)
FC 250 - Brembo Brake	18'	20013N	(*)	20014N	(*)
FC 450 - Magura Brake	18'	20013N	(*)	20046N	(*)
FC 450	14'-15'	20012N	(*)	20014N	(*)
FC 450	16'-17'	20013N	(*)	20014N	(*)
FC 450 - Brembo Brake	18'	20013N	(*)	20014N	(*)
FC 450 - Magura Brake	18'	20013N	(*)	20046N	(*)
FE 250	14'-16'	20012N	(*)	20014N	(*)
FE 250	17'-18'	20013N	(*)	20014N	(*)
FE 501	14'-16'	20012N	(*)	20014N	(*)
FE 501	17'-18'	20013N	(*)	20014N	(*)
FE 501S	14'-16'	20012N	(*)	20014N	(*)
FE 501S	17'-18'	20013N	(*)	20014N	(*)
KAWASAKI					
KX65	00'-18'	20008N	(*)	20020N	(*)
KX85	01'-18'	20008N	(*)	20020N	(*)
KX100	01'-18'	20008N	(*)	20020N	(*)
KX125	00'-05'	20008N	(*)	20020N	(*)
KX125	06'-08'	20009N	(*)	20020N	(*)
KX250	00'-04'	20008N	(*)	20020N	(*)
KX250	05'-08'	20009N	(*)	20020N	(*)
KX250F	04'	20008N	(*)	20020N	(*)
KX250F	05'-12'	20009N	(*)	20020N	(*)
KX250F	13'-18'	20009N	(*)	20021N	(*)
KX450F	06'-12'	20009N	(*)	20020N	(*)
KX450F	13'-18'	20009N	(*)	20021N	(*)
KLX450R	08'-15'	20006N	(*)	20020N	(*)
KTM					
65SX	04'-11'	20007N	(*)	20024N	(*)



N
Black

(*) Check price with your distributor.

IMPORTANT: Indicate code color after part#. Example: 0973A.

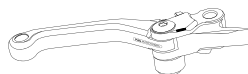

MODEL	YEAR	CLUTCH LEVER + ADAPTOR	N	BRAKE LEVER + ADAPTOR	N
65SX	14'-18'	20044N	(*)	20045N	(*)
65XC	04'-11'	20007N	(*)	20024N	(*)
65XC	14'-18'	20044N	(*)	20045N	(*)
85SX	03'-11'	20007N	(*)	20024N	(*)
85SX	14'-18'	20044N	(*)	20045N	(*)
85XC	03'-11'	20007N	(*)	20024N	(*)
85XC	14'-18'	20044N	(*)	20045N	(*)
125EXC (SIX DAYS)	05'-08'	20007N	(*)	20023N	(*)
125EXC (SIX DAYS)	09'-13'	20013N	(*)	20023N	(*)
125EXC (SIX DAYS)	14'-16'	20013N	(*)	20014N	(*)
125SX	05'-08'	20007N	(*)	20023N	(*)
125SX	09'-13'	20013N	(*)	20023N	(*)
125SX	14'-15'	20013N	(*)	20014N	(*)
125SX	16'-18'	20012N	(*)	20014N	(*)
144SX	07'-08'	20007N	(*)	20023N	(*)
150SX	09'-11'	20013N	(*)	20023N	(*)
150SX	12'-13'	20013N	(*)	20023N	(*)
150SX	14'-15'	20013N	(*)	20014N	(*)
150SX	16'-18'	20012N	(*)	20014N	(*)
150XC	09'-11'	20013N	(*)	20023N	(*)
150XC	12'-13'	20013N	(*)	20023N	(*)
150XC	14'-15'	20013N	(*)	20014N	(*)
150XC	16'-18'	20012N	(*)	20014N	(*)
200XC-W	05'-08'	20007N	(*)	20023N	(*)
200XC-W	09'-13'	20013N	(*)	20023N	(*)
200XC-W	14'-16'	20013N	(*)	20014N	(*)
200EXC	05'-08'	20007N	(*)	20023N	(*)
200EXC	09'-13'	20013N	(*)	20023N	(*)
200EXC	14'-16'	20013N	(*)	20014N	(*)
250EXC (SIX DAYS)	03'-04'	20007N	(*)		(*)
250EXC (SIX DAYS)	05'	20007N	(*)	20023N	(*)
250EXC (SIX DAYS)	06'-13'	20012N	(*)	20023N	(*)
250EXC (SIX DAYS)	14'-18'	20012N	(*)	20014N	(*)
250EXC-F (SIX DAYS)	03'-04'	20007N	(*)		(*)
250EXC-F (SIX DAYS)	05'	20007N	(*)	20023N	(*)
250EXC-F (SIX DAYS)	06'-13'	20012N	(*)	20023N	(*)
250EXC-F (SIX DAYS)	14'-18'	20012N	(*)	20014N	(*)
250SX-F	05'-06'	20007N	(*)	20023N	(*)
250SX-F	07'-13'	20012N	(*)	20023N	(*)
250SX-F	14'-18'	20012N	(*)	20014N	(*)
250SX	03'-04'	20007N	(*)		(*)

MODEL	YEAR	CLUTCH LEVER + ADAPTOR	N	BRAKE LEVER + ADAPTOR	N
250SX	05'	20007N	(*)	20023N	(*)
250SX	06'-13'	20012N	(*)	20023N	(*)
250SX	14'-18'	20012N	(*)	20014N	(*)
250XC	06'-13'	20012N	(*)	20023N	(*)
250XC	14'-18'	20012N	(*)	20014N	(*)
250XC-F	07'-13'	20012N	(*)	20023N	(*)
250XC-F	14'-18'	20012N	(*)	20014N	(*)
250XCF-W	07'-13'	20012N	(*)	20023N	(*)
250XCF-W	14'-18'	20012N	(*)	20014N	(*)
250XC-W	06'-13'	20012N	(*)	20023N	(*)
250XC-W	14'-18'	20012N	(*)	20014N	(*)
300XC-W	06'-13'	20012N	(*)	20023N	(*)
300XC-W	14'-18'	20012N	(*)	20014N	(*)
300EXC (SIX DAYS)	05'	20007N	(*)	20023N	(*)
300EXC (SIX DAYS)	06'-13'	20012N	(*)	20023N	(*)
300EXC (SIX DAYS)	14'-17'	20012N	(*)	20014N	(*)
300XC	06'-13'	20012N	(*)	20023N	(*)
300XC	14'-18'	20012N	(*)	20014N	(*)
350SX-F(SIX DAYS)	11'-13'	20012N	(*)	20023N	(*)
350SX-F(SIX DAYS)	14'-18'	20012N	(*)	20014N	(*)
350XC-F(SIX DAYS)	11'-13'	20012N	(*)	20023N	(*)
350XC-F(SIX DAYS)	14'-18'	20012N	(*)	20014N	(*)
350XCF-W(SIX DAYS)	11'-13'	20012N	(*)	20023N	(*)
350XCF-W(SIX DAYS)	14'-18'	20012N	(*)	20014N	(*)
350EXC-F(SIX DAYS)	11'-13'	20012N	(*)	20023N	(*)
350EXC-F(SIX DAYS)	14'-18'	20012N	(*)	20014N	(*)
400EXC	09'-11'	20012N	(*)	20023N	(*)
400EXC-R	05'-07'	20007N	(*)	20023N	(*)
400XC-W	09'-10'	20012N	(*)	20023N	(*)
450EXC (SIX DAYS)	05'-06'	20007N	(*)	20023N	(*)
450EXC (SIX DAYS)	07'-13'	20012N	(*)	20023N	(*)
450EXC (SIX DAYS)	14'-18'	20012N	(*)	20014N	(*)
450EXC-F (SIX DAYS)	05'-06'	20007N	(*)	20023N	(*)
450EXC-F (SIX DAYS)	07'-13'	20012N	(*)	20023N	(*)
450EXC-F (SIX DAYS)	14'-18'	20012N	(*)	20014N	(*)
450SMR	13'	20012N	(*)	20023N	(*)
450SX	05'-08'	20007N	(*)	20023N	(*)
450SX	09'-12'	20013N	(*)	20023N	(*)
450SX	13'	20012N	(*)	20023N	(*)



N
Black

(*) Check price with your distributor.

IMPORTANT: Indicate code color after part#. Example: 0973A.

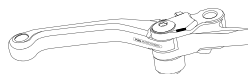

MODEL	YEAR	CLUTCH LEVER + ADAPTOR	N	BRAKE LEVER + ADAPTOR	N
450SX	14'-18'	20012N	(*)	20014N	(*)
450SX-R	05'-08'	20007N	(*)	20023N	(*)
450SX-R	09'-12'	20013N	(*)	20023N	(*)
450SX-R	13'	20012N	(*)	20023N	(*)
450SX-R	14'-18'	20012N	(*)	20014N	(*)
450SX-F	05'-08'	20007N	(*)	20023N	(*)
450SX-F	09'-12'	20013N	(*)	20023N	(*)
450SX-F	13'	20012N	(*)	20023N	(*)
450SX-F	14'-18'	20012N	(*)	20014N	(*)
450XC	06'-07'	20007N	(*)	20023N	(*)
450XC-F	08'	20012N	(*)	20023N	(*)
450XC-F	09'	20007N	(*)	20023N	(*)
450XC-F	13'	20012N	(*)	20023N	(*)
450XC-F	14'-18'	20012N	(*)	20014N	(*)
450XC-W (SIX DAYS)	07'	20007N	(*)	20023N	(*)
450XC-W (SIX DAYS)	08'-13'	20012N	(*)	20023N	(*)
450XC-W (SIX DAYS)	14'-16'	20012N	(*)	20014N	(*)
450XCR-W (SIX DAYS)	07'	20007N	(*)	20023N	(*)
450XCR-W (SIX DAYS)	08'-13'	20012N	(*)	20023N	(*)
450XCR-W (SIX DAYS)	14'-16'	20012N	(*)	20014N	(*)
500XC-W (SIX DAYS)	12'-13'	20012N	(*)	20023N	(*)
500XC-W (SIX DAYS)	14'-18'	20012N	(*)	20014N	(*)
500EXC (SIX DAYS)	12'-13'	20012N	(*)	20023N	(*)
500EXC (SIX DAYS)	14'-18'	20012N	(*)	20014N	(*)
500EXC-F (SIX DAYS)	12'-13'	20012N	(*)	20023N	(*)
500EXC-F (SIX DAYS)	14'-18'	20012N	(*)	20014N	(*)
525SX	05'-07'	20007N	(*)	20023N	(*)
525SX-R	05'-07'	20007N	(*)	20023N	(*)
525XC	05'-07'	20007N	(*)	20023N	(*)
525XC-W	05'-07'	20007N	(*)	20023N	(*)
530EXC-R	08'-11'	20012N	(*)	20023N	(*)
530EXC	08'-11'	20012N	(*)	20023N	(*)
530XCR-W	08'-11'	20012N	(*)	20023N	(*)
530XCR-W	08'-11'	20012N	(*)	20023N	(*)
250 FREERIDE R	14'-17'	20044N	(*)	20045N	(*)
350 FREERIDE	14'-17'	20044N	(*)	20045N	(*)
SUZUKI					
RM85	05'-17'	20005N	(*)	20020N	(*)
RM125	96'-03'	20005N	(*)	20018N	(*)
RM125	04'-08'	20005N	(*)	20020N	(*)
RM250	96'-03'	20005N	(*)	20018N	(*)

MODEL	YEAR	CLUTCH LEVER + ADAPTOR	N	BRAKE LEVER + ADAPTOR	N
RM250	04'-08'	20005N	(*)	20020N	(*)
RMZ250	04'	20008N	(*)	20020N	(*)
RMZ250	05'-06'	20009N	(*)	20020N	(*)
RMZ250	07'-18'	20008N	(*)	20020N	(*)
RMZ450	04'		(*)	20020N	(*)
RMZ450	05'-18'	20008N	(*)	20020N	(*)
DRZ400 S	00'-17'	20004N	(*)	20016N	(*)
DRZ400 SM	00'-17'	20004N	(*)	20016N	(*)
YAMAHA					
YZ80	01'-14'	20005N	(*)	20020N	(*)
YZ80	15'-18'	20010N	(*)	20020N	(*)
YZ85	01'-14'	20005N	(*)	20020N	(*)
YZ85	15'-18'	20010N	(*)	20020N	(*)
YZ125	01'-07'	20009N	(*)	20020N	(*)
YZ125	08'-14'	20009N	(*)	20021N	(*)
YZ125	15'-18'	20010N	(*)	20021N	(*)
YZ250	01'-07'	20009N	(*)	20020N	(*)
YZ250	08'-14'	20009N	(*)	20021N	(*)
YZ250	15'-18'	20010N	(*)	20021N	(*)
YZ250F	01'-06'	20009N	(*)	20020N	(*)
YZ250F	07'-08'	20009N	(*)	20021N	(*)
YZ250F	09'-18'	20010N	(*)	20021N	(*)
YZ426F	01'-07'	20009N	(*)	20020N	(*)
YZ426F	08'	20009N	(*)	20021N	(*)
YZ426F	09'-18'	20010N	(*)	20021N	(*)
YZ450F	01'-07'	20009N	(*)	20020N	(*)
YZ450F	08'	20009N	(*)	20021N	(*)
YZ450F	09'-18'	20010N	(*)	20021N	(*)
YZ125X	17'-18'	20010N	(*)	20021N	(*)
YZ250X	16'-18'	20010N	(*)	20021N	(*)
YZ250FX	15'-18'	20010N	(*)	20021N	(*)
YZ450FX	16'-18'	20010N	(*)	20021N	(*)
WR250F	05'-16'	20006N	(*)	20020N	(*)
WR250F	17'-18'	20006N	(*)	20021N	(*)
WR450F	05'-15'	20006N	(*)	20020N	(*)
WR450F	16'-18'	20006N	(*)	20021N	(*)
WR250R	07'-17'	20005N	(*)	20017N	(*)
WR250X	07'-17'	20005N	(*)	20017N	(*)



N
Black

(*) Check price with your distributor.

IMPORTANT: Indicate code color after part#. Example: 0973A.





R-FIGHTER MODEL	REF.	R O A T N P V
R-FIGHTER FOOTPEGS BY PAIR	9192	(*)
ADAPTERS BY PAIR	SEE PAGE 246	

R-FIGHTER S MODEL	REF.	R O A T N P V
R-FIGHTER S FOOTPEGS BY PAIR	9193	(*)
R-FIGHTER S RUBBERS BY PAIR	9335U	(*)
ADAPTERS BY PAIR	SEE PAGE 246	

DESIGN
Its design offers the best grip.

ADJUSTABLE
On inclination.

PRECISE ADJUSTER
Add marks for proper regulation.

DESIGN
Rubber base to reduce vibrations.

ADJUSTABLE
On inclination.

PRECISE ADJUSTER
Add marks for proper regulation.

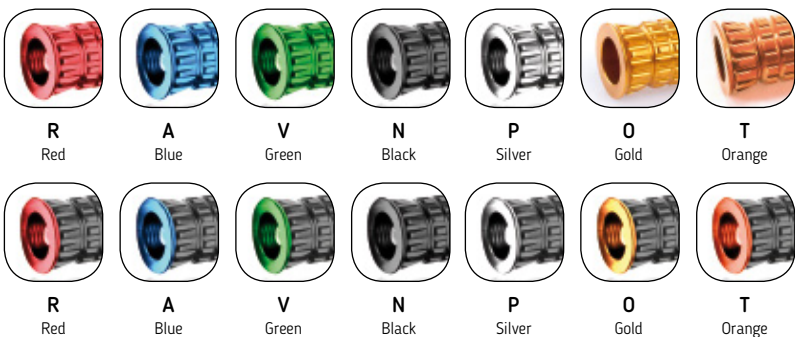

TO MOUNT PUG FOOTPEGS, WE USE PARTS OF OEM FOOTPEGS.
FOOTPEGS FOR RIDERS: all models compatible.
FOOTPEGS FOR PASSENGER: all models compatible except trail and enduro footpegs.

(*) Check price with your distributor.

IMPORTANT: Indicate code color after part#. Example: 0973A.





RACING MODEL	REF.	R O A T N P V
RACING FOOTPEGS BY PAIR	6301	(*)
ADAPTERS BY PAIR	SEE PAGE 246	

SPORT MODEL	REF.	R O A T N P V
SPORT WITH RUBBER FOOTPEGS BY PAIR (1)	7318	(*)
SPORT RUBBER BY PAIR (SPARES)	7320U	(*)
VINTAGE FOOTPEGS BY PAIR (2)	9189	(*)
VINTAGE RUBBERS BY PAIR (SPARES)	9334H	(*)
ADAPTERS BY PAIR	SEE PAGE 246	

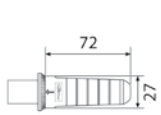

DESIGN
Ergonomic
increasing free
height.



ADJUSTABLE
On inclination.

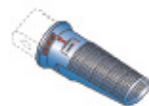

**PRECISE
ADJUSTER**
Add marks
for proper
regulation.

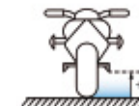
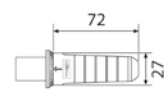

DESIGN
Ergonomic
increasing free
height.



ADJUSTABLE
On inclination.



**PRECISE
ADJUSTER**
Add marks
for proper
regulation.

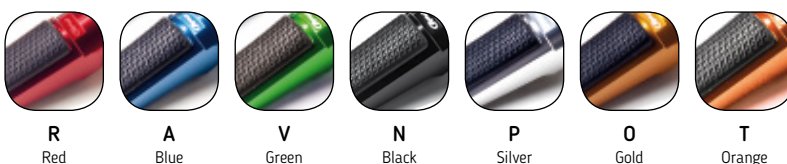
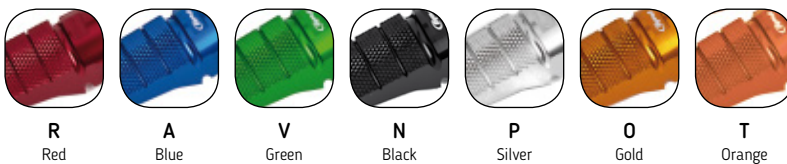

TO MOUNT PUG FOOTPEGS, WE USE PARTS OF OEM FOOTPEGS.
FOOTPEGS FOR RIDERS: all models compatible.
FOOTPEGS FOR PASSENGER: all models compatible except trail and enduro footpegs.

(*) Check price with your distributor.

IMPORTANT: Indicate code color after part#. Example: 0973A.



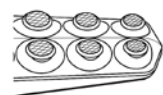
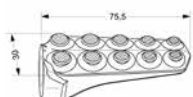

DESIGN
 Ergonomic increasing free height.



ADJUSTABLE
 On inclination.



PRECISE ADJUSTER
 Add marks for proper regulation.



N
 Black

HERITAGE MODEL	REF.	N
HERITAGE FOOTPEGS BY PAIR	9980	(*)
ADAPTERS BY PAIR	SEE PAGE 246	

TO MOUNT PUIG FOOTPEGS, WE USE PARTS OF OEM FOOTPEGS.

FOOTPEGS FOR RIDERS: all models compatible.

FOOTPEGS FOR PASSENGER: all models compatible except trail and enduro footpegs.

(*) Check price with your distributor.

IMPORTANT: Indicate code color after part#. Example: 0973A.





TRAIL MODEL	REF.	R O A T N P V
TRAIL WITH RUBBER FOOTPEGS BY PAIR	7319	(*)
ADAPTERS BY PAIR	SEE PAGE 246	
TRAIL RUBBER BY PAIR (SPARES)	7321U	(*)

ENDURO MODEL	REF.	R O A T N P V
ENDURO WITH RUBBER FOOTPEGS BY PAIR	7587	(*)
ADAPTERS BY PAIR	SEE PAGE 246	
ENDURO RUBBER BY PAIR (SPARES)	8133U	(*)

130gr.

DESIGN
Ergonomic increasing free height.

ADJUSTABLE
On inclination.

PRECISE ADJUSTER
Add marks for proper regulation.

440gr.

WITH OR WITHOUT
The rubbers could be removed.

DESIGN
Ergonomic increasing free height.

ADJUSTABLE
On inclination.

PRECISE ADJUSTER
Add marks for proper regulation.

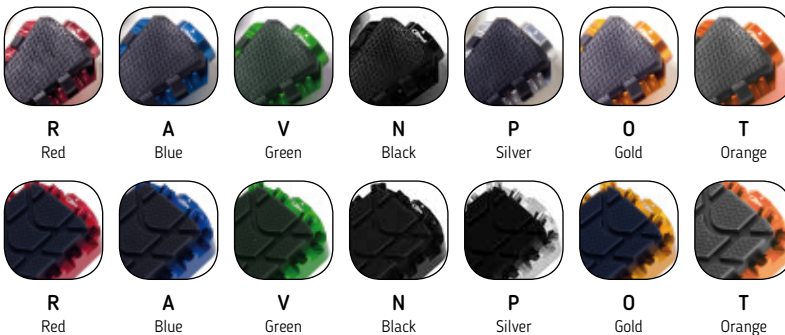

TO MOUNT PUG FOOTPEGS, WE USE PARTS OF OEM FOOTPEGS.
FOOTPEGS FOR RIDERS: all models compatible.
FOOTPEGS FOR PASSENGER: all models compatible except trail and enduro footpegs.

(*) Check price with your distributor.

IMPORTANT: Indicate code color after part#. Example: 0973A.



MODEL	YEAR	ADAPTER BY PAIR RIDER	N	ADAPTER BY PAIR PASSENGER	N
APRILIA					
CAPONORD 1200	13' - 16	7232N	(*)	7233N	(*)
DORSODURO 900	17' - 18'	9641N	(*)	9870N	(*)
RSV4	09' - 12'	6864N	(*)	6865N	(*)
RSV4 FACTORY	13' - 14'	6864N	(*)	6865N	(*)
SHIVER 750	07' - 16'	6338N	(*)	6339N	(*)
SHIVER 900	17' - 18'	6338N	(*)	9870N	(*)
SRV850	12' - 16'			6633N	(*)
TUONO V4R	11' - 14'	6864N	(*)	6865N	(*)
BENELLI					
LEONCINO 500	16' - 18'	9696N	(*)	9697N	(*)
BMW					
C600 SPORT	12' - 14'			6341N	(*)
C600 SPORT	15'			8771N	(*)
C650 SPORT	16' - 18'			8771N	(*)
F650 GS	08' - 12'	7238N	(*)	7239N	(*)
F700 GS	12' - 17'	7238N	(*)	7239N	(*)
F750 GS	18'	7246N	(*)	9784N	(*)
F800 GT	13' - 18'	6672N		6647N	(*)
F800 GS	08' - 17'	7238N	(*)	7239N	(*)
F800 GS ADVENTURE	13' - 18'	7238N	(*)	7239N	(*)
F800 R	09' - 18	6340N	(*)	6341N	(*)
F850 GS	18'	7246N	(*)	9784N	(*)
G310 GS	17' - 18'	9950N	(*)	8770N	(*)
G310 R	16' - 18'	8876N	(*)	8770N	(*)
G650 GS	11' - 16'	7240N	(*)	7241N	(*)
R1200 GS	04' - 12'	7242N	(*)	7243N	(*)
R1200 GS	13' - 16'	7246N	(*)	7249N	(*)
R1200 GS	17' - 18'	7246N	(*)	7249N	(*)
R1200 GS RALLYE	17' - 18'	9471N	(*)	7249N	(*)
R1200 GS EXCLUSIVE	17' - 18'	7246N	(*)	7249N	(*)
R1200 GS ADVENTURE	06' - 13'	7248N	(*)	7245N	(*)
R1200GS ADVENTURE	14' - 18'	7248N	(*)	7249N	(*)
R1250 GS	18'	7246N	(*)	7249N	(*)
R1200 R	10' - 14'			6647N	(*)
R1200 R	15' - 18'	7200N	(*)	6647N	(*)
R1200 RS	15' - 18'	7200N	(*)	6647N	(*)
K1200R	05' - 08'	6340N	(*)	6341N	(*)
K1300 R	09' - 16'	6340N	(*)	6341N	(*)

MODEL	YEAR	ADAPTER BY PAIR RIDER	N	ADAPTER BY PAIR PASSENGER	N
R NINE T	14' - 18'	7200N	(*)	6647N	(*)
R NINE T SCRAMBLER	16' - 18'	8877N	(*)	6647N	(*)
R NINE T PURE	17' - 18'	7200N	(*)	6647N	(*)
R NINE T RACER	17' - 18'	6866N	(*)		
R NINE T URBAN G/S	17' - 18'	8877N	(*)	6647N	(*)
S1000 R	14' - 18'	6866N	(*)	7203N	(*)
S1000 RR	09' - 18'	6866N	(*)	7203N	(*)
S1000 XR	15' - 18'	7246N	(*)	7249N	(*)
DUCATI					
848	08' - 13'	6997N	(*)	6997N	(*)
899 PANIGALE	14' - 15'	6997N	(*)	6997N	(*)
959 PANIGALE	16' - 18'	6997N	(*)	6997N	(*)
1199 PANIGALE	12' - 14'	6997N	(*)	6997N	(*)
1199 SUPERLEGGERA	14'	6997N	(*)	6997N	(*)
1299 PANIGALE/S	15' - 17'	6997N	(*)	6997N	(*)
PANIGALE V4	18'	6997N	(*)		
PANIGALE V4 S	18'	6997N	(*)		
PANIGALE V4 SPECIALE	18'	6997N	(*)		
HYPERMOTARD 821/SP	13' - 15'	6755N	(*)	6755N	(*)
HYPERMOTARD 939/SP	16' - 18'	6755N	(*)	6755N	(*)
HYPERSTRADA	13' - 15'	6755N	(*)	6755N	(*)
HYPERSTRADA 939/SP	16' - 17'	8880N	(*)	8776N	(*)
MONSTER 696	08' - 14'	6342N	(*)	6342N	(*)
MONSTER 796	10' - 14'	6342N	(*)	6342N	(*)
MONSTER 1100	09' - 10'	6342N	(*)	6342N	(*)
MONSTER 1100 S	09' - 10'	6342N	(*)	6342N	(*)
MONSTER 1100 EVO	11' - 13'	6342N	(*)	6342N	(*)
MONSTER 797	17' - 18'	7874N	(*)	7874N	(*)
MONSTER 821	14' - 18'	7206N	(*)	7206N	(*)
MONSTER 1200/S	14' - 16'	7206N	(*)	7206N	(*)
MONSTER 1200/S	17' - 18'	7206N	(*)	7206N	(*)
MONSTER 1200 R	16' - 18'	8777N	(*)	8778N	(*)
MULTISTRADA 950	17' - 18'	9480N	(*)	9480N	(*)
MULTISTRADA 1200/ S	10' - 14'	6755N	(*)	6755N	(*)
MULTISTRADA 1200/S	15' - 17'	6755N	(*)	6755N	(*)
MULTISTRADA 1200 ENDURO/PRO	16' - 18'	8881N	(*)	8779N	(*)
MULTISTRADA 1200 PIKES PEAK	16' - 17'	6755N	(*)	6755N	(*)
MULTISTRADA 1260/S/S DJAIR	18'	9480N	(*)	9480N	(*)
MULTISTRADA 1260 PIKES PEAK	18'	9480N	(*)	9480N	(*)
SCRAMBLER ICON/CLASSIC/FULL THROTTLE	15' - 18'	7874N	(*)	7874N	(*)



N
Black

TO MOUNT PUIG FOOTPEGS, WE USE PARTS OF OEM FOOTPEGS.

(*) Check price with your distributor.

IMPORTANT: Indicate code color after part#. Example: 0973A.

FOOTPEGS ADAPTERS

HI-TECH PARTS

2019
MODELS:
www.puig.tv



MODEL	YEAR	ADAPTER BY PAIR RIDER	N	ADAPTER BY PAIR PASSENGER	N
SCRAMBLER SIXTY2	16' - 18'	7874N	(*)	7874N	(*)
SCRAMBLER URBAN ENDURO	15' - 16'	7874N	(*)	7874N	(*)
SCRAMBLER FLAT TRACK PRO	16'	7874N	(*)	7874N	(*)
SCRAMBLER DESERT SLED	17' - 18'	7206N	(*)	9480N	(*)
SCRAMBLER CAFE RACER	17' - 18'	7874N	(*)	7874N	(*)
SCRAMBLER 1100	18'	7206N	(*)	7874N	(*)
SCRAMBLER 1100 SPORT	18'	7206N	(*)	7874N	(*)
SCRAMBLER 1100 SPECIAL	18'	7206N	(*)	7874N	(*)
STREETFIGHTER 848	12' - 15'	6997N	(*)	6997N	(*)
SUPERSPORT 939/S	17' - 18'	7874N	(*)	7874N	(*)
HARLEY DAVIDSON					
SPORTSTER 883 IRON	09' - 18'	9997N	(*)	9997N	(*)
SPORTSTER 883 SUPERLOW	11' - 18'	9997N	(*)	9997N	(*)
SPORTSTER 883R ROADSTER	02' - 15'	9997N	(*)	9997N	(*)
SPORTSTER 883 LOW	04' - 10'	9997N	(*)	9997N	(*)
SPORTSTER 883 CUSTOM	04' - 10'	9997N	(*)	9997N	(*)
SPORTSTER 1200 IRON	18'	9997N	(*)	9997N	(*)
SPORTSTER 1200 ROADSTER	17' - 18'	9997N	(*)	9997N	(*)
SPORTSTER 1200 NIGHTSTER	08' - 12'	9997N	(*)	9997N	(*)
SPORTSTER 1200 LOW	07' - 09'	9997N	(*)	9997N	(*)
SPORTSTER 1200 CUSTOM	04' - 10'	9997N	(*)	9997N	(*)
SPORTSTER 1200 SUPERLOW	14' - 18'	9997N	(*)	9997N	(*)
SPORTSTER 1200 CB CUSTOM	13' - 17'	9997N	(*)	9997N	(*)
SPORTSTER 1200 CA CUSTOM	13' - 16'	9997N	(*)	9997N	(*)
SPORTSTER FORTY-EIGHT	10' - 18'	9997N	(*)	9997N	(*)
SPORTSTER SEVENTY-TWO	13' - 16'	9997N	(*)	9997N	(*)
HONDA					
CB125R NEO SPORTS CAFE	18'	6347N	(*)	6343N	(*)
CB300R NEO SPORTS CAFE	18'	6347N	(*)	6343N	(*)
CB1000R NEO SPORTS CAFE	18'	6347N	(*)	6343N	(*)
CB500F	13' - 15'	6703N	(*)	6645N	(*)
CB500F	16' - 18'	6703N	(*)	6343N	(*)
CB500X	13' - 18'	6703N	(*)	6645N	(*)
CMX 500 REBEL	17' - 18'	9619N	(*)	6343N	(*)
CB600F HORNET	02' - 06'	6347N	(*)	6676N	(*)
CB600F HORNET	07' - 15'	6347N	(*)	6448N	(*)
CB650F	14' - 18'	6347N	(*)	6343N	(*)
CB1000R	08' - 16'	6347N	(*)	6448N	(*)
CB1100	13' - 14'	6456N	(*)	6357N	(*)

MODEL	YEAR	ADAPTER BY PAIR RIDER	N	ADAPTER BY PAIR PASSENGER	N
CB1100RS	17' - 18'	6346N	(*)	6343N	(*)
CB1100EX	17' - 18'	6346N	(*)	6343N	(*)
CBF600	04' - 14'	6347N	(*)	6644N	(*)
CBF600S	08' - 14'	6347N	(*)	6644N	(*)
CBF1000	06' - 11'	6347N	(*)	6644N	(*)
CBR600F	01' - 13'	6347N	(*)	6448N	(*)
CBR650F	14' - 18'	6347N	(*)	6343N	(*)
CBR250R	11' - 14'	6347N	(*)	6645N	(*)
CBR500R	13' - 15'	6703N	(*)	6645N	(*)
CBR500R	16' - 18'	6703N	(*)	6343N	(*)
CBR600RR	03' - 16'	6347N	(*)	6448N	(*)
CBR900RR FIRE BLADE	00' - 01'	6347N	(*)	6448N	(*)
CBR900RR FIRE BLADE	02' - 03'	6347N	(*)	6448N	(*)
CBR1000RR FIREBLADE	04' - 13'	6347N	(*)	6448N	(*)
CBR1000RR FIREBLADE/SP	14' - 16'	6347N	(*)	6448N	(*)
CBR1000RR FIREBLADE/SP/SP2	17' - 18'	6703N	(*)		
CROSSRUNNER	11' - 14'	6344N	(*)	6345N	(*)
CROSSRUNNER	15' - 18'	6703N	(*)	6343N	(*)
CROSSTOURER	12' - 18'	6703N	(*)	7261N	(*)
INTEGRA 700	12' - 13'			6343N	(*)
INTEGRA 750	14' - 18'			6343N	(*)
NC700S/X	12' - 13'	6346N	(*)	6343N	(*)
NC750S/X	14' - 15'	6346N	(*)	6343N	(*)
NC750S/X	16' - 18'	6703N	(*)	6343N	(*)
MSX125	14' - 18'	6347N	(*)	6345N	(*)
VFR800F	14' - 18'	6703N	(*)	6343N	(*)
VFR1200F	10' - 16'	6346N	(*)	6349N	(*)
VTR1000 SP-1	00' - 02'	6347N	(*)	6448N	(*)
VTR1000 SP-2	02' - 05'	6347N	(*)	6448N	(*)
X-ADV	17' - 18'	9484N	(*)		
INDIAN					
SCOUT BOBBER	18'	9745N	(*)		
KAWASAKI					
ER-6F	06' - 16'	6449N	(*)	6351N	(*)
ER-6N	05' - 16'	6449N	(*)	6351N	(*)
NINJA 250R	08' - 12'	6449N	(*)	6451N	(*)
NINJA 250SL	15' - 16'	6449N	(*)	6451N	(*)
NINJA 300	13' - 17'	6449N	(*)	6451N	(*)
NINJA 400	18'	8887N	(*)	6351N	(*)
NINJA 650	17' - 18'	6449N	(*)	6351N	(*)



N
Black

TO MOUNT PUIG FOOTPEGS, WE USE PARTS OF OEM FOOTPEGS.

(*) Check price with your distributor.

IMPORTANT: Indicate code color after part#. Example: 0973A.

FOOTPEGS ADAPTERS

HI-TECH PARTS

2019
MODELS:
www.puig.tv



MODEL	YEAR	ADAPTER BY PAIR RIDER	N	ADAPTER BY PAIR PASSENGER	N
NINJA H2 SX	18'	6450N	(*)	6351N	(*)
VERSYS-X 300	17' - 18'	6449N	(*)	6451N	(*)
VERSYS 650	10' - 18'	6449N	(*)	6351N	(*)
VERSYS 1000	12' - 18'	6449N	(*)	6351N	(*)
VULCAN S	15' - 18'	9617N	(*)	9618N	(*)
VULCAN S CAFE	17' - 18'	9617N	(*)	9618N	(*)
Z250SL	15' - 16'	6449N	(*)	6451N	(*)
Z125	17' - 18'	6449N	(*)	6451N	(*)
Z300	15' - 17'	6449N	(*)	6451N	(*)
Z650	17' - 18'	6449N	(*)	6351N	(*)
Z750	04' - 12'	6450N	(*)	6351N	(*)
Z750R	11' - 12'	6677N	(*)	6351N	(*)
Z800	13' - 16'	6677N	(*)	6351N	(*)
Z800E	13' - 16'	6677N	(*)	6351N	(*)
Z900	17' - 18'	6449N	(*)	6351N	(*)
Z900RS	18'	6449N	(*)	6351N	(*)
Z1000	03' - 09'	6450N	(*)	6351N	(*)
Z1000	10' - 13'	6677N	(*)	6351N	(*)
Z1000	14' - 18'	6677N	(*)	6351N	(*)
Z1000R	17' - 18'	6677N	(*)	6351N	(*)
Z1000SX	11' - 18'	6450N	(*)	6351N	(*)
ZX-6R	03' - 16'	6677N	(*)	6351N	(*)
ZX-6R 636	13' - 16'	6677N	(*)	6351N	(*)
ZX-10R	04' - 10'	6677N	(*)	6351N	(*)
ZX-10R	11' - 15'	6678N	(*)	6351N	(*)
ZX-10R	16' - 18'	8887N	(*)	6351N	(*)
ZX-10RR	17' - 18'	8887N	(*)	6351N	(*)
ZX-10R SE	18'	8887N	(*)	6351N	(*)
ZZR1400	12' - 18'	6450N	(*)	6351N	(*)
KTM					
125 DUKE	11' - 16'	6338N	(*)	9520N	(*)
125 DUKE	17' - 18'	6338N	(*)	9520N	(*)
200 DUKE	12' - 15'	6338N	(*)	6770N	(*)
390 DUKE	13' - 16'	6338N	(*)	6770N	(*)
390 DUKE	17' - 18'	6338N	(*)	9520N	(*)
690 DUKE	16' - 18'	7210N	(*)	7211N	(*)
690 DUKE R	16' - 17'	7210N	(*)	7211N	(*)
790 DUKE	18'	7210N	(*)	7211N	(*)
990 SUPERMOTO	08' - 13'	7268N	(*)	7269N	(*)

MODEL	YEAR	ADAPTER BY PAIR RIDER	N	ADAPTER BY PAIR PASSENGER	N
1050 ADVENTURE	15' - 16'	7268N	(*)	7269N	(*)
1090 ADVENTURE /R	17' - 18'	7268N	(*)	7269N	(*)
1190 ADVENTURE/R	13' - 16'	7268N	(*)	7269N	(*)
1290 SUPER ADVENTURE	15' - 16'	7268N	(*)	7269N	(*)
1290 SUPER ADVENTURE R	17' - 18'	7268N	(*)	7269N	(*)
1290 SUPER ADVENTURE S	17' - 18'	7268N	(*)	7269N	(*)
1290 SUPER ADVENTURE T	17' - 18'	7268N	(*)	7269N	(*)
1290 SUPERDUKE R	14' - 16'	7208N	(*)	7209N	(*)
1290 SUPERDUKE R	17' - 18'	7208N	(*)	7209N	(*)
1290 SUPERDUKE GT	16' - 18'	7208N	(*)	7209N	(*)
RC125/RC390	14' - 18'	7210N	(*)	7211N	(*)
KYMCO					
AK 550	17' - 18'			9541N	(*)
MV AGUSTA					
BRUTALE 675	12' - 18'	6867N	(*)	6868N	(*)
BRUTALE 800/RR	13' - 18'	6867N	(*)	6868N	(*)
F3 675	12' - 18'	6867N	(*)	6868N	(*)
F4 1000	10' - 18'	6867N	(*)	6868N	(*)
TURISMO VELOCE 800/LUSSO	14' - 18'	9235N	(*)	9235N	(*)
SUZUKI					
B-KING	08' - 11'	6453N	(*)	6353N	(*)
DL250 V-STROM	17' - 18'	6453N	(*)	9963N	(*)
DL650 V-STROM	04' - 18'	6791N	(*)	7271N	(*)
DL650XT V-STROM	15' - 18'	6791N	(*)	7271N	(*)
DL1000 V-STROM	14' - 18'	6791N	(*)	7275N	(*)
DL1000XT V-STROM	17' - 18'	6791N	(*)	7275N	(*)
GSR600	06' - 11'	6453N	(*)	6353N	(*)
GSR750	11' - 16'	6453N	(*)	6353N	(*)
GSX-R125	17' - 18'	6453N	(*)	9963N	(*)
GSX-R250	17' - 18'	6791N	(*)	9657N	(*)
GSX-R600	01' - 05'	6449N	(*)	6679N	(*)
GSX-R600	06' - 16'	6453N	(*)	6353N	(*)
GSX-R750	01' - 05'	6449N	(*)	6679N	(*)
GSX-R750	06' - 16'	6453N	(*)	6353N	(*)
GSX-R1000	01' - 04'	6453N	(*)	6679N	(*)
GSX-R1000	05' - 16'	6453N	(*)	6353N	(*)
GSX-R1000/R	17' - 18'	6453N	(*)	9495N	(*)
GSX-S125	17' - 18'	6453N	(*)	9963N	(*)
GSX-S750	17' - 18'	6453N	(*)	9495N	(*)
GSX-S1000	15' - 18'	6453N	(*)	7923N	(*)



N
Black

TO MOUNT PUIG FOOTPEGS, WE USE PARTS OF OEM FOOTPEGS.

(*) Check price with your distributor.

IMPORTANT: Indicate code color after part#. Example: 0973A.

FOOTPEGS ADAPTERS

HI-TECH PARTS

2019
MODELS:
www.puig.tv



MODEL	YEAR	ADAPTER BY PAIR RIDER	N	ADAPTER BY PAIR PASSENGER	N
GSX-S1000F	15' - 18'	6453N	(*)	7923N	(*)
INAZUMA	13' - 17'	6791N	(*)	6353N	(*)
SFV650 GLADIUS	09' - 15'	6453N	(*)	6353N	(*)
SV1000S	03' - 05'	6449N	(*)	6679N	(*)
SV650S	03' - 08'	6449N	(*)	6679N	(*)
SV650	16' - 18'	6453N	(*)	6353N	(*)
SV650X	18'	6453N	(*)	6353N	(*)
TRIUMPH					
BONNEVILLE T100/T120	16' - 18'	6797N	(*)	6798N	(*)
BONNEVILLE BOBBER	17' - 18'	6797N	(*)		
DAYTONA 675	09' - 17'	6797N	(*)	6798N	(*)
DAYTONA 675 R	11' - 17'	6797N	(*)	6798N	(*)
SPEED TRIPLE	11' - 15'	6797N	(*)	6798N	(*)
SPEED TRIPLE/R	16' - 18'	6797N	(*)	6798N	(*)
STREET CUP	17' - 18'	6797N	(*)	6798N	(*)
STREET SCRAMBLER	17' - 18'	7276N	(*)	6798N	(*)
STREET TRIPLE	08' - 18'	6797N	(*)	6798N	(*)
STREET TRIPLE R	09' - 18'	6797N	(*)	6798N	(*)
STREET TRIPLE S/R	17' - 18'	6797N	(*)	6798N	(*)
STREET TWIN	16' - 18'	6797N	(*)	6798N	(*)
THRUXTON 1200/R	16' - 18'	6797N	(*)	6798N	(*)
TIGER 800	11' - 14'	7276N	(*)	7277N	(*)
TIGER 800 XC	11' - 14'	7276N	(*)	7277N	(*)
TIGER 800 XC/XC/XCA	15' - 18'	7276N	(*)	7277N	(*)
TIGER 800 XR/XRX/XRT	15' - 18'	7276N	(*)	7277N	(*)
TIGER SPORT	13' - 18'	6797N	(*)	7576N	(*)
TIGER EXPLORER	12' - 15'	8796N	(*)	8798N	(*)
TIGER EXPLORER XC	13' - 15'	8796N	(*)	8798N	(*)
TIGER EXPLORER XC/XR/XRX/XRT/XC/XCA	16' - 18'	8796N	(*)	8798N	(*)
YAMAHA					
FJR1300A/AS	13' - 18'	6456N	(*)	6359N	(*)
FZ1	06' - 15'	6455N	(*)	6357N	(*)
FZ1 FAZER	06' - 15'	6455N	(*)	6357N	(*)
FZ6	04' - 08'	6456N	(*)	6359N	(*)
FZ6 FAZER	07' - 08'	6456N	(*)	6359N	(*)
FZ6 FAZER S2	07' - 10'	6456N	(*)	6359N	(*)
FZ8	10' - 12'	6455N	(*)	8183N	(*)
FZ8	13' - 16'	6455N	(*)	8183N	(*)
FZ8 FAZER	10' - 12'	6455N	(*)	8183N	(*)

MODEL	YEAR	ADAPTER BY PAIR RIDER	N	ADAPTER BY PAIR PASSENGER	N
FAZER8	13' - 16'	6455N	(*)	8183N	(*)
FZS1000 FAZER	01' - 05'	6455N	(*)	6359N	(*)
MT-125	14' - 18'	6454N	(*)	6357N	(*)
MT-03	16' - 18'	6454N	(*)	6357N	(*)
MT-07	14' - 18'	6456N	(*)	6357N	(*)
MT-07 TRACER	16' - 18'	6456N	(*)	6359N	(*)
MT-09	13' - 16'	6456N	(*)	6357N	(*)
MT-09	17' - 18'	6456N	(*)	6357N	(*)
MT-09 SP	18'	6456N	(*)	6357N	(*)
MT-09 TRACER	15' - 18'	6456N	(*)	6357N	(*)
MT-09 TRACER GT	18'	6456N	(*)	6357N	(*)
MT-10	16' - 18'	6454N	(*)	6357N	(*)
MT-10 SP	17' - 18'	6454N	(*)	6357N	(*)
SCR950	17' - 18'	6456N	(*)		
T-MAX 500	08' - 11'			6355N	(*)
T-MAX 530	12' - 14'			6355N	(*)
T-MAX 530	15' - 16'			6355N	(*)
T-MAX 530/DX/SX	17' - 18'			6357N	(*)
XV950	14'-18'	9615N	(*)	9616N	(*)
XV950R	14'-18'	9615N	(*)	9616N	(*)
XV950 RACER	16'	9615N	(*)	9616N	(*)
X-MAX 125	10' - 18'			6357N	(*)
X-MAX 250	10' - 16'			6357N	(*)
X-MAX 300	17' - 18'			6357N	(*)
X-MAX 400	13' - 18'			6357N	(*)
XSR700	16' - 18'	6456N	(*)	6357N	(*)
XSR900	16' - 18'	6456N	(*)	6357N	(*)
XJ6	09' - 16'	6456N	(*)	6355N	(*)
XJ6 DIVERSION	09' - 16'	6456N	(*)	6355N	(*)
XJ6 DIVERSION F	10' - 16'	6456N	(*)	6355N	(*)
XT660Z TÉNÉRE	08' - 16'	7282N	(*)	6359N	(*)
XT1200Z SUPER TÉNÉRE	10' - 18'	6455N	(*)		
YZF-R125	08' - 18'	6454N	(*)	6357N	(*)
YZF-R1	02' - 18'	6457N	(*)	6458N	(*)
YZF-R1M	17' - 18'	6457N	(*)	6458N	(*)
YZF-R3	15' - 18'	6454N	(*)	6357N	(*)
YZF-R6	03' - 18'	6457N	(*)	6458N	(*)



N
Black

TO MOUNT PUIG FOOTPEGS, WE USE PARTS OF OEM FOOTPEGS.

(*) Check price with your distributor.

IMPORTANT: Indicate code color after part#. Example: 0973A.





The black base and color caps are sold separately.

THRUSTER MODEL	REF.	R	O	A	T	N
BAR ENDS BY PAIR THRUSTER MODEL	SEE PAGE 460					
SET OF UNIVERSAL BLACK SECTION FOR HANDLEBARS DIAMETERS BETWEEN 13-18 mm.	9411					(*)
CAP'S BAR ENDS THRUSTER	9420					(*)
BAR ENDS BY PAIR FOR PUIG HANDLEBAR WITH INTERIOR THREAD	9594					(*)



SPARES	REF.	N
WELLNUT M10 BY PAIR	6815N	(*)
WELLNUT M15 BY PAIR	6816N	(*)
WELLNUT M17 BY PAIR	6817N	(*)

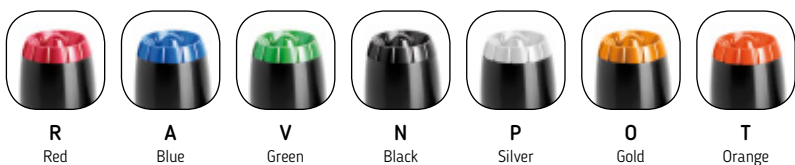

(*) Check price with your distributor.

IMPORTANT: Indicate code color after part#. Example: 0973A.



PUIG HI-TECH PARTS

PUIG
HI-TECH
PARTS



LONG MODEL	REF.	
BAR ENDS BY PAIR LONG MODEL	SEE PAGE 460	
SET OF UNIVERSAL BLACK SECTION FOR HANDLEBARS DIAMETERS BETWEEN 13-18 mm.	5777	(*)
BAR ENDS BY PAIR FOR PUIG HANDLEBAR WITH INTERIOR THREAD	7425	(*)



SHORT MODEL	REF.	
BAR ENDS BY PAIR SHORT MODEL	SEE PAGE 460	
SET OF UNIVERSAL BLACK SECTION FOR HANDLEBARS DIAMETERS BETWEEN 13-18 mm.	6203	(*)
BAR ENDS BY PAIR FOR PUIG HANDLEBAR WITH INTERIOR THREAD	7424	(*)



SPARES	REF.	PRICE
WELLNUT M10 BY PAIR	6815N	(*)
WELLNUT M15 BY PAIR	6816N	(*)
WELLNUT M17 BY PAIR	6817N	(*)

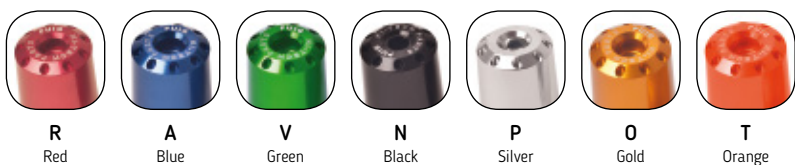

(*) Check price with your distributor.

IMPORTANT: Indicate code color after part#. Example: 0973A.





SHORT WITH RING MODEL	REF.	N
BAR ENDS BY PAIR SHORT WITH RING MODELS	SEE PAGE 460	
SET OF UNIVERSAL BLACK SECTION FOR HANDLEBARS DIAMETERS BETWEEN 13-18 mm.	8498	(*)
BAR ENDS BY PAIR FOR PUIG HANDLEBAR WITH INTERIOR THREAD	8334	(*)
SPARES	REF.	R O A N P V T
RINGS BY PAIR	9170	(*)



The set includes 12 rings (2 each color): blue, orange, black, gold, silver, and red.

Green rings only for Kawasaki and Universal models.



RACE MODEL	REF.	R O A T N P V
SET OF UNIVERSAL BLACK SECTION FOR HANDLEBARS DIAMETERS BETWEEN 13-18 mm.	6222	(*)



SPARES	REF.	PRICE
WELLNUT M10 BY PAIR	6815N	(*)
WELLNUT M15 BY PAIR	6816N	(*)
WELLNUT M17 BY PAIR	6817N	(*)

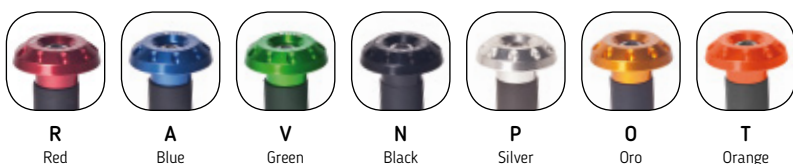

(*) Check price with your distributor.

IMPORTANT: Indicate code color after part#. Example: 0973A.



// CONICAL HANDLEBAR

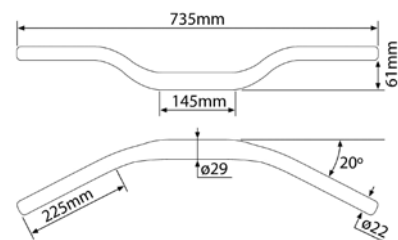
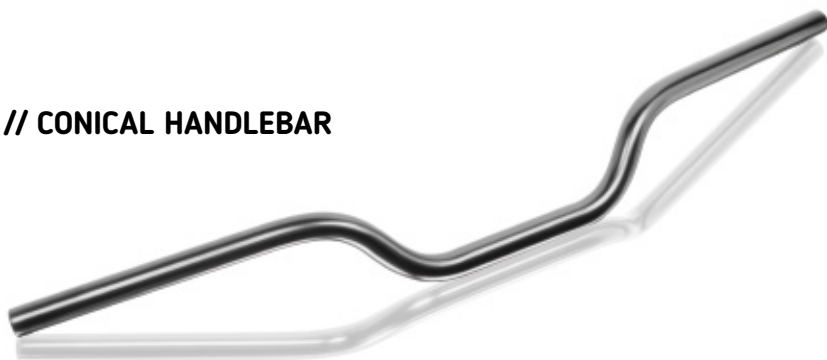

Ø MM.	H (MM)	REF.	R	O	A	N	P
22/29	20	7492				(*)	
22/29	40	7493				(*)	
22/29	61	6461				(*)	

// CYLINDRICAL HANDLEBAR

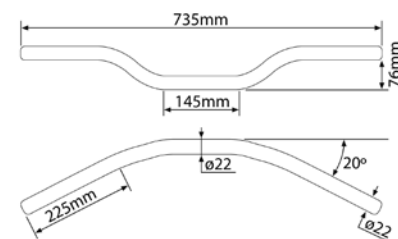
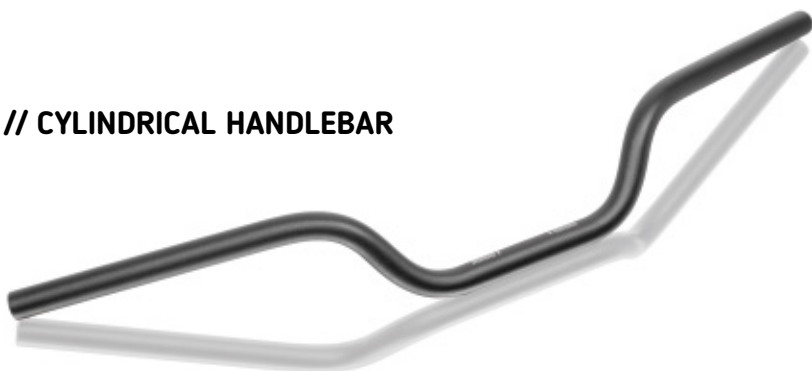

Ø MM.	H (MM)	REF.	R	O	A	N	P
22	76	6242				(*)	
22	46	7494				(*)	

// UNIVERSAL ADAPTOR FOR CONICAL HANDLEBAR

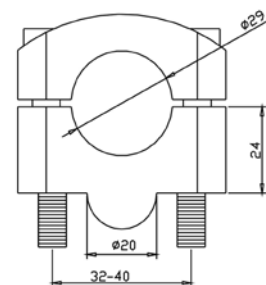

Ø MM.	H (MM)	REF.	N
29	24	6632	(*)

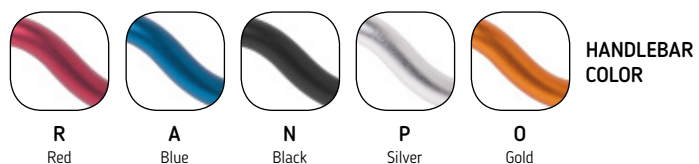

Handlebars suitable for our bar ends and bar ends rear mirrors.

(*) Check price with your distributor.

IMPORTANT: Indicate code color after part#. Example: 0973A.

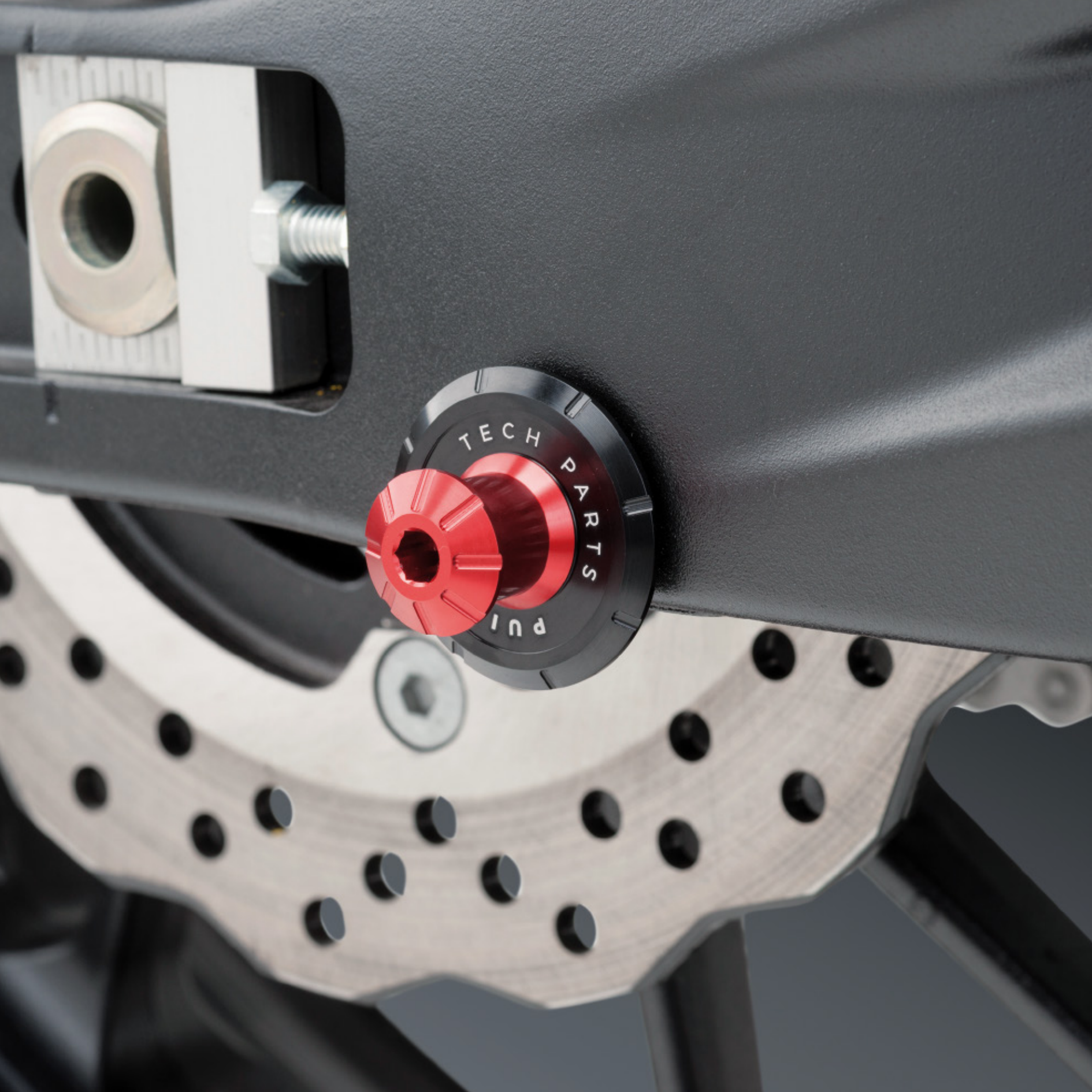

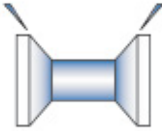

FIXATION

Fitting guide for stand support to lift up motorcycles quick and easy.

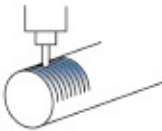

MATERIAL

Manufactured through billet aluminium and CNC machined to increase robustness.

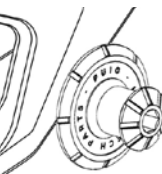

PROTECTION

The swing arm gets protected with the nylon washer added.

DESIGN

Spool and thread machined together to ease the assembly into the bike.

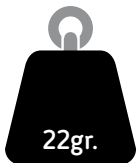

WEIGHT

SPOOL SLIDER
22 grams

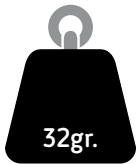

WEIGHT

SPOOL
32 grams

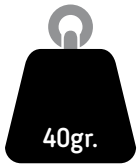

WEIGHT

SPOOL PRO
40 grams

// SPOOL PRO



// SPOOL SLIDER



// SPOOL





75R - 000450



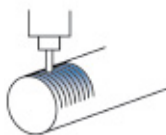

MATERIAL
Manufactured through billet aluminium.

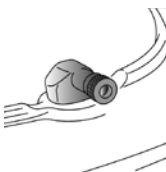

DESIGN
Developed to ease the inflation process.



WEIGHT
8 grams

DIMENSIONS

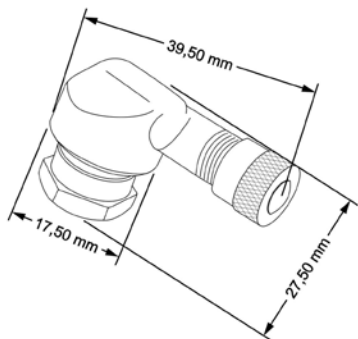

MODEL	Ø THREAD	REF.	A G N P R V T
UNIVERSAL BY PAIR	11 mm.	5591	(*)
UNIVERSAL BY PAIR	8,3 mm.	8100	(*)



A Blue G Yellow N Black P Silver R Red V Green T Orange

(*) Check price with your distributor.

IMPORTANT: Indicate code color after part#. Example: 0973A.





FIXATION

Secure with allen wrench to prevent theft.

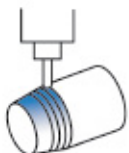

MATERIAL

Manufactured from billet aluminium.



SAFETY

Security system for track.
Wire is not supplied.

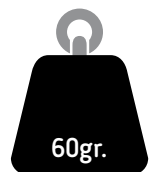

WEIGHT

60 grams



TIGHTEN AND LOOSEN WITH
10 mm. SOCKET WRENCH.





LOCKING
Track homologated closing system.

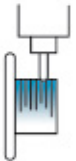

MATERIAL
Manufactured from billet aluminium.

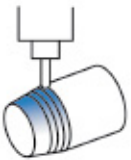

DETAIL
Rubber section for a perfect closure.



DESIGN
Stylish preserving quality and safety.



WEIGHT
195 grams.



WRENCH INCLUDED

RACE FUEL CAPS

HI-TECH PARTS

2019
MODELS:
www.puig.tv

MODEL	YEAR	REF.	D
APRILIA			
CAPONORD 1200	13' - 16'	4791	(*)
CAPONORD 1200 RALLY	15' - 16'	4791	(*)
DORSODURO 750	13' - 16'	4791	(*)
DORSODURO 900	17' - 18'	4791	(*)
DORSODURO 1200	13' - 16'	4791	(*)
MANA 850	13' - 16'	4791	(*)
MANA GT 850	13' - 16'	4791	(*)
RS4 50/RS4 125	13' - 17'	4791	(*)
RSV4 FACTORY	13' - 14'	4791	(*)
RSV4 R	13' - 14'	4791	(*)
RSV4 RF/RR	15' - 17'	4791	(*)
SHIVER 750	13' - 16'	4791	(*)
SHIVER 750 GT	13' - 16'	4791	(*)
SHIVER 900	17' - 18'	4791	(*)
TUONO 125	17' - 18'	4791	(*)
TUONO V4R	13' - 14'	4791	(*)
TUONO V4 RR/FACTORY	15' - 17'	4791	(*)
BMW			
R NINE T	14' - 18'	9330	(*)
F800 GS ADVENTURE	13' - 18'	9330	(*)
F800R	09' - 14'	9330	(*)
R1200 GS	10' - 12'	9330	(*)
R1200 R	06' - 14'	9330	(*)
S1000 R	14' - 18'	9330	(*)
S1000 RR	09' - 18'	9330	(*)
DUCATI			
MONSTER 797	17' - 18'	4788	(*)
848	08' - 10'	4788	(*)
916S/996/998/748		4788	(*)
1098/S/R	07' - 09'	4788	(*)
1198/S/R	09' - 11'	4788	(*)
899 PANIGALE	14' - 15'	9331	(*)
1299 PANIGALE/S	15' - 17'	9331	(*)
1199 PANIGALE	12' - 14'	9331	(*)
PANIGALE V4	18'	4791	(*)
PANIGALE V4S	18'	4791	(*)
PANIGALE V4 SPECIALE	18'	4791	(*)

MODEL	YEAR	REF.	D
DIAVEL	11' - 18'	9331	(*)
MONSTER 821	18'	4788	(*)
STREETFIGHTER 848	12' - 16'	9331	(*)
STREETFIGHTER 1100	09' - 12'	9331	(*)
STREETFIGHTER 1100 S	09' - 13'	9331	(*)
HONDA			
CB125R NEO SPORTS CAFE	18'	7220	(*)
CB1000R NEO SPORTS CAFE	18'	7220	(*)
CB650F	17' - 18'	7220	(*)
CBR650F	17' - 18'	7220	(*)
CB600F HORNET	03' - 16'	4789	(*)
CB1000R	08' - 16'	4789	(*)
CBF600S	04' - 14'	4789	(*)
CBF1000	06' - 11'	4789	(*)
CBR600F	99' - 13'	4789	(*)
CBR600RR	03' - 16'	4789	(*)
CBR900RR	00' - 03'	4789	(*)
CBR1000RR	04' - 13'	4789	(*)
CBR1000RR	14' - 16'	7220	(*)
CBR1000RR FIREBLADE/SP/SP2	17'	7220	(*)
NC700X/S	12' - 13'	4789	(*)
NC750X/S	14' - 18'	4789	(*)
VFR800	02' - 13'	4789	(*)
VTR1000F FIRE STORM	97' - 07'	4789	(*)
VTR1000 SP-1	00' - 02'	4789	(*)
VTR1000 SP-2	02' - 05'	4789	(*)
KAWASAKI			
NINJA 400	18'	9449	(*)
ER-6F/N	09' - 16'	4787	(*)
GTR 1400	07' - 14'	4787	(*)
VERSYS 650	15' - 18'	4787	(*)
VERSYS 1000	12' - 18'	4787	(*)
Z650	17' - 18'	9449	(*)
Z750	07' - 12'	4787	(*)
Z750R	11' - 12'	4787	(*)
Z800	13' - 16'	4787	(*)
Z900	17' - 18'	9449	(*)
Z1000	10' - 13'	4787	(*)



D

Anodized

(*) Check price with your distributor.

IMPORTANT: Indicate code color after part#. Example: 0973A.

MODEL	YEAR	REF.	D
Z1000	14' - 18'	4787	(*)
Z1000SX	11' - 16'	4787	(*)
ZX-6R	09' - 16'	4787	(*)
ZX-6R 636	13' - 16'	4787	(*)
ZX-10R	08' - 15'	4787	(*)
ZX-10R	16' - 17'	4787	(*)
ZX-10R	16' - 17'	4787	(*)
ZZR1400	08' - 10'	4787	(*)
SUZUKI			
DL1000 V-STROM	13' - 18'	4790	(*)
GSF650 BANDIT	05' - 08'	4790	(*)
GSF650S BANDIT	05' - 08'	4790	(*)
GSF1200S BANDIT	06'	4790	(*)
GSF1250 BANDIT	07' - 13'	4790	(*)
GSF1250S BANDIT	07' - 13'	4790	(*)
GSR600	06' - 11'	4790	(*)
GSR750	11' - 16'	4790	(*)
GSX650F	08' - 17'	4790	(*)
GSX1250F	10' - 17'	4790	(*)
GSX-R600	98' - 17'	4790	(*)
GSX-R750	96' - 17'	4790	(*)
GSX-S125	17' - 18'	4790	(*)
GSX-S750	17' - 18'	4790	(*)
GSX-R125	17' - 18'	4790	(*)
GSX-R250	17' - 18'	4790	(*)
GSX-R1000	03' - 14'	4790	(*)
GSX-R1000	15' - 16'	4790	(*)
GSX-S1000	15' - 18'	8209	(*)
GSX-S1000F	15' - 18'	8209	(*)
GSX-R1300 HAYABUSA	08' - 17'	4790	(*)
SFV650 GLADIUS	09' - 15'	4790	(*)
SV650	05' - 08'	4790	(*)
SV650/S	99' - 08'	4790	(*)
SV650X	18'	4790	(*)
SV1000/S	03' - 05'	4790	(*)
TRIUMPH			
DAYTONA 675	06' - 16'	4791	(*)
DAYTONA 675 R	11' - 16'	4791	(*)

MODEL	YEAR	REF.	D
SPEED TRIPLE	05' - 15'	4791	(*)
SPEED TRIPLE R	12' - 18'	4791	(*)
STREET TRIPLE	07' - 18'	4791	(*)
STREET TRIPLE R	08' - 18'	4791	(*)
TIGER 800	11' - 14'	4791	(*)
TIGER 800 XC	11' - 14'	4791	(*)
TIGER 800 XC/XC/XCA	15' - 18'	4791	(*)
TIGER 800 XR/XRX/XRT	15' - 18'	4791	(*)
TIGER 1050	07' - 13'	4791	(*)
TIGER EXPLORER	12' - 15'	4791	(*)
TIGER EXPLORER XC	13' - 15'	4791	(*)
TIGER EXPLORER XC/XR/XRX/XRT/ XCX/XCA	16' - 18'	4791	(*)
YAMAHA			
FJR1300	01' - 05'	4788	(*)
FJR1300AS/A	06' - 12'	4788	(*)
FZ1/FAZER	06' - 15'	4788	(*)
FZ6	04' - 08'	4788	(*)
FZ6 FAZER	07' - 08'	4788	(*)
FZ8	10' - 16'	4788	(*)
FZ8 FAZER	10' - 12'	4788	(*)
FAZER8	13' - 16'	4788	(*)
MT-03	06' - 14'	4788	(*)
MT-07	14' - 18'	4788	(*)
MT-07 TRACER	16' - 18'	4788	(*)
MT-09	13' - 18'	4788	(*)
MT-09 SP	18'	4788	(*)
MT-09 TRACER	15' - 17'	4788	(*)
MT-10	16' - 18'	4788	(*)
XJ6/DIVERSION	09' - 16'	4788	(*)
XJ6 DIVERSION F	10' - 16'	4788	(*)
XJR1300	06' - 13'	4788	(*)
XSR700	16' - 18'	4788	(*)
XSR900	16' - 18'	4788	(*)
YZF-R1	00' - 14'	4788	(*)
YZF-R1	15' - 18'	8211	(*)
YZF-R6	03' - 18'	4788	(*)



D

Anodized

(*) Check price with your distributor.

IMPORTANT: Indicate code color after part#. Example: 0973A.



MODEL	YEAR	Nº SCREWS	REF.	N
BMW				
S1000 R	14' - 17'	WITHOUT SCREWS	6741N	(*)
S1000 RR	09' - 17'	WITHOUT SCREWS	6741N	(*)
DUCATI				
748/916/996/998		5	5150N	(*)
900SS/1000SS/1000DS		5	5150N	(*)
848	08' - 10'	5	5149N	(*)
1098/1098R/1098S	07' - 08'	5	5150N	(*)
1198/1198R/1198S	09' - 11'	5	5149N	(*)
MONSTER 620	02' - 06'	5	5149N	(*)
MONSTER 695	06' - 07'	5	5149N	(*)
MONSTER 821	14' - 17'	5	5149N	(*)
MONSTER 1200/S	14' - 17'	5	5149N	(*)
MONSTER S2R	05' - 07'	5	5149N	(*)
MONSTER S4R	04' - 06'	5	5149N	(*)
MONSTER S4RS	06' - 08'	5	5149N	(*)
MONSTER 797	17' - 18'	5	5149N	(*)
SUPERSPORT 939/S	17' - 18'	5	5149N	(*)
ST3	04' - 07'	5	5150N	(*)
1199 PANIGALE	12' - 14'	WITHOUT SCREWS	9035N	(*)
1299 PANIGALE/S	15' - 17'	WITHOUT SCREWS	9035N	(*)
959 PANIGALE	16' - 17'	WITHOUT SCREWS	9035N	(*)
HONDA				
CBR600F	91' - 07'	7	4614N	(*)
CBR500RR	16' - 18'	5	9036N	(*)
CBR600RR	03' - 13'	7	4614N	(*)
CBR900RR FIRE BLADE	92' - 03'	7	4614N	(*)
CBR1000RR FIRE BLADE	04' - 14'	7	4614N	(*)
CBR1000RR FIRE BLADE	15' - 18'	5	9036N	(*)
CBR1100XX BLACKBIRD	97' - 07'	7	4614N	(*)
NT650 REVERE	88' - 98'	7	4614N	(*)
VFR800F	98' - 01'	7	4614N	(*)
VFR800F	15' - 16'	5	9036N	(*)
VFR800	02' - 13'	7	4614N	(*)
VFR1200F	10' - 16'	7	4614N	(*)
VTR1000F FIRE STORM	97' - 07'	7	4614N	(*)
VTR1000 SP-1	00' - 02'	7	4614N	(*)
VTR1000 SP-2	02' - 05'	7	4614N	(*)



N
Black

Made in light aluminium.

(*) Check price with your distributor.

IMPORTANT: Indicate code color after part#. Example: 0973A.

MODEL	YEAR	Nº SCREWS	REF.	N
KAWASAKI				
ER-6F	06' - 16'	5	4613N	(*)
ER-6N	05' - 16'	5	4613N	(*)
NINJA 250R	08' - 12'	6	6742N	(*)
Z250SL	15' - 17'	6	6742N	(*)
NINJA 300	13' - 15'	6	6742N	(*)
Z750	07' - 12'	5	4613N	(*)
Z750R	11' - 12'	5	4613N	(*)
Z800	13' - 16'	5	4613N	(*)
Z1000	03' - 13'	5	4613N	(*)
Z1000	14' - 18'	5	9700N	(*)
Z1000SX	17' - 18'	5	4613N	(*)
ZX-6R	00' - 16'	5	4613N	(*)
ZX-6R 636	13' - 16'	5	4613N	(*)
ZX-10R	04' - 18'	5	4613N	(*)
GT1400	07' - 16'	5	4613N	(*)
ZZR1400	06' - 16'	5	4613N	(*)
KTM				
1290 SUPERDUKE R	14' - 16'	6	9037N	(*)
MV AGUSTA				
F4 1000	10' - 09'	5	5150N	(*)
F4 750	99' - 04'	5	5150N	(*)
BRUTALE	05' - 09'	5	5150N	(*)
BRUTALE 675	12' - 16'	6	9038N	(*)
BRUTALE 800/RR	13' - 16'	6	9038N	(*)
DRAGSTER 800/RR	14' - 16'	6	9038N	(*)
RIVALE 800	13' - 16'	6	9038N	(*)
SUZUKI				
GSF650 BANDIT	05' - 14'	5	4611N	(*)
GSF650S BANDIT	05' - 14'	5	4612N	(*)
GSR600	05' - 13'	5	4612N	(*)
GSR750	11' - 16'	5	4612N	(*)
GSX-S750	17' - 18'	5	4612N	(*)
GSX-R600	04' - 17'	5	4611N	(*)
GSX-R750	04' - 17'	5	4611N	(*)
GSX-S1000	15' - 18'	5	4612N	(*)
GSX-S1000F	15' - 18'	5	4612N	(*)
INAZUMA	13' - 17'	5	4612N	(*)
GSX650	05' - 17'	5	4612N	(*)
GSF650	05'-17'	5	4612N	(*)
GSX.R250	17'-18'	5	4612N	(*)
GSX-R300	17'-18'	5	4612N	(*)
GSX-R150	18'		4611N	(*)
GSX-R1000	03' - 04'	5	4612N	(*)
GSX-R1000	05' - 18'	5	4611N	(*)

MODEL	YEAR	N° SCREWS	REF.	N
GSX-R1300 HAYABUSA	99' - 07'	7	6842N	(*)
GSX-R1300 HAYABUSA	08' - 15'	5	4612N	(*)
GSX-R750	93' - 03'	7	6842N	(*)
GSX-R600	98' - 03'	7	6842N	(*)
SV1000	00' - 03'	7	6842N	(*)
SV650	00' - 03'	7	6842N	(*)
GSF650 BANDIT	07' - 11'	7	6842N	(*)
GSF650S BANDIT	07' - 14'	7	6842N	(*)
SFV650 GLADIUS	09' - 15'	5	4612N	(*)
SV650	04' - 08'	5	4611N	(*)
SV650	16' - 17'	5	4612N	(*)
SV650X	18'	5	4612N	(*)
SV1000	04'-07'	5	4611N	(*)
GSX1250F	17'	5	4612N	(*)
BANDIT 1250F	17'	5	4612N	(*)
TRIUMPH				
DAYTONA 675/R	06' -18'	6	5148N	(*)
SPRINT ST	08' - 15'	6	5148N	(*)
DAYTONA 955i	02' - 06'	6	5148N	(*)
SPEED TRIPLE	08' - 18'	6	5148N	(*)
SPEED FOUR 600	00' - 06'	6	5148N	(*)
STREET TRIPLE/R	08' -18'	6	5148N	(*)
YAMAHA				
FZ6	04' - 06'	5	4616N	(*)
FZ6 FAZER	07' - 08'	5	4616N	(*)
FZ8	10' - 16'	5	4616N	(*)
FZ8 FAZER	10' - 12'	5	4616N	(*)
FAZER8	13' - 16'	5	4616N	(*)
FZ1/ FZ1 FAZER	06' - 15'	5	4616N	(*)
MT-01	05' - 13'	5	4616N	(*)
MT-03	06' - 14'	5	4616N	(*)
MT-09	13' - 18'	5	4616N	(*)
MT-10	16' - 18'	3	9039N	(*)
XJ6	09' - 16'	5	4616N	(*)
XJ6 DIVERSION	09' - 16'	5	4616N	(*)
XJ6 DIVERSION F	10' - 16'	5	4616N	(*)
YZF-R6	04' - 16'	5	4615N	(*)
YZF-R6	17' - 18'	5	9040N	(*)
YZF-R1	02' - 14'	5	4615N	(*)
YZF-R1	15' - 18'	3	9040N	(*)



N
Black

Made in light aluminium.

(*) Check price with your distributor.

IMPORTANT: Indicate code color after part#. Example: 0973A.

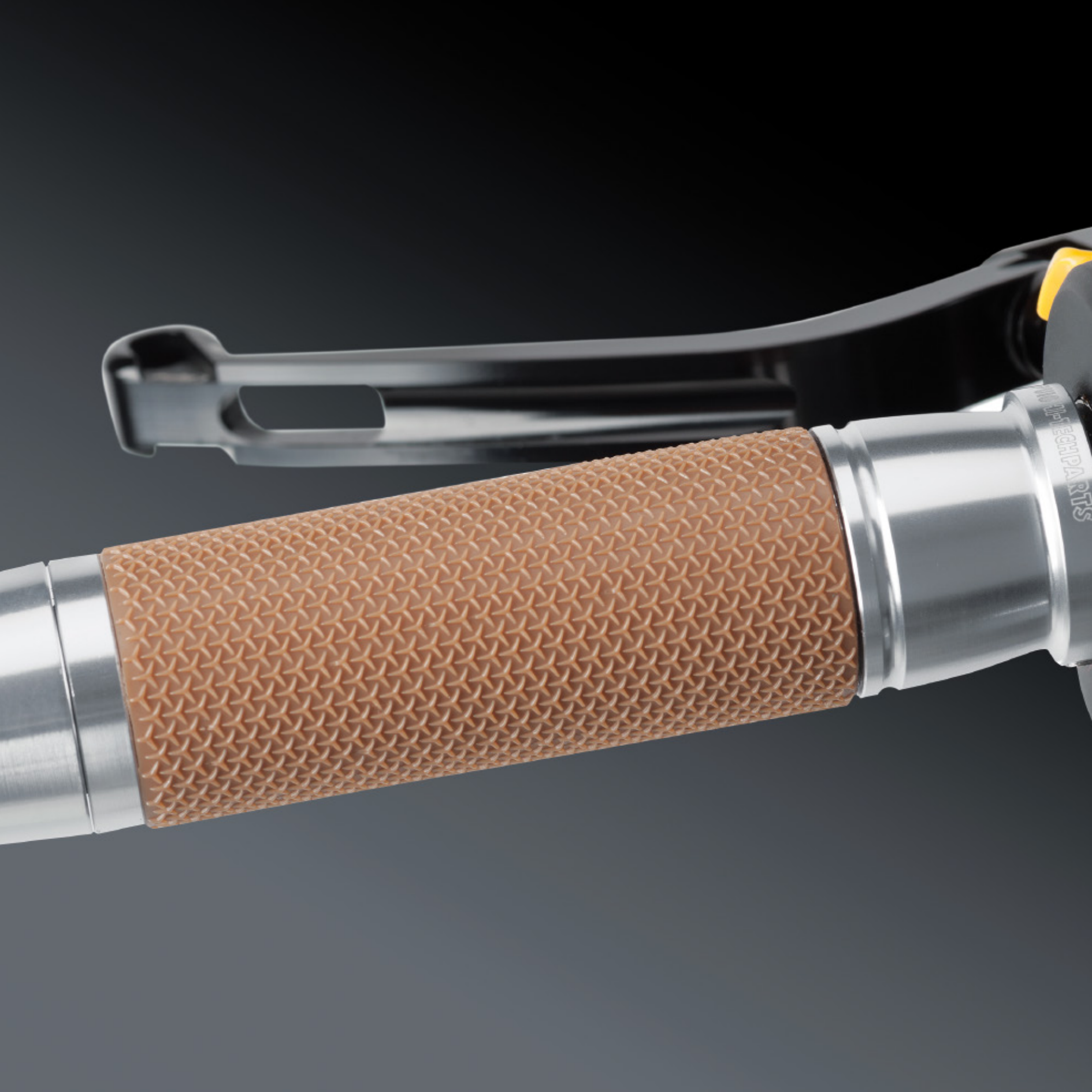

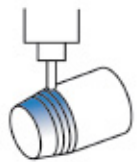

MATERIAL
 Manufactured from billet aluminium.

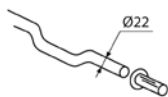

HANDLEBAR
 Suitable for diameter 22 mm.



RUBBER
 Non-skid texture.
 Pleasant compound.



WEIGHT
 94 grams.



THROTTLE ADAPTORS
 Included.



DIMENSIONS
 Length 119 mm.

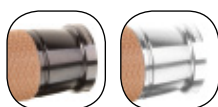

N
 Black

P
 Silver

MODEL	DIMENSIONS	REF.	N P
VINTAGE GRIPS BY PAIR	119 mm.	9190	(*)

GRIPS SUITABLE WITH THIS MODELS **SEE PAGE 506**

*** NOT SUITABLE WITH THE ELECTRONIC SYSTEM RIDE BY WIRE.**

(*) Check price with your distributor.

IMPORTANT: Indicate code color after part#. Example: 0973A.



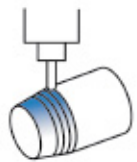

MATERIAL
Manufactured from billet aluminium.

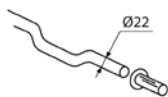

HANDLEBAR
Suitable for diameter 22 mm.



RUBBER
Non-skid texture.
Pleasant compound.



WEIGHT
94 grams.



THROTTLE ADAPTORS
Included.

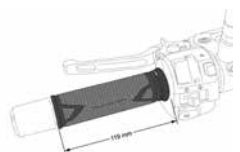

DIMENSIONS
Length 119 mm.



MODEL	DIMENSIONS	REF.	R O A T N P V
ASCENT GRIPS BY PAIR	119 mm.	6326	(*)

GRIPS SUITABLE WITH THIS MODELS **SEE PAGE 506**

*** NOT SUITABLE WITH THE ELECTRONIC SYSTEM RIDE BY WIRE.**

(*) Check price with your distributor.

IMPORTANT: Indicate code color after part#. Example: 0973A.

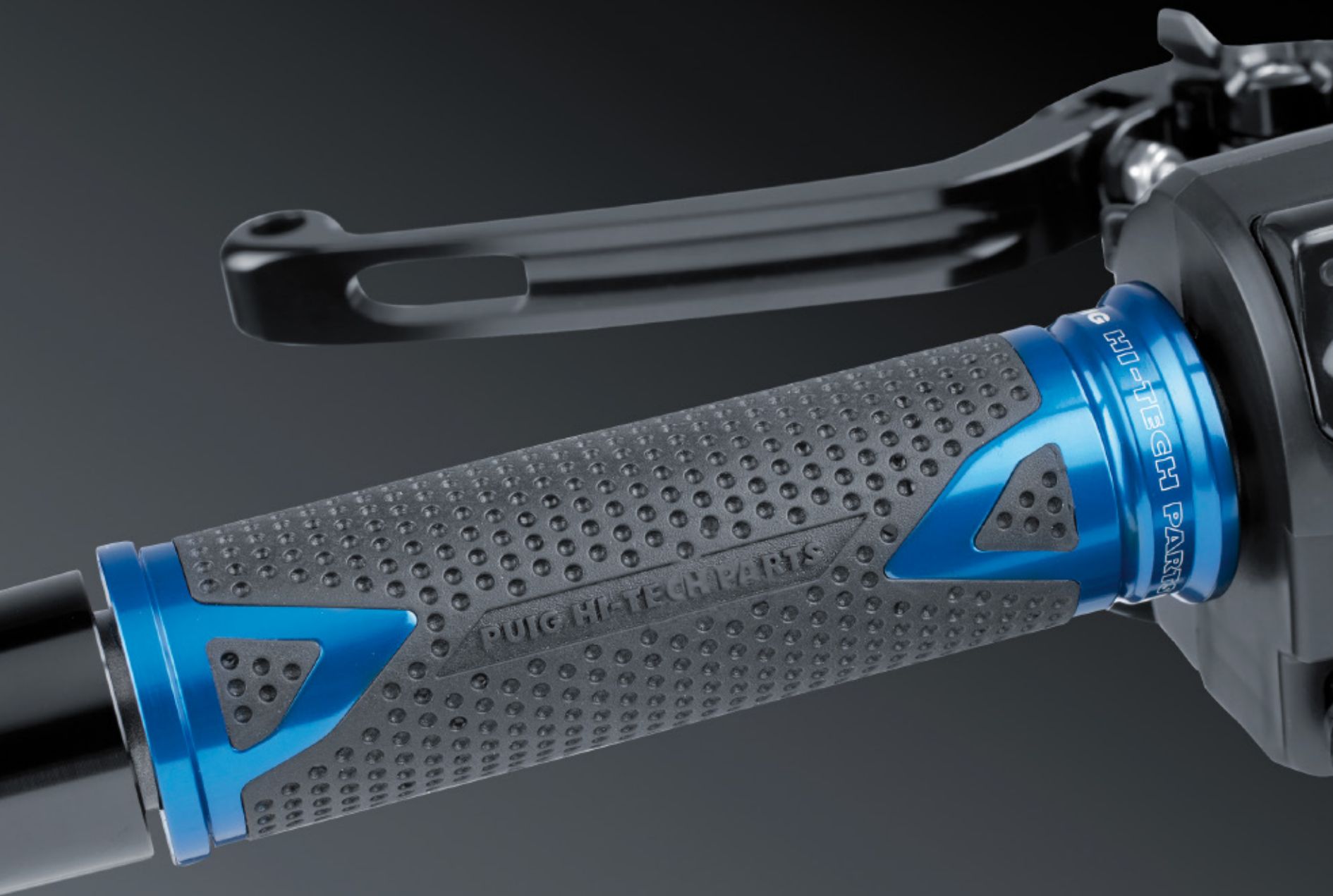

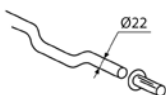

HANDLEBAR
Suitable for diameter
22 mm.



RUBBER
Non-skid texture.
Pleasant compound.

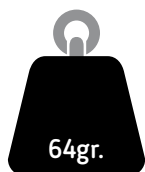

WEIGHT
64 grams.

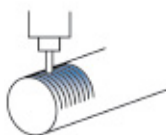

DETAIL
Aluminium anodized
insertion in different
colors.

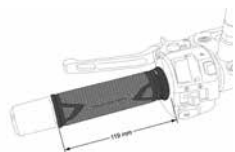

DIMENSIONS
Length 119 mm.

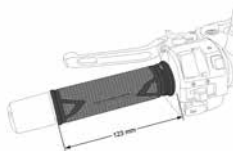

DIMENSIONS
Length 123 mm.



MODEL	DIMENSIONS	REF.	R D A T N P V C
RADIKAL GRIPS BY PAIR	119 mm.	6325	(*)
RADIKAL GRIPS BY PAIR	123 mm.	8191	(*)

GRIPS SUITABLE WITH THIS MODELS SEE PAGE 506

IMPORTANT: Due to the wide variety of original grips, some motorcycles may need to lower the edges of the gas throttle and the use of glue (such as Fischer MS Express) for a correct fixation. In motorcycle models where it is not possible to separate the rubber grip from the gas cane because they are one piece, it is not possible to install the grips.

*** NOT SUITABLE WITH THE ELECTRONIC SYSTEM RIDE BY WIRE.**

(*) Check price with your distributor.

IMPORTANT: Indicate code color after part#. Example: 0973A.



R Red **A** Blue **N** Black **P** Silver **O** Gold **V** Green **C** Carbon Look **T** Orange

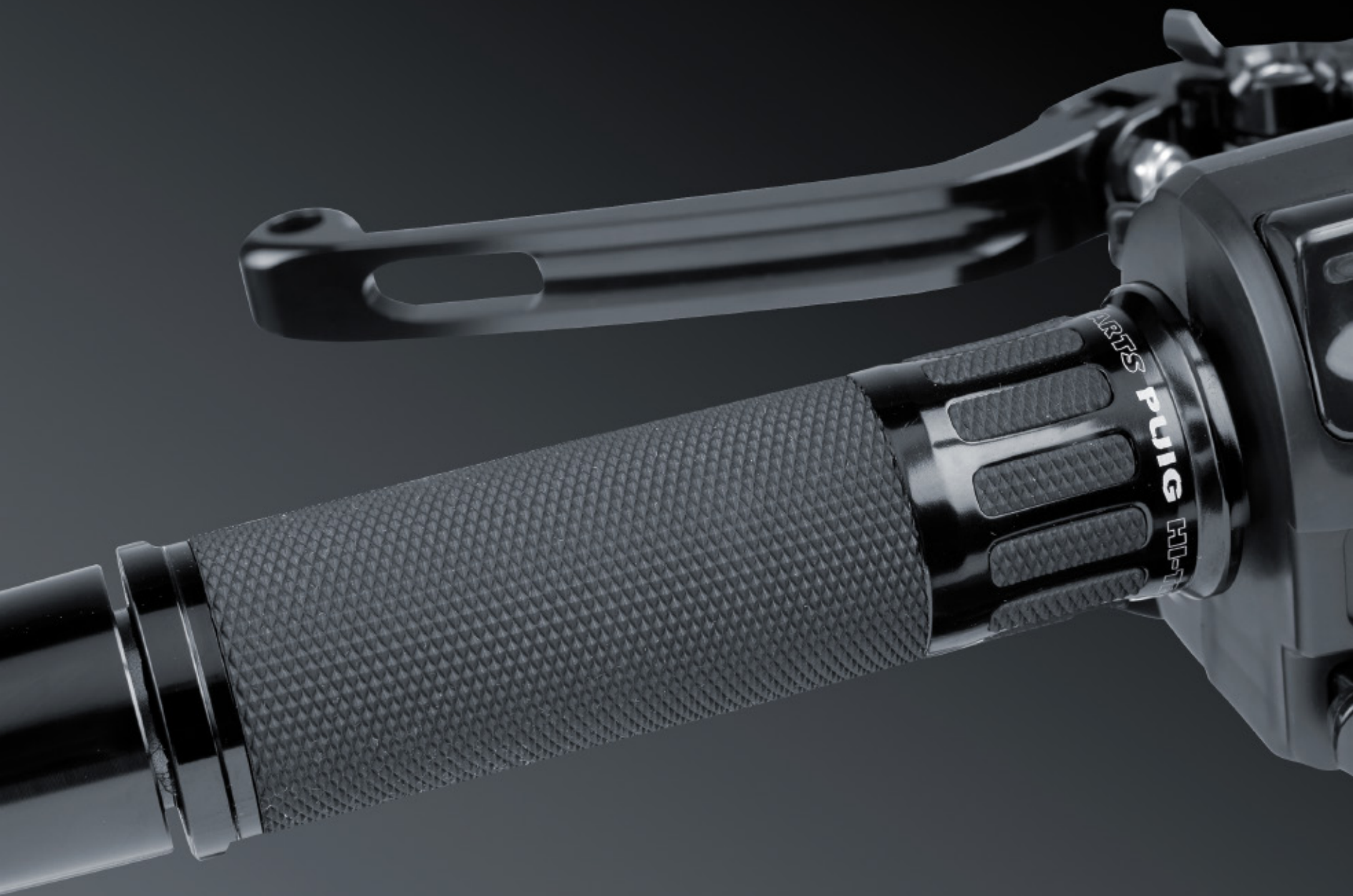

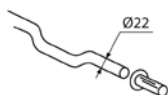

HANDLEBAR
 Suitable for diameter
 22 mm.



RUBBER
 Non-skid texture.
 Pleasant compound.



WEIGHT
 68 grams.

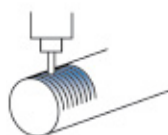

DETAIL
 Aluminium anodized
 insertion in different
 colors.

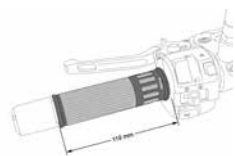

DIMENSIONS
 Length 119 mm.

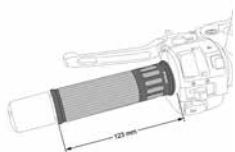

DIMENSIONS
 Length 123 mm.



MODEL	DIMENSIONS	REF.	R N	O P	A V	T C
RACING GRIPS BY PAIR	119 mm.	5879	(*)			
RACING GRIPS BY PAIR	123 mm.	8188	(*)			

GRIPS SUITABLE WITH THIS MODELS **SEE PAGE 506**

IMPORTANT: Due to the wide variety of original grips, some motorcycles may need to lower the edges of the gas throttle and the use of glue (such as Fischer MS Express) for a correct fixation. In motorcycle models where it is not possible to separate the rubber grip from the gas cane because they are one piece, it is not possible to install the grips.

*** NOT SUITABLE WITH THE ELECTRONIC SYSTEM RIDE BY WIRE.**

(*) Check price with your distributor.

IMPORTANT: Indicate code color after part#. Example: 0973A.



R Red **A** Blue **N** Black **P** Silver **O** Gold **V** Green **C** Carbon Look **T** Orange

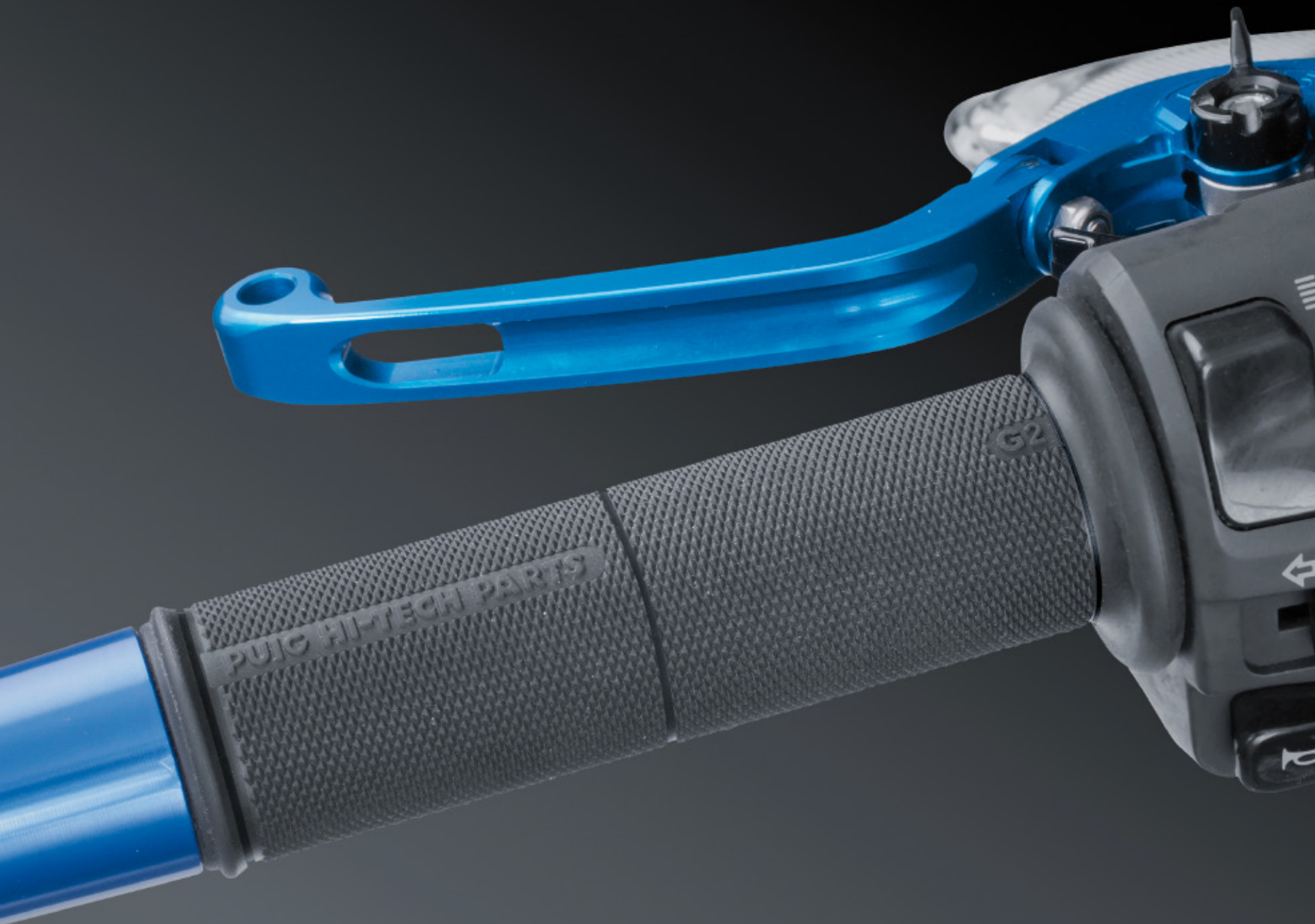

PUIG HI-TECH PARIS

G2

←

⏪

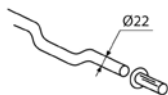

HANDLEBAR

Suitable for diameter
22 mm.



RUBBER

Non-skid texture.
Pleasant compound.

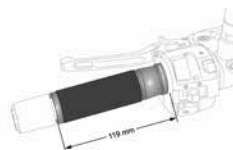

DIMENSIONS

Length 119 mm.



N
Black

MODEL	TACTO	REF.	N
GRIPS OPENED END BY PAIR	SOFT	6404N	(*)
GRIPS OPENED END BY PAIR	MEDIUM	6405N	(*)
GRIPS OPENED END BY PAIR	HARD	6406N	(*)

GRIPS SUITABLE WITH THIS MODELS **SEE PAGE 506**

IMPORTANT: Due to the wide variety of original grips, some motorcycles may need to lower the edges of the gas throttle and the use of glue (such as Fischer MS Express) for a correct fixation.

In motorcycle models where it is not possible to separate the rubber grip from the gas cane because they are one piece, it is not possible to install the grips.

*** NOT SUITABLE WITH THE ELECTRONIC SYSTEM RIDE BY WIRE.**

(*) Check price with your distributor.

IMPORTANT: Indicate code color after part#. Example: 0973A.



Puig

**ANTI-GLARE
GLASS**

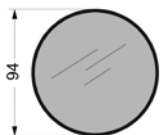

HOMOLOGATED
Ø 94 mm.

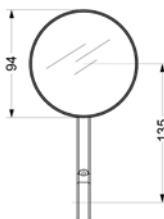

DIMENSIONS



ADAPTABLE

Specific available adapters for bike model.

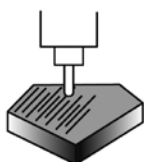

MATERIAL

Manufactured from billet aluminium and anodized.

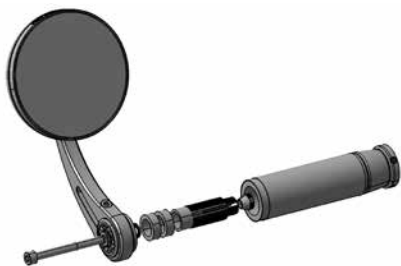

For handlebars with inner diameter of 13/18mm.



N

Black



D

Anodized Aluminium



MODEL	SIDE	REF.	N D
UNIVERSAL	RIGHT	9691	(*)
UNIVERSAL	LEFT	9691	(*)

SEE PAGE 582 TO SEE PART# FOR THE ADAPTORS ON THE MODELS AVAILABLE.

IMPORTANT: Indicate code color after part#. Example: 0973A.



**ANTI-GLARE
 GLASS**

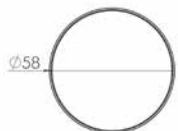

NOT HOMOLOGATED:
 Ø 58 mm.

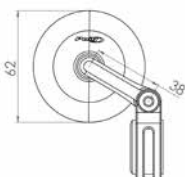

ADJUSTABLE
 Inclination and height.

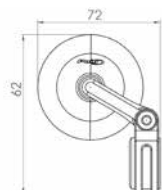

ADAPTABLE
 To handlebar bar end.

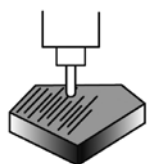

MATERIAL
 Manufactured from
 billet aluminium and
 anodized.



ADAPTABLE
 Specific adapters
 available for certain
 bike models.

For handlebars with inner diameter of 13/18mm.



N
 Black



D
 Anodized Aluminium



MODEL	SIDE	REF.	N D
UNIVERSAL	RIGHT	9506	(*)
UNIVERSAL	LEFT	9506	(*)

SEE PAGE 582 TO SEE PART# FOR THE ADAPTORS ON THE MODELS AVAILABLE.

IMPORTANT: Indicate code color after part#. Example: 0973A.



**ANTI-GLARE
GLASS**

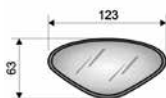

NOT HOMOLOGATED

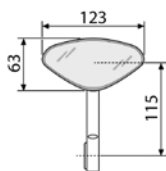

DIMENSIONS



ADAPTABLE

Specific adapters available for certain bike models.

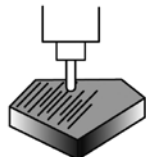

MATERIAL

Manufactured from billet aluminium and anodized.



For handlebars with inner diameter of 13/18mm.



N

Black



D

Anodized Aluminium

MODEL	SIDE	REF.	N D
UNIVERSAL	RIGHT	6994	(*)
UNIVERSAL	LEFT	6994	(*)

SEE PAGE 582 TO SEE PART# FOR THE ADAPTORS ON THE MODELS AVAILABLE.

IMPORTANT: Indicate code color after part#. Example: 0973A.



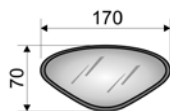

NOT HOMOLOGATED

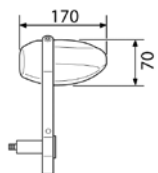

DIMENSIONS



ADAPTABLE

Specific adapters available for certain bike models.

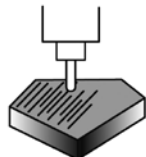

MATERIAL

Manufactured from billet aluminium and anodized.



For handlebars with inner diameter of 13/18mm.

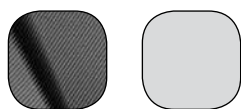

N
Black

P
Silver

MODEL	SIDE	REF.	N	P
UNIVERSAL	RIGHT	5220	(*)	(*)
UNIVERSAL	LEFT	5220	(*)	(*)

SEE PAGE 582 TO SEE PART# FOR THE ADAPTORS ON THE MODELS AVAILABLE.

IMPORTANT: Indicate code color after part#. Example: 0973A.

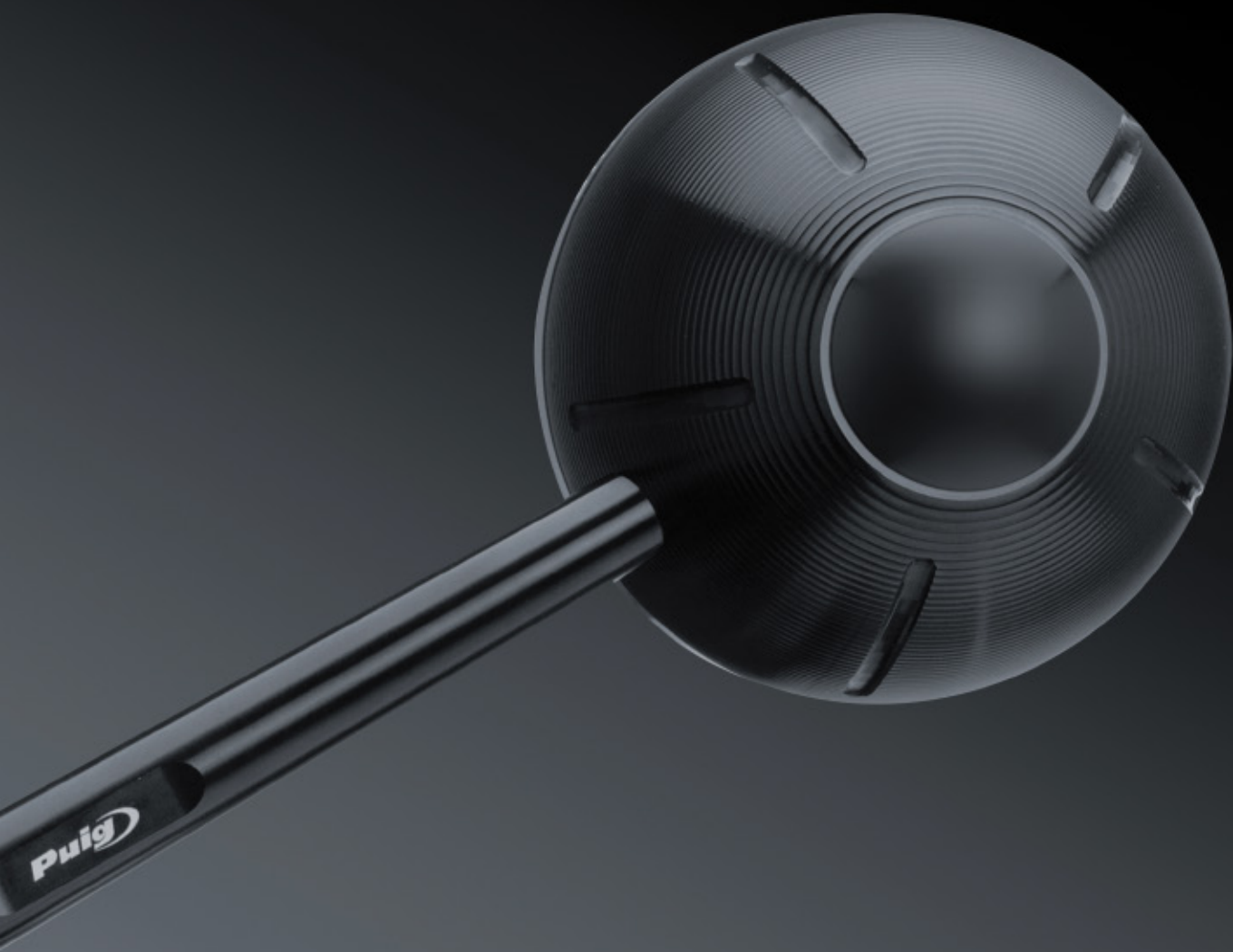

**ANTI GLARE
GLASS**

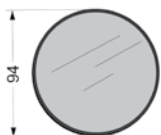

HOMOLOGATED
Ø 94 mm.

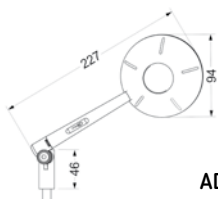

ADJUSTABLE
Inclination and height.

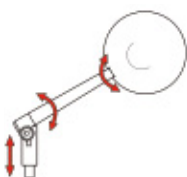

ADAPTABLE
To the handlebar and
adapters available for
the original fairing.

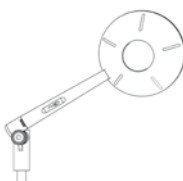

MATERIAL
Manufactured from
billet aluminium and
anodized.

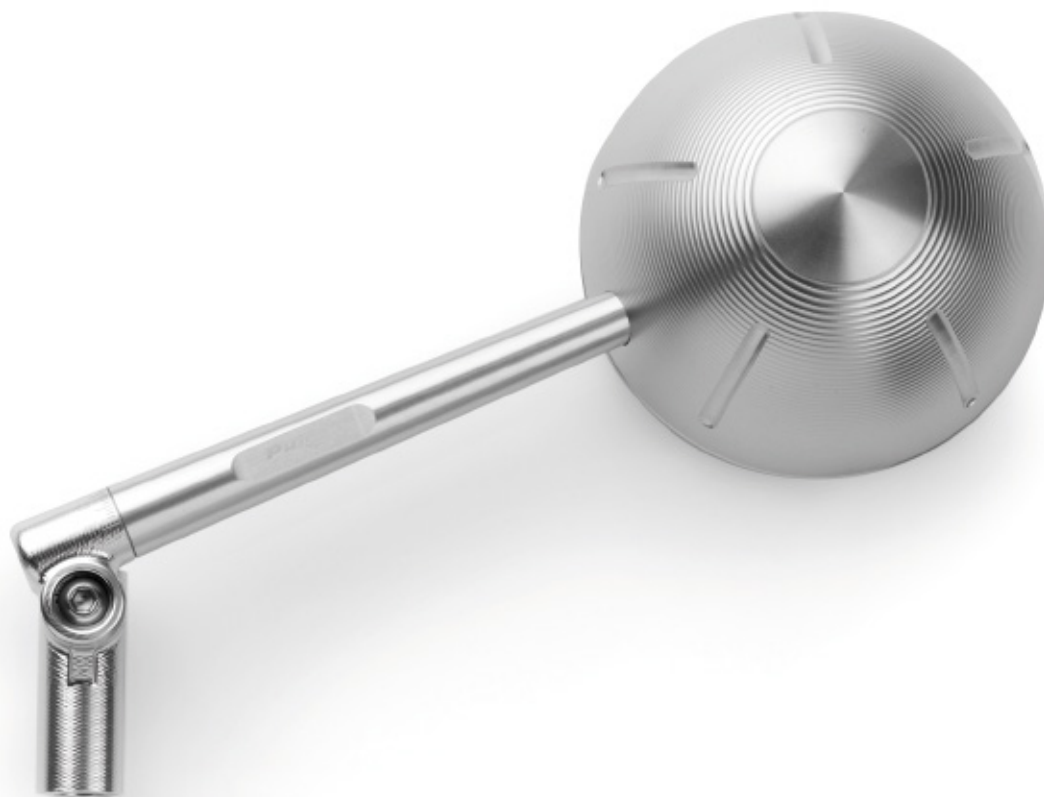
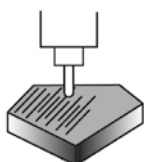

N

Black

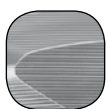

D

Anodized Aluminium

MODEL	SIDE	REF.	N D
UNIVERSAL	RIGHT	9794 (#)	(*)
UNIVERSAL	LEFT	9795	(*)

FOR THOSE MODELS REQUIRING ADAPTOR TO HANDLEBAR **SEE PAGE 534**
FOR THOSE MODELS REQUIRING ADAPTORS TO ATTACH TO THE FAIRING **SEE PAGE 560**

(#) KIT ADAPTER DELIVERED: M10 x 1,25 (reverse thread).

IMPORTANT: Indicate code color after part#. Example: 0973A.



**ANTI GLARE
GLASS**

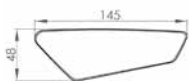

NOT HOMOLOGATED:
145 x 48 mm.

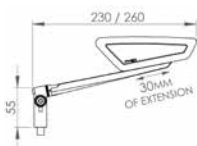

ADJUSTABLE
Inclination, adjustment,
and extension of the
mirror.

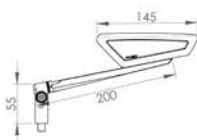
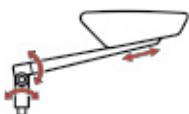

ADAPTABLE
Available adapters for
handlebar and fairing
fitting.

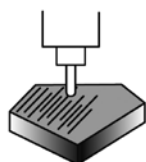

MATERIAL
Manufactured from
billet aluminium and
anodized.



N
Black



D
Anodized Aluminium

MODEL	SIDE	REF.	N D
UNIVERSAL THREAD M10	RIGHT	9883 (#)	(*)
UNIVERSAL THREAD M10	LEFT	9884	(*)

FOR THOSE MODELS REQUIRING ADAPTOR TO HANDLEBAR **SEE PAGE 534**
 FOR THOSE MODELS REQUIRING ADAPTORS TO ATTACH TO THE FAIRING **SEE PAGE 560**

(#) KIT ADAPTER DELIVERED: M10 x 1,25 (reverse thread).

IMPORTANT: Indicate code color after part#. Example: 0973A.

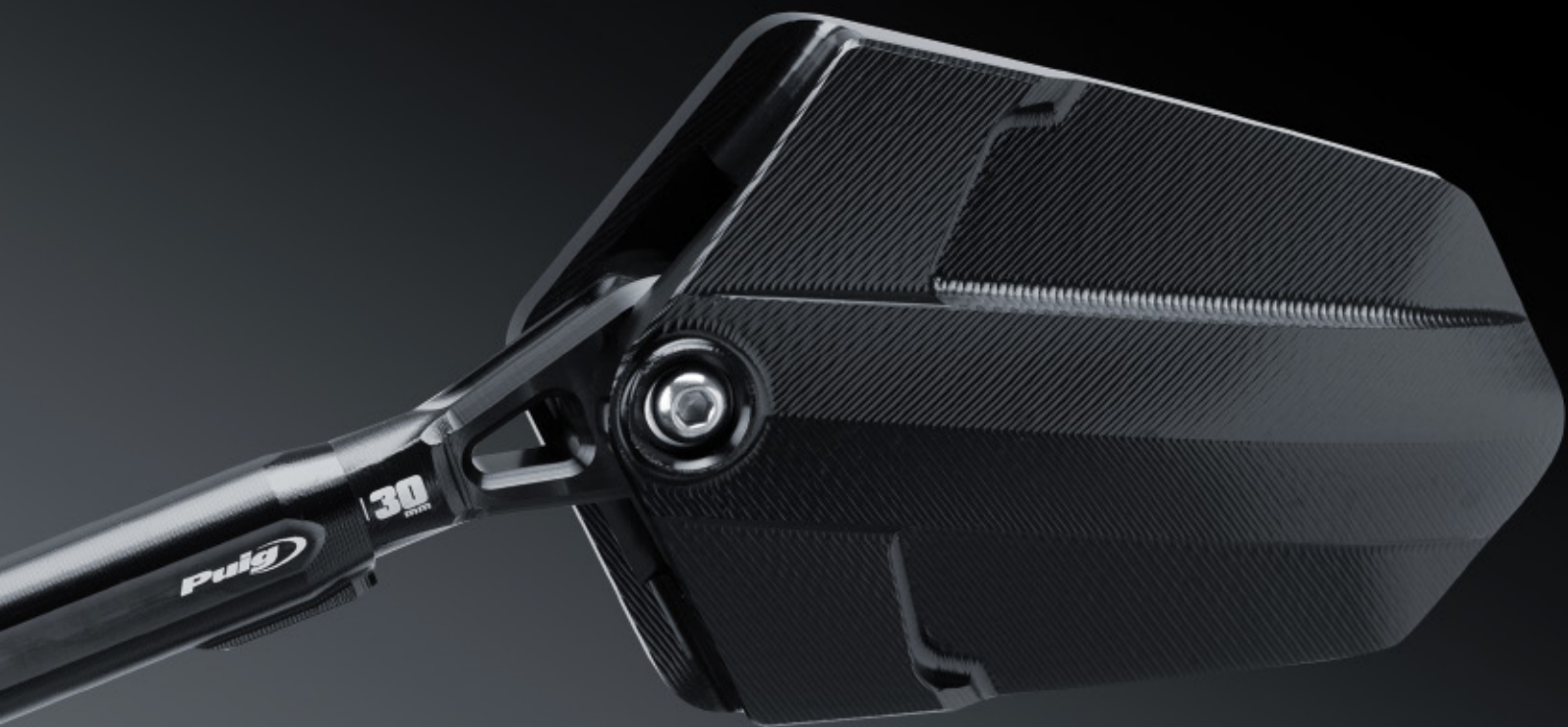

ANTI-GLARE GLASS

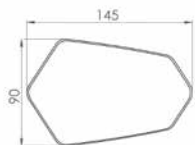

HOMOLOGATED:
145 x 90 mm.

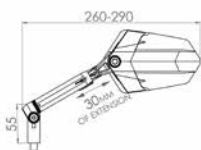

ADJUSTABLE
Inclination, adjustment,
and extension of the mirror.

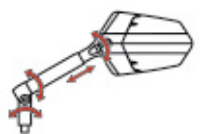

ADAPTABLE
Available adapters for
handlebar and fairing
fitting.

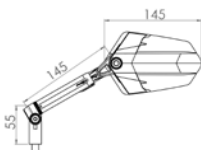

MATERIAL
Manufactured from
billet aluminium and
anodized.

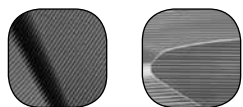
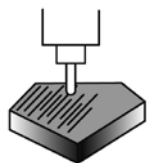

N Black
D Anodized Aluminium

MODEL	SIDE	REF.	N	D
UNIVERSAL THREAD M10	RIGHT	010NN (1) (#)	(*)	
UNIVERSAL THREAD M10	RIGHT	010DD (2) (#)	(*)	
UNIVERSAL THREAD M10	RIGHT	010DN (3) (#)	(*)	
UNIVERSAL THREAD M10	RIGHT	010ND (4) (#)	(*)	
UNIVERSAL THREAD M10	LEFT	014NN (1)	(*)	
UNIVERSAL THREAD M10	LEFT	014DD (2)	(*)	
UNIVERSAL THREAD M10	LEFT	014DN (3)	(*)	
UNIVERSAL THREAD M10	LEFT	014ND (4)	(*)	

FOR THOSE MODELS REQUIRING ADAPTOR TO HANDLEBAR **SEE PAGE 534**
FOR THOSE MODELS REQUIRING ADAPTORS TO ATTACH TO THE FAIRING **SEE PAGE 560**

(#) KIT ADAPTER DELIVERED: M10 x 1,25 (reverse thread).

IMPORTANT: Indicate code color after part#. Example: 0973A.



**ANTI GLARE
GLASS**

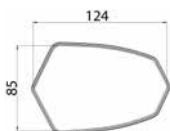

HOMOLOGATED

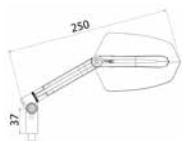

ADJUSTABLE
Inclination and height.

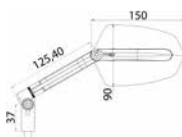
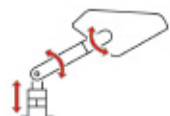

ADAPTABLE
Available adapters for
handlebar and fairing
fitting.

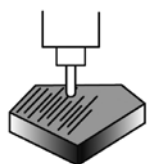

MATERIAL
Manufactured from
billet aluminium and
anodized.

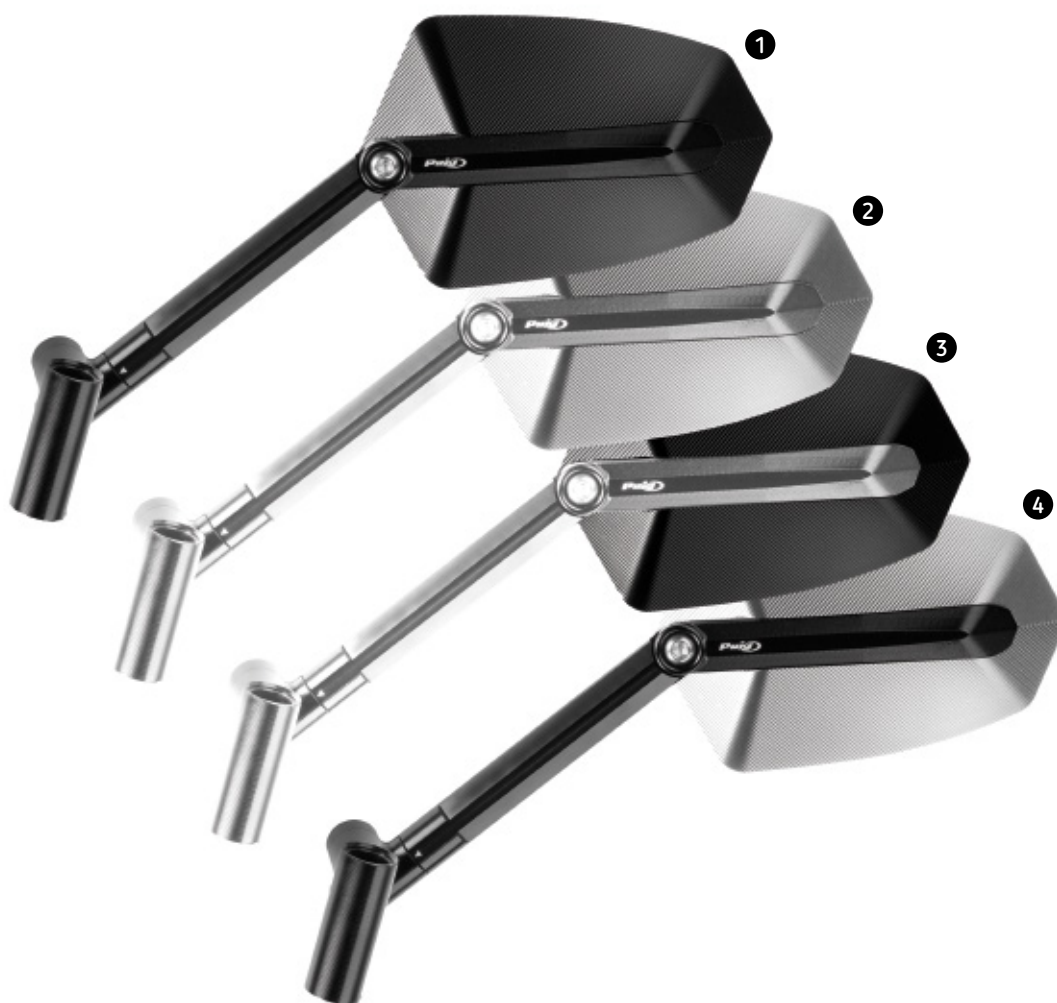

MODEL	SIDE	REF.	N	D
UNIVERSAL THREAD M10	RIGHT	002NN (1) (#)		(*)
UNIVERSAL THREAD M10	RIGHT	002DD (2) (#)		(*)
UNIVERSAL THREAD M10	RIGHT	002DN (3) (#)		(*)
UNIVERSAL THREAD M10	RIGHT	002ND (4) (#)		(*)
UNIVERSAL THREAD M10	LEFT	001NN (1)		(*)
UNIVERSAL THREAD M10	LEFT	001DD (2)		(*)
UNIVERSAL THREAD M10	LEFT	001DN (3)		(*)
UNIVERSAL THREAD M10	LEFT	001ND (4)		(*)

FOR THOSE MODELS REQUIRING ADAPTOR TO HANDLEBAR **SEE PAGE 534**
FOR THOSE MODELS REQUIRING ADAPTORS TO ATTACH TO THE FAIRING **SEE PAGE 560**

(#) KIT ADAPTER DELIVERED: M10 x 1,25 (reverse thread).

IMPORTANT: Indicate code color after part#. Example: 0973A.



N

Black



D

Anodized Aluminium

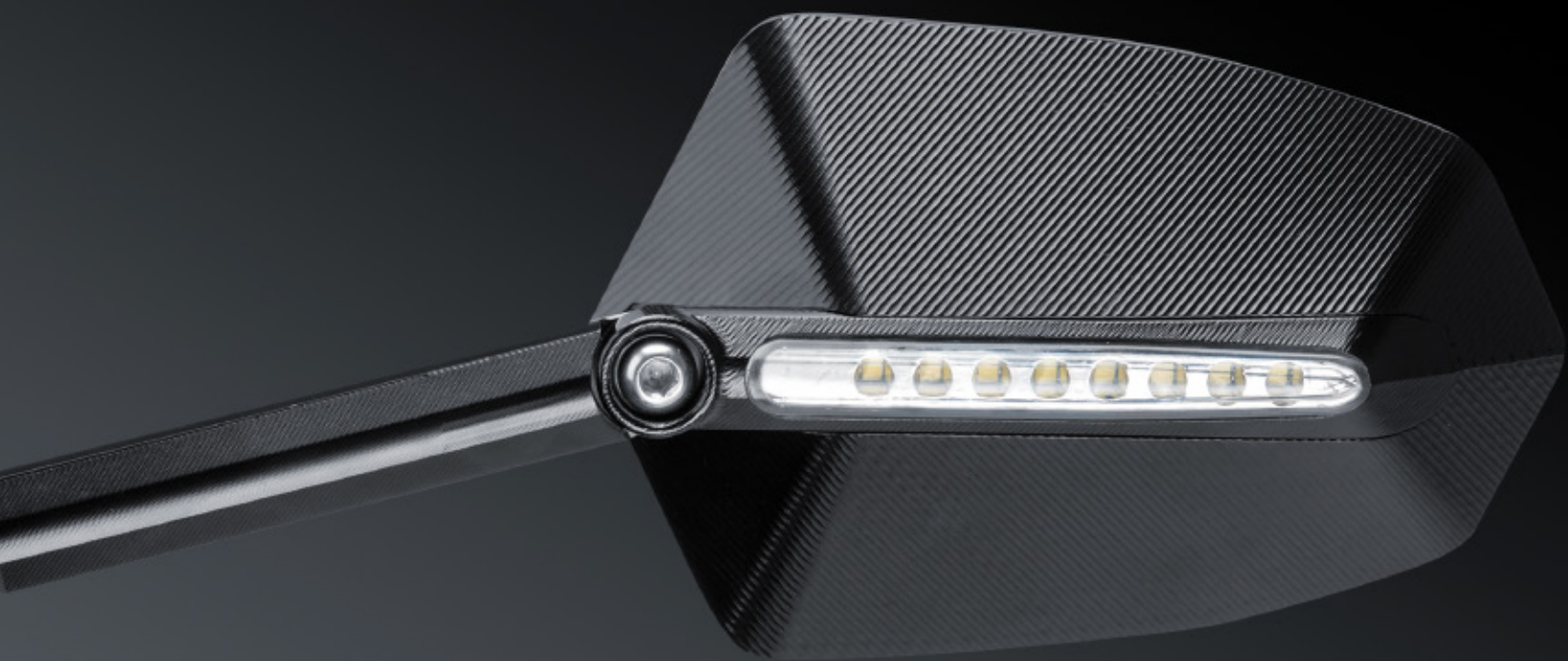

**ANTI GLARE
GLASS**

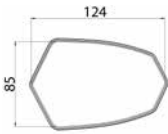

HOMOLOGATED

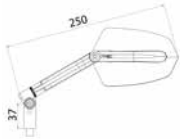

ADJUSTABLE
Inclination and height.

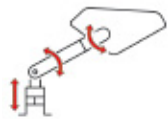

ADAPTABLE
Available adapters for
handlebar and fairing
fitting.

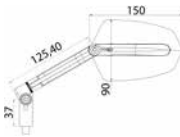

MATERIAL
Manufactured from
billet aluminium and
anodized.

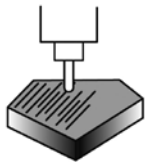

**TURN SIGNAL
INTEGRATED**

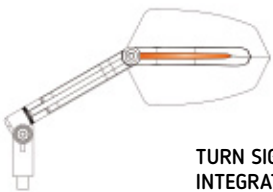

N
Black



D
Anodized Aluminium



MODEL	SIDE	REF.	N	D
UNIVERSAL THREAD M10	RIGHT	015NN (1) (#)		(*)
UNIVERSAL THREAD M10	RIGHT	015DD (2) (#)		(*)
UNIVERSAL THREAD M10	RIGHT	015DN (3) (#)		(*)
UNIVERSAL THREAD M10	RIGHT	015ND (4) (#)		(*)
UNIVERSAL THREAD M10	LEFT	016NN (1)		(*)
UNIVERSAL THREAD M10	LEFT	016DD (2)		(*)
UNIVERSAL THREAD M10	LEFT	016DN (3)		(*)
UNIVERSAL THREAD M10	LEFT	016ND (4)		(*)

FOR THOSE MODELS REQUIRING ADAPTOR TO HANDLEBAR **SEE PAGE 534**
FOR THOSE MODELS REQUIRING ADAPTORS TO ATTACH TO THE FAIRING **SEE PAGE 560**

(#) KIT ADAPTER DELIVERED: M10 x 1,25 (reverse thread).

IMPORTANT: Indicate code color after part#. Example: 0973A.

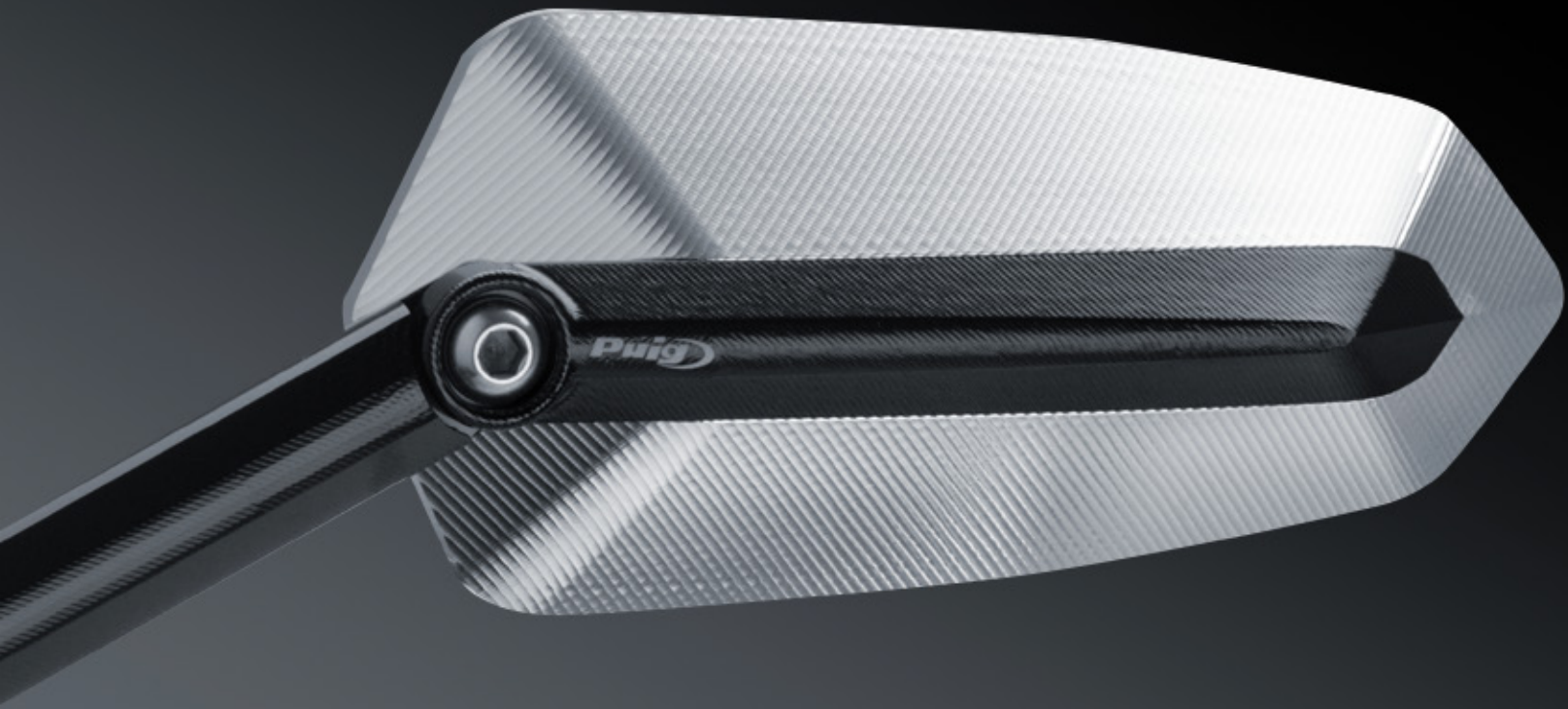

**ANTI GLARE
GLASS**

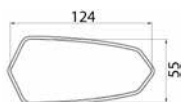

NOT HOMOLOGATED

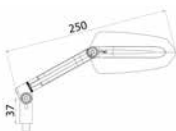

ADJUSTABLE
Inclination and height.

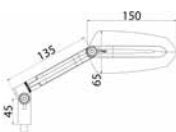
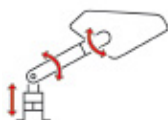

ADAPTABLE
Available adapters for
handlebar and fairing
fitting.

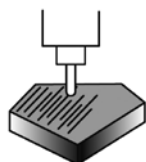

MATERIAL
Manufactured from
billet aluminium and
anodized.



N
Black



D
Anodized Aluminium

MODEL	SIDE	REF.	N	D
UNIVERSAL THREAD M10	RIGHT	009NN (1) (#)		(*)
UNIVERSAL THREAD M10	RIGHT	009DD (2) (#)		(*)
UNIVERSAL THREAD M10	RIGHT	009DN (3) (#)		(*)
UNIVERSAL THREAD M10	RIGHT	009ND (4) (#)		(*)
UNIVERSAL THREAD M10	LEFT	008NN (1)		(*)
UNIVERSAL THREAD M10	LEFT	008DD (2)		(*)
UNIVERSAL THREAD M10	LEFT	008DN (3)		(*)
UNIVERSAL THREAD M10	LEFT	008ND (4)		(*)

FOR THOSE MODELS REQUIRING ADAPTOR TO HANDLEBAR **SEE PAGE 534**
FOR THOSE MODELS REQUIRING ADAPTORS TO ATTACH TO THE FAIRING **SEE PAGE 560**

(#) KIT ADAPTER DELIVERED: M10 x 1,25 (reverse thread).

IMPORTANT: Indicate code color after part#. Example: 0973A.



Puig

ARTS

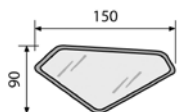

HOMOLOGATED

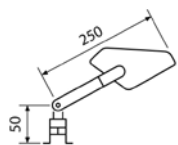

ADJUSTABLE
 Inclination and height.

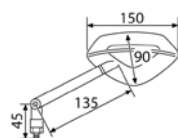
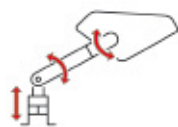

ADAPTABLE
 Available adapters for handlebar and fairing fitting.

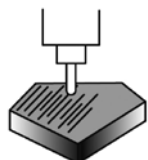

MATERIAL
 Manufactured from billet aluminium and anodized.



N
 Black



D
 Anodized Aluminium

MODEL	SIDE	REF.	N D
UNIVERSAL THREAD M10 TO HANDLEBAR	RIGHT	6218 (#)	(*)
UNIVERSAL THREAD M10 TO HANDLEBAR	LEFT	6217	(*)

FOR THOSE MODELS REQUIRING ADAPTOR TO HANDLEBAR **SEE PAGE 534**
 FOR THOSE MODELS REQUIRING ADAPTORS TO ATTACH TO THE FAIRING **SEE PAGE 560**

(#) KIT ADAPTER DELIVERED: M10 x 1,25 (reverse thread).

IMPORTANT: Indicate code color after part#. Example: 0973A.



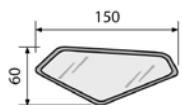

NOT HOMOLOGATED

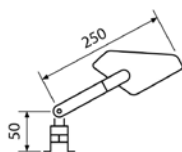

ADJUSTABLE
 Inclination and height.

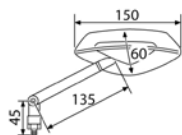
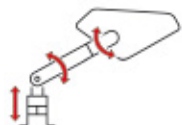

ADAPTABLE
 Available adapters for handlebar and fairing fitting.

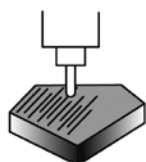

MATERIAL
 Manufactured from billet aluminium and anodized.



N
 Black



D
 Anodized Aluminium

MODEL	SIDE	REF.	N D
UNIVERSAL THREAD M10	RIGHT	6220 (#)	(*)
UNIVERSAL THREAD M10	LEFT	6219	(*)

FOR THOSE MODELS REQUIRING ADAPTOR TO HANDLEBAR **SEE PAGE 534**
 FOR THOSE MODELS REQUIRING ADAPTORS TO ATTACH TO THE FAIRING **SEE PAGE 560**

(#) KIT ADAPTER DELIVERED: M10 x 1,25 (reverse thread).

IMPORTANT: Indicate code color after part#. Example: 0973A.

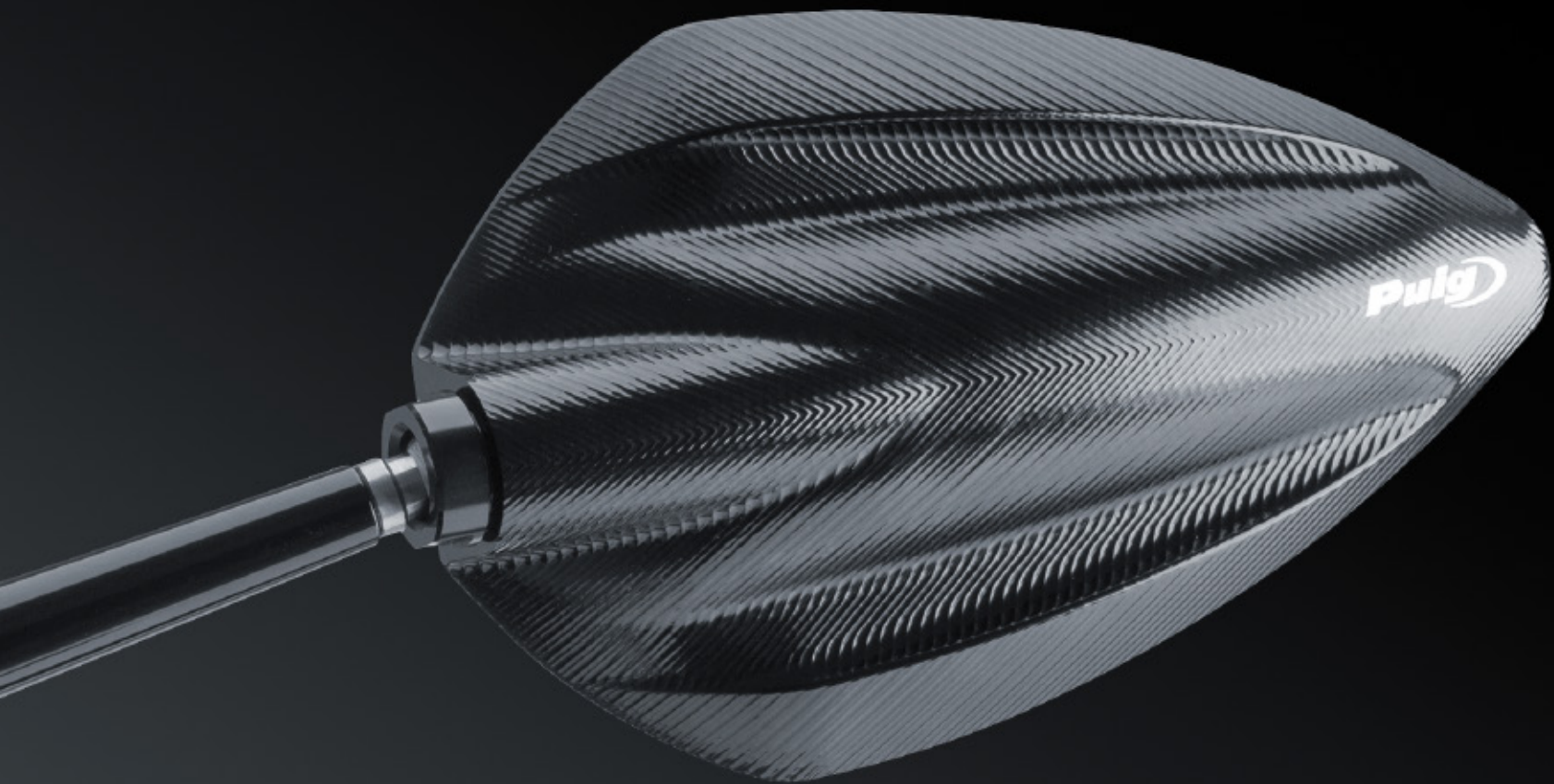

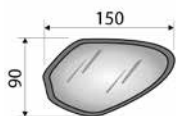

HOMOLOGATED

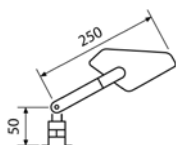

ADJUSTABLE
 Inclination and height.

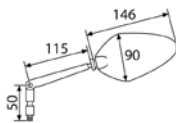
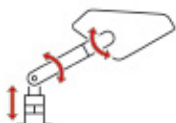

ADAPTABLE
 Available adapters for handlebar and fairing fitting.

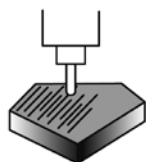

MATERIAL
 Manufactured from billet aluminium and anodized.



N
 Black



D
 Anodized Aluminium

MODEL	SIDE	REF.	N D
UNIVERSAL THREAD M10	RIGHT	8025 (#)	(*)
UNIVERSAL THREAD M10	LEFT	8036	(*)

FOR THOSE MODELS REQUIRING ADAPTOR TO HANDLEBAR **SEE PAGE 534**
 FOR THOSE MODELS REQUIRING ADAPTORS TO ATTACH TO THE FAIRING **SEE PAGE 560**

(#) KIT ADAPTER DELIVERED: M10 x 1,25 (reverse thread).

IMPORTANT: Indicate code color after part#. Example: 0973A.



// RS1

MODEL	SIDE	REF.	N	C
(1) UNIVERSAL WITH BAR	RIGHT	7340 (#)		(*)
(1) UNIVERSAL WITH BAR	LEFT	7341 (#)		(*)
(2) UNIVERSAL 30° FAIRING FITTING	RIGHT	7342		(*)
(2) UNIVERSAL 30° FAIRING FITTING	LEFT	7343		(*)
(3) UNIVERSAL FAIRING FITTING	RIGHT	7344		(*)
(3) UNIVERSAL FAIRING FITTING	LEFT	7345		(*)
(4) UNIVERSAL 70° FAIRING FITTING	RIGHT	7346		(*)
(4) UNIVERSAL 70° FAIRING FITTING	LEFT	7347		(*)

HOMOLOGATED

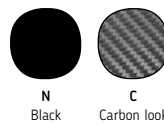

(#) KIT ADAPTER DELIVERED: M10x1,25RH, 10x1,25LH, M8x1,25RH, M8x1,25LH
REAR MIRROR WITH PLASTIC BASE.

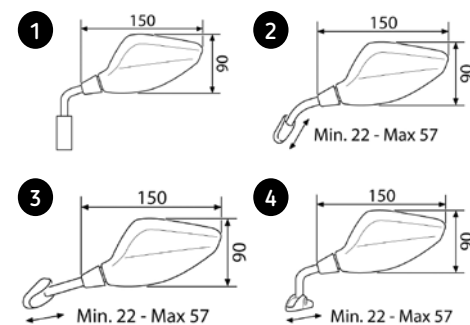

FOR THOSE MODELS REQUIRING ADAPTOR TO HANDLEBAR SEE PAGE 534
FOR THOSE MODELS REQUIRING ADAPTOR TO ATTACH TO THE FAIRING SEE PAGE 560

(*) Check price with your distributor.

IMPORTANT: Indicate code color after part#. Example: 0973A.



// RS2

MODEL	SIDE	REF.	N	C
(1) UNIVERSAL WITH BAR	RIGHT	7348 (#)		(*)
(1) UNIVERSAL WITH BAR	LEFT	7349 (#)		(*)
(2) UNIVERSAL 30° FAIRING FITTING	RIGHT	7350		(*)
(2) UNIVERSAL 30° FAIRING FITTING	LEFT	7351		(*)
(3) UNIVERSAL FAIRING FITTING	RIGHT	7352		(*)
(3) UNIVERSAL FAIRING FITTING	LEFT	7353		(*)
(4) UNIVERSAL 70° FAIRING FITTING	RIGHT	7354		(*)
(4) UNIVERSAL 70° FAIRING FITTING	LEFT	7355		(*)

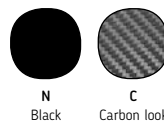
NOT HOMOLOGATED

(#) KIT ADAPTER DELIVERED: M10x1,25RH,
10x1,25LH, M8x1,25RH, M8x1,25LH
REAR MIRROR WITH PLASTIC BASE.

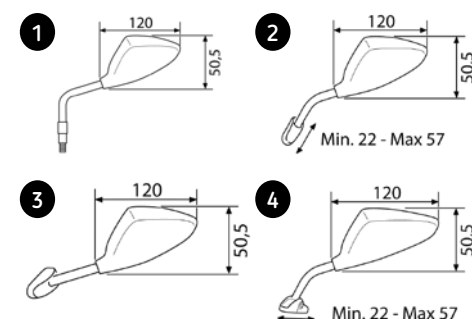

(*) Check price with your distributor.

IMPORTANT: Indicate code color after part#. Example: 0973A.

FOR THOSE MODELS REQUIRING ADAPTOR TO HANDLEBAR SEE PAGE 534
FOR THOSE MODELS REQUIRING ADAPTOR TO ATTACH TO THE FAIRING SEE PAGE 560



// MT

MODEL	SIDE	REF.	N
UNIVERSAL THREAD M10	RIGHT	4310 (#)	(*)
UNIVERSAL THREAD M10	LEFT	4311	(*)

NOT HOMOLOGATED

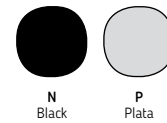

REAR MIRROR WITH METALLIC BASE.

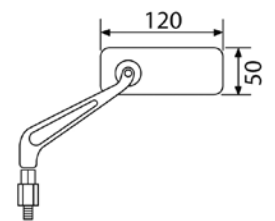

(#) KIT ADAPTER DELIVERED: M10 x 1,25 (reverse thread).
 FOR THOSE MODELS REQUIRING ADAPTOR TO HANDLEBAR SEE PAGE 534

(*) Check price with your distributor.
IMPORTANT: Indicate code color after part#. Example: 0973A.



// MG

MODEL	SIDE	REF.	N
UNIVERSAL THREAD M10	RIGHT	4497 (#)	(*)
UNIVERSAL THREAD M10	LEFT	4498	(*)

NOT HOMOLOGATED



N
Black

REAR MIRROR WITH ALUMINIUM BASE.

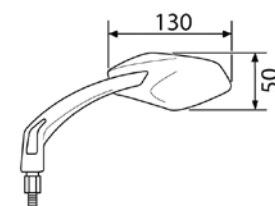

(#) KIT ADAPTER DELIVERED: M10 x 1,25 (reverse thread).

FOR THOSE MODELS REQUIRING ADAPTOR TO HANDLEBAR SEE PAGE 534

(*) Check price with your distributor.

IMPORTANT: Indicate code color after part#. Example: 0973A.



// Z1

MODEL	SIDE	REF.	Ⓒ
(1) UNIVERSAL THREAD M10 TO HANDLEBAR	RIGHT	4306 (#)	(*)
(1) UNIVERSAL THREAD M10 TO HANDLEBAR	LEFT	4307	(*)
(2) FAIRING FITTING	RIGHT	4251	(*)
(2) FAIRING FITTING	LEFT	4252	(*)

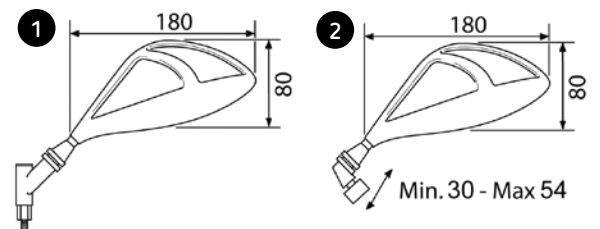
HOMOLOGATEDc
Carbon lookREAR MIRROR WITH
CARBON LOOK BASE.(#) **KIT ADAPTER DELIVERED:** M10 x 1,25 (reverse thread).FOR THOSE MODELS REQUIRING ADAPTOR TO HANDLEBAR **SEE PAGE 534**

(*) Check price with your distributor.

IMPORTANT: Indicate code color after part#. Example: 0973A.



// CLUTCH COVER

MODEL	YEAR	REF.	A N O R P
YAMAHA			
T-MAX 530	12' - 16'	8501	(*)
T-MAX 530/DX/SX	17'	9855	(*)



// SPROCKET COVER

MODEL	YEAR	REF.	A N O R P
KYMCO			
AK550	17'	9547	(*)
YAMAHA			
T-MAX 530	12' - 16'	8502	(*)
T-MAX/DX/SX	17'	8502	(*)



// BRAKE LIQUID TANK COVER

MODEL	YEAR	REF.	A N O R P
YAMAHA			
T-MAX 530	12' - 16'	7356	(*)
T-MAX/DX/SX	17'	7356	(*)



// SHAFT RING TRIM

MODEL	YEAR	REF.	A N O R P
KYMCO			
AK550	17'	9546	(*)
YAMAHA			
T-MAX 530	12' - 16'	7359	(*)
T-MAX/DX/SX	17'	9854	(*)



A Blue N Black O Gold R Red P Silver

(*) Check price with your distributor.

IMPORTANT: Indicate code color after part#. Example: 0973A.

YAMAHA T-MAX 530 / KYMCO AK550

HI-TECH PARTS

2019
MODELS:
www.puig.tv



// SHAFT COVER

MODEL	YEAR	REF.	N
KYMCO			
AK550	17'	9543	(*)
YAMAHA			
T-MAX 530	12' - 16'	6336	(*)
T-MAX 530/DX/SX	17'	9455	(*)



// PARKING BRAKE LEVER

MODEL	YEAR	REF.	A N O R P
KYMCO			
AK550	17'	9544	(*)
YAMAHA			
T-MAX 530	12' - 16'	8500	(*)
T-MAX 530/DX/SX	17'	8500	(*)



// BASE CAPS FOR OEM REAR MIRRORS BY PAIR

MODEL	YEAR	REF.	A N O R
YAMAHA			
T-MAX 530	12' - 16'	7511	(*)
T-MAX 530/DX/SX	17'	7511	(*)

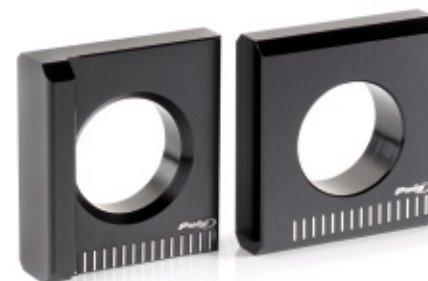

// TENSORS FOR REAR WHEEL BY PAIR

MODEL	YEAR	REF.	A N O R P
KYMCO			
AK550	17'	9545	(*)
YAMAHA			
T-MAX 530	12' - 16'	7357	(*)
T-MAX 530/DX/SX	17'	7357	(*)



A Blue **N** Black **O** Gold **R** Red **P** Silver

(*) Check price with your distributor.

IMPORTANT: Indicate code color after part#. Example: 0973A.



// END TUBE FOR EXHAUST

MODEL	YEAR	REF.	A N O R
KYMCO			
AK550	17'	9542	(*)
YAMAHA			
T-MAX 530	12' - 16'	7358	(*)
T-MAX/DX/SX	17'	CHECK WEB	



// ADAPTOR TO AXLE LEVER

MODEL	YEAR	REF.	N
YAMAHA			
T-MAX 530	12' - 16'	7517	(*)
T-MAX 530/DX/SX	17'	7517 (#)	(*)

(#) PARA T-MAX 530/SX/DX 17' COMPATIBLE SÓLO PARA V-TECH LINES SPORT/TOURING PUIG



// KEY CONTACT PROTECTOR

MODEL	YEAR	REF.	C
YAMAHA			
T-MAX 530	12' - 16'	8071	(*)
T-MAX/DX/SX	17'	CHECK WEB	

// STICKER KIT

MODEL	YEAR	REF.	N O B
YAMAHA			
T-MAX 530 (1)	15' - 16'	8153N	(*)
T-MAX 530 (2)	15' - 16'	8154B	(*)
T-MAX 530 (3)	15' - 16'	81550	(*)
T-MAX 530 (4)	15' - 16'	81610	(*)
T-MAX/DX/SX (5)	17' - 18'	9565N	(*)
T-MAX/DX/SX (6)	17' - 18'	9566B	(*)
T-MAX/DX/SX (7)	17' - 18'	95670	(*)
T-MAX/DX/SX (8)	17' - 18'	95680	(*)
T-MAX/DX/SX (8)	17' - 18'	9550A	(*)

SEE PAGE 320



A Blue N Black O Gold R Red C Carbon Look B White

(*) Check price with your distributor.

IMPORTANT: Indicate code color after part#. Example: 0973A.

YAMAHA T-MAX 530 / STICKER KIT
HI-TECH PARTS

2019
MODELS:
www.puig.tv

1



2



3



4



5



6



7



8





// CITY SPORT

MODEL	REFERENCE	PRICE
UNIVERSAL (REAR MIRROR M8)	0661	(*)

FOR SPECIFIC MODELS SEE PAGE 608

(*) Check price with your distributor.

IMPORTANT: Indicate code color after part#. Example: 0973A.



H
Smoke



460 mm

2 FIXATION POINTS

330 mm



// CITY TOURING

MODEL	REFERENCE	PRICE
UNIVERSAL (REAR MIRROR M8)	0572	(*)

FOR SPECIFIC MODELS SEE PAGE 608

(*) Check price with your distributor.

IMPORTANT: Indicate code color after part#. Example: 0973A.



H
Smoke

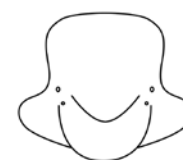

620 mm

450 mm

2 FIXATION POINTS



// TRAFIC

MODEL	REFERENCE	PRICE
UNIVERSAL	4873	(*)

FOR SPECIFIC MODELS SEE PAGE 608

(*) Check price with your distributor.

IMPORTANT: Indicate code color after part#. Example: 0973A.



W
Transparent



H
Smoke

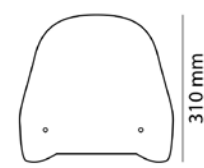

370 mm

310 mm

2 FIXATION POINTS



// URBAN

MODEL	REFERENCE	PRICE
UNIVERSAL	7599	(*)

FOR SPECIFIC MODELS SEE PAGE 608

(*) Check price with your distributor.

IMPORTANT: Indicate code color after part#. Example: 0973A.



W
Transparent



H
Smoke

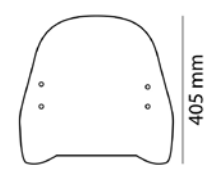

390 mm

2 FIXATION POINTS



// T.S.

MODEL	REFERENCE	PRICE
UNIVERSAL	6371	(*)

FOR SPECIFIC MODELS SEE PAGE 608

(*) Check price with your distributor.

IMPORTANT: Indicate code color after part#. Example: 0973A.



W
Transparent



480 mm

510 mm

2 FIXATION POINTS



// T.X.

MODEL	REFERENCE	PRICE
UNIVERSAL	1952	(*)

FOR SPECIFIC MODELS SEE PAGE 608

(*) Check price with your distributor.

IMPORTANT: Indicate code color after part#. Example: 0973A.



W
Transparent



555 mm

510 mm

2 FIXATION POINTS



// HAND GUARDS

MODEL	REFERENCE	PRICE
HAND GUARDS UNIVERSAL	6855	(*)

FOR SPECIFIC MODELS SEE PAGE 608

(*) Check price with your distributor.

IMPORTANT: Indicate code color after part#. Example: 0973A.



W
Transparent





// NAKED

MODEL	REFERENCE	PRICE
UNIVERSAL	0869	(*)

FOR SPECIFIC MODELS SEE WEBSITE

(*) Check price with your distributor.

IMPORTANT: Indicate code color after part#. Example: 0973A.



A
Blue

N
Black



H
Smoke

F
Dark Smoke



2 FIXATION POINTS



// RAPTOR

MODEL	REF.	A R H N W F
UNIVERSAL	0013	(*)

FOR SPECIFIC MODELS SEE WEBSITE

(*) Check price with your distributor.

IMPORTANT: Indicate code color after part#. Example: 0973A.

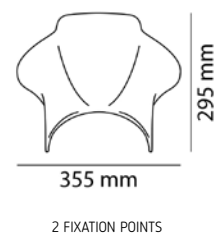



// COCKPIT

MODEL	REF.	A	R	H	N	W	F	G
UNIVERSAL	1480							

(*)

FOR SPECIFIC MODELS SEE WEBSITE

(*) Check price with your distributor.

IMPORTANT: Indicate code color after part#. Example: 0973A.



TÜV

ABE
38188

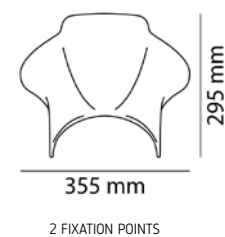



// WAVE

MODEL	REF.	A	R	H	N	F	C
UNIVERSAL	2208						

(*) (*) (*) (*) (*) (*) (*)

FOR SPECIFIC MODELS SEE WEBSITE

(*) Check price with your distributor.

IMPORTANT: Indicate code color after part#. Example: 0973A.

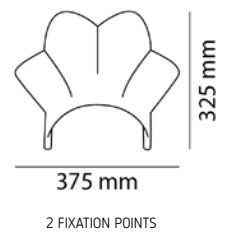



// TRACK

MODEL	REF.	A	R	H	N	W	F	G	Y
UNIVERSAL	4120								

(*)

(*)

FOR SPECIFIC MODELS SEE WEBSITE

(*) Check price with your distributor.

IMPORTANT: Indicate code color after part#. Example: 0973A.



R

Red



G

Yellow



A

Blue



N

Black



H

Smoke



F

Dark Smoke



Y

Iridium



TÜV

ABE
38188

310 mm

365 mm

2 FIXATION POINTS



// WINDY

MODEL	REFERENCE	PRICE
UNIVERSAL	1482	(*)

FOR SPECIFIC MODELS SEE WEBSITE

(*) Check price with your distributor.

IMPORTANT: Indicate code color after part#. Example: 0973A.

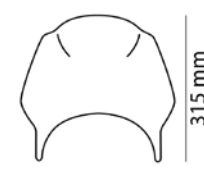

355 mm

2 FIXATION POINTS



// VISION

MODEL	REFERENCE	PRICE
UNIVERSAL	003CX	(*)
UNIVERSAL	003NX	(*)

REFERENCE NOMENCLATURE

FOR SPECIFIC MODELS SEE WEBSITE

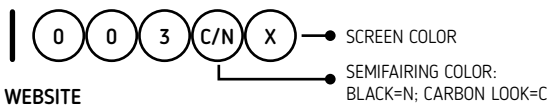

TÜV

ABE
38188

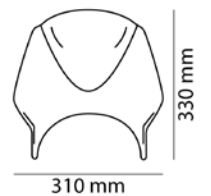

2 FIXATION POINTS



// TOP

MODEL	REFERENCE	PRICE
UNIVERSAL	1309	(*)

FOR SPECIFIC MODELS SEE WEBSITE

(*) Check price with your distributor.

IMPORTANT: Indicate code color after part#. Example: 0973A.



N
Black



H
Smoke

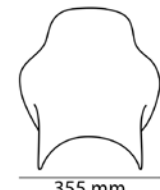

355 mm

390 mm

2 FIXATION POINTS



// PLUS

MODEL	REFERENCE	PRICE
UNIVERSAL	4620	(*)

FOR SPECIFIC MODELS SEE WEBSITE

(*) Check price with your distributor.

IMPORTANT: Indicate code color after part#. Example: 0973A.



F
Dark Smoke



H
Smoke

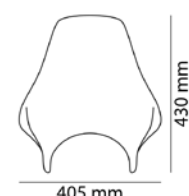

2 FIXATION POINTS



// THUNDER

MODEL	REFERENCE	PRICE
UNIVERSAL	0121	(*)

FOR SPECIFIC MODELS SEE WEBSITE

(*) Check price with your distributor.

IMPORTANT: Indicate code color after part#. Example: 0973A.



N
Black

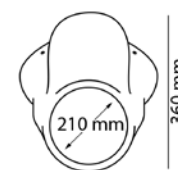

380 mm

360 mm

2 FIXATION POINTS



// CUSTOM I

MODEL	REFERENCE	PRICE
UNIVERSAL	0840	(*)

FOR SPECIFIC MODELS [SEE WEBSITE](#)

SPECIFIC MULTI-ADJUSTABLE VISOR FOR THIS WINDSHIELD [CHECK WEB](#)

(*) Check price with your distributor.

IMPORTANT: Indicate code color after part#. Example: 0973A.



W
Transparent



H
Smoke



360 mm

410 mm

4 FIXATION POINTS

340



// CUSTOM II

MODEL	REFERENCE	PRICE
UNIVERSAL	0336	(*)

FOR SPECIFIC MODELS [SEE WEBSITE](#)

SPECIFIC MULTI-ADJUSTABLE VISOR FOR THIS WINDSHIELD [CHECK WEB](#)

(*) Check price with your distributor.

IMPORTANT: Indicate code color after part#. Example: 0973A.



W
Transparent



H
Smoke

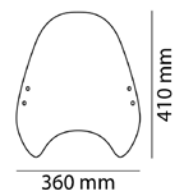

2 FIXATION POINTS



// CUSTOM II WITH VISOR

MODEL	REFERENCE	PRICE
UNIVERSAL	5921	(*)

FOR SPECIFIC MODELS SEE WEBSITE

(*) Check price with your distributor.

IMPORTANT: Indicate code color after part#. Example: 0973A.



H
Smoke



360 mm

410 mm

2 FIXATION POINTS



// RANGER

MODEL	REFERENCE	PRICE
UNIVERSAL	0328	(*)

FOR SPECIFIC MODELS [SEE WEBSITE](#)
 SPECIFIC MULTI-ADJUSTABLE VISOR FOR THIS WINDSHIELD [CHECK WEB](#)

(*) Check price with your distributor.

IMPORTANT: Indicate code color after part#. Example: 0973A.



H
Smoke



510 mm

510 mm

4 FIXATION POINTS



// TOURING I

MODEL	REFERENCE	PRICE
UNIVERSAL	0856	(*)

FOR SPECIFIC MODELS [SEE WEBSITE](#)

SPECIFIC MULTI-ADJUSTABLE VISOR FOR THIS WINDSHIELD [CHECK WEB](#)

(*) Check price with your distributor.

IMPORTANT: Indicate code color after part#. Example: 0973A.



W
Transparent



530 mm

540 mm

2 FIXATION POINTS



// ROADSTER

MODEL	REFERENCE	PRICE
UNIVERSAL A	0444	(*)
UNIVERSAL B	0131	(*)
UNIVERSAL C	5932	(*)

FIXATIONS ON FRONT FORKS

FIXATIONS ON LIGHT SCREWS

HANDLEBAR FIXATIONS OF 22/26 mm.

FOR SPECIFIC MODELS SEE WEBSITE

IMPORTANT: Indicate code color after part#. Example: 0973A.



W
Transparent



H
Smoke



260 mm

290 mm

2 FIXATION POINTS



// CHOPPER

MODEL	REF.	PRICE
UNIVERSAL HANDLEBAR 22 / 26 mm.	0856	(*)

FOR SPECIFIC MODELS SEE WEBSITE

(*) Check price with your distributor.

IMPORTANT: Indicate code color after part#. Example: 0973A.



W
Transparent



H
Smoke

TÜV

ABE
38007

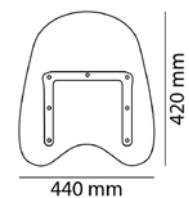

2 FIXATION POINTS



// HIGHWAY

MODEL	REF.	W	H
UNIVERSAL HANDLEBAR 22 / 26 mm.	0129	(*)	(*)

FOR SPECIFIC MODELS [SEE WEBSITE](#)

EASY-MOUNTING WINDSHIELD THROUGH 2 HANDLEBAR CLAMPS.

IF YOU ARE LOOKING FOR A MORE TIGHT FIXATION, WE RECOMMEND OUR WINDSHIELDS MODEL AMERICA WITH 4 MOUNTING POINTS.

IMPORTANT: Indicate code color after part#. Example: 0973A.



W
Transparent



H
Smoke

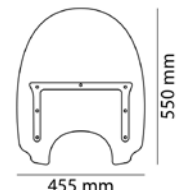

2 FIXATION POINTS



// DAYTONA IV

MODEL	REF.	PRICE
UNIVERSAL HANDLEBAR 22 / 26 mm.	2003	(*)

FOR SPECIFIC MODELS [SEE WEBSITE](#)

EASY-MOUNTING WINDSHIELD THROUGH 2 HANDLEBAR CLAMPS.

IF YOU ARE LOOKING FOR A MORE TIGHT FIXATION, WE RECOMMEND OUR WINDSHIELDS MODEL AMERICA WITH 4 MOUNTING POINTS.

IMPORTANT: Indicate code color after part#. Example: 0973A.



W
Transparent

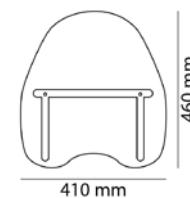

2 FIXATION POINTS



// DAYTONA III

MODEL	REF.	PRICE
UNIVERSAL HANDLEBAR 22 / 26 mm.	1984	(*)

FOR SPECIFIC MODELS [SEE WEBSITE](#)

EASY-MOUNTING WINDSHIELD THROUGH 2 HANDLEBAR CLAMPS.

IF YOU ARE LOOKING FOR A MORE TIGHT FIXATION, WE RECOMMEND OUR WINDSHIELDS MODEL AMERICA WITH 4 MOUNTING POINTS.

IMPORTANT: Indicate code color after part#. Example: 0973A.



W
Transparent



480 mm

2 FIXATION POINTS



// AMERICA I

MODEL	REFERENCE	PRICE
UNIVERSAL	0867	(*)

FOR SPECIFIC MODELS SEE WEBSITE

(*) Check price with your distributor.

IMPORTANT: Indicate code color after part#. Example: 0973A.



W
Transparent



455 mm

650 mm

4 FIXATION POINTS

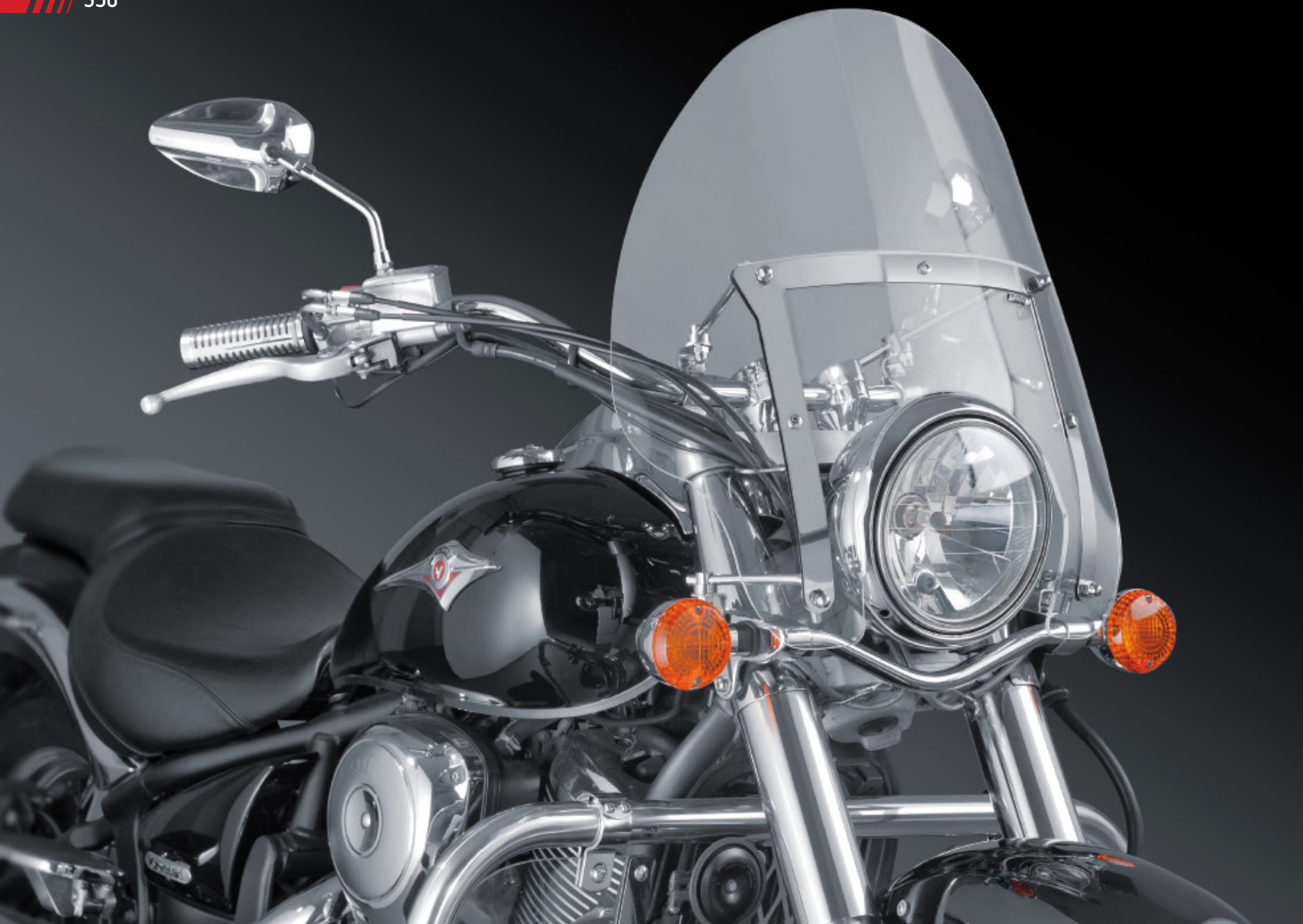

// AMERICA II

MODEL	REFERENCE	PRICE
UNIVERSAL	0319	(*)

FOR SPECIFIC MODELS SEE WEBSITE

(*) Check price with your distributor.

IMPORTANT: Indicate code color after part#. Example: 0973A.



W
Transparent



560 mm

560 mm

4 FIXATION POINTS



// AMERICA III

MODEL	REFERENCE	PRICE
UNIVERSAL	1129	(*)

FOR SPECIFIC MODELS SEE WEBSITE

(*) Check price with your distributor.

IMPORTANT: Indicate code color after part#. Example: 0973A.



W
Transparent

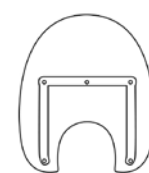

580 mm

710 mm

4 FIXATION POINTS



// CALIFORNIA

FOR SPECIFIC MODELS SEE WEBSITE

IMPORTANT: Indicate code color after part#. Example: 0973A.



W
Transparent

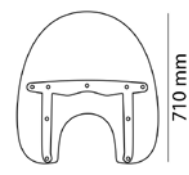

580 mm

710 mm

4 FIXATION POINTS



// SUNSET

FOR SPECIFIC MODELS SEE WEBSITE

IMPORTANT: Indicate code color after part#. Example: 0973A.



W
Transparent

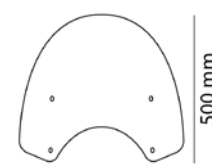

555 mm

500 mm

4 FIXATION POINTS

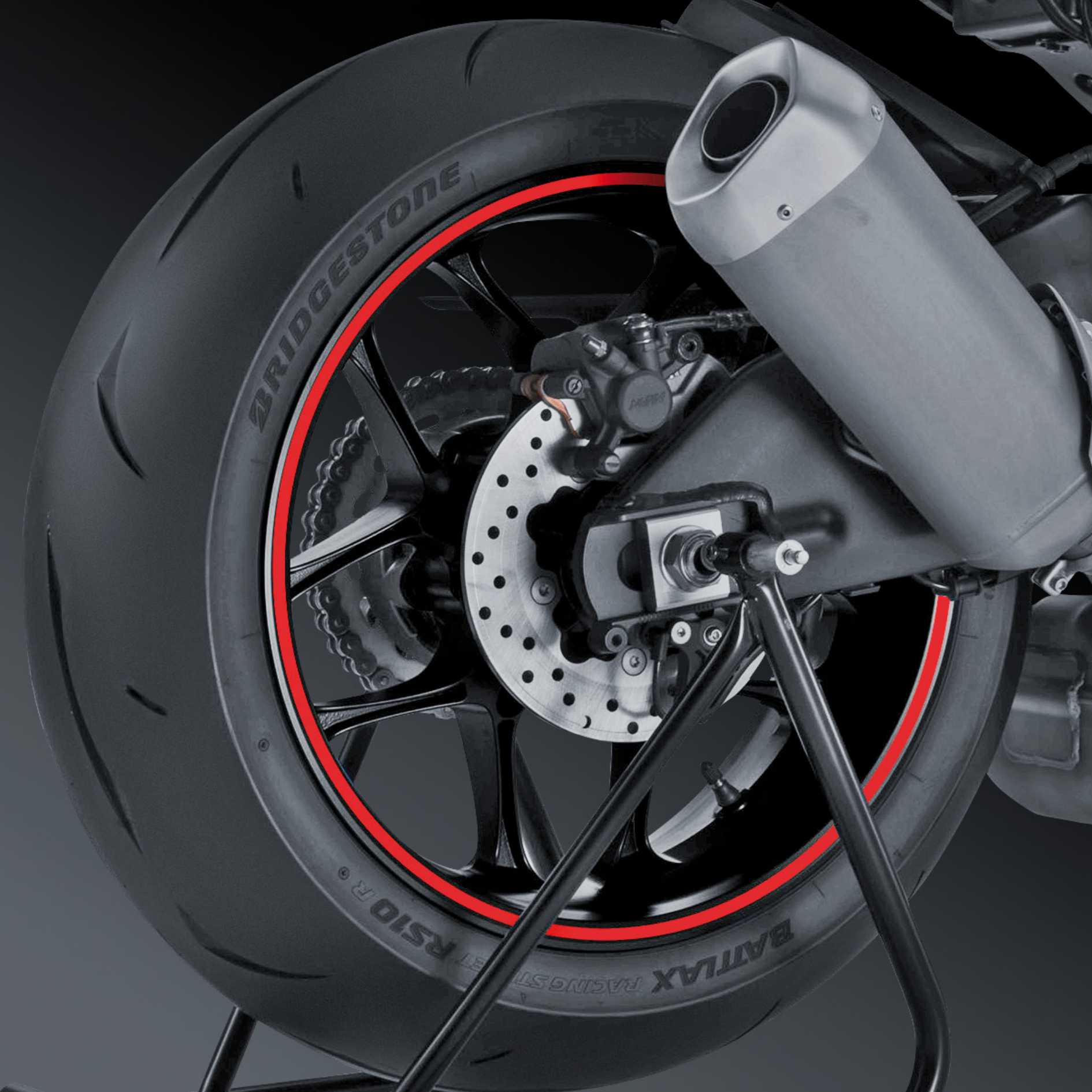



STRIP WITHOUT APLICATOR	PRICE
2568G	(*)
STRIP WITH APLICATOR	PRICE
4542G	(*)



STRIP WITHOUT APLICATOR	PRICE
2568O	(*)
STRIP WITH APLICATOR	PRICE
4542O	(*)



STRIP WITHOUT APLICATOR	PRICE
2568A	(*)
STRIP WITH APLICATOR	PRICE
4542A	(*)



STRIP WITHOUT APLICATOR	PRICE
2568B	(*)
STRIP WITH APLICATOR	PRICE
4542B	(*)



STRIP WITHOUT APLICATOR	PRICE
2568M	(*)
STRIP WITH APLICATOR	PRICE
4542M	(*)



STRIP WITHOUT APLICATOR	PRICE
2568C	(*)
STRIP WITH APLICATOR	PRICE
4542C	(*)



STRIP WITHOUT APLICATOR	PRICE
2568T	(*)
STRIP WITH APLICATOR	PRICE
4542T	(*)



STRIP WITHOUT APLICATOR	PRICE
2568X	(*)
STRIP WITH APLICATOR	PRICE
4542X	(*)



STRIP WITHOUT APLICATOR	PRICE
2568N	(*)
STRIP WITH APLICATOR	PRICE
4542N	(*)



STRIP WITHOUT APLICATOR	PRICE
2568Z	(*)
STRIP WITH APLICATOR	PRICE
4542Z	(*)



STRIP WITHOUT APLICATOR	PRICE
2568P	(*)
STRIP WITH APLICATOR	PRICE
4542P	(*)



STRIP WITHOUT APLICATOR	PRICE
2568Q	(*)
STRIP WITH APLICATOR	PRICE
4542Q	(*)



STRIP WITHOUT APLICATOR	PRICE
2568V	(*)
STRIP WITH APLICATOR	PRICE
4542V	(*)



STRIP WITHOUT APLICATOR	PRICE
2568L	(*)
STRIP WITH APLICATOR	PRICE
4542L	(*)



STRIP WITHOUT APLICATOR	PRICE
2568R	(*)
STRIP WITH APLICATOR	PRICE
4542R	(*)

STRIP SIZE
7 mm. WIDTH x 6 m. LENGTH.
TO BE APPLIED ON THE WHEEL
FROM 16" TO 18"





MODEL	REF.	PRICE
YELLOW FLUORESCENT	8431G	(*)



MODEL	REF.	PRICE
BLUE FLUORESCENT	8431A	(*)



MODEL	REF.	PRICE
WHITE FLUORESCENT	8431B	(*)



MODEL	REF.	PRICE
ORANGE FLUORESCENT	8431T	(*)



MODEL	REF.	PRICE
RED FLUORESCENT	8431R	(*)



MODEL	REF.	PRICE
GREEN FLUORESCENT	8431V	(*)



THE SET CONSISTS ON 8 RIM STRIPS. FOR 14" AND 21" RIMS.
MATERIAL: PVC LENTICULAR SEMI RIGID APPLIED ON RIMS OF 14" TO 21".
IMPORTANT: Indicate code color after part#. Example: 0973A.



SPECIAL RIM STRIPS

HI-TECH PARTS



THE SET CONSISTS ON 8 RIM STRIPS. FOR 14" AND 21" RIMS.
 MATERIAL: PVC LENTICULAR SEMI RIGID APPLIED ON RIMS OF 14" TO 21".

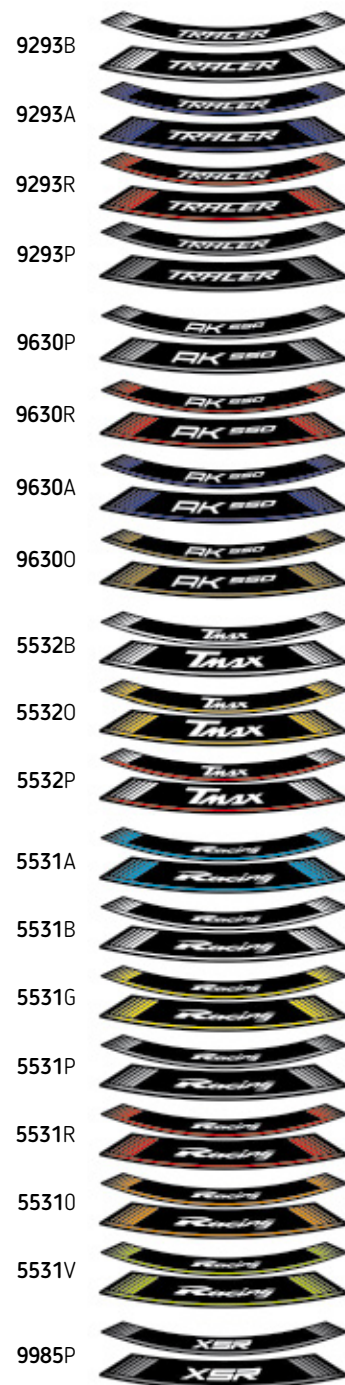
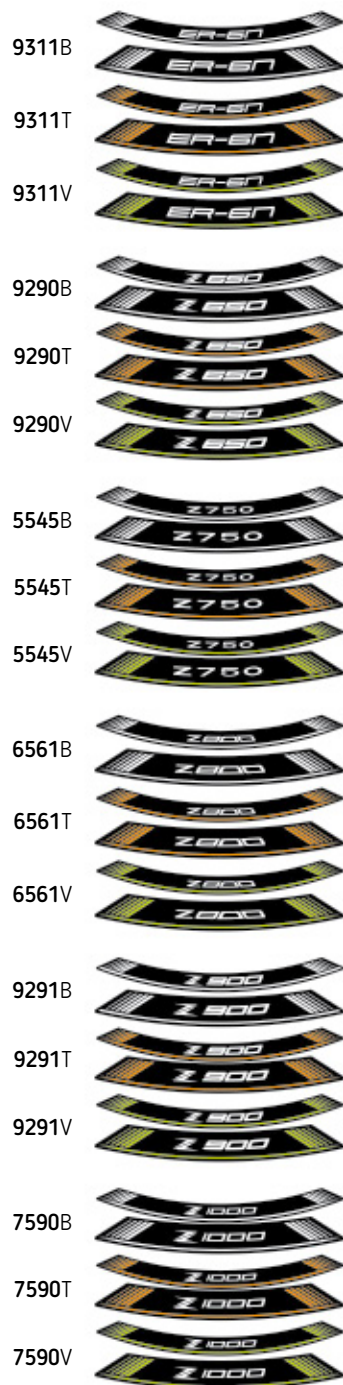
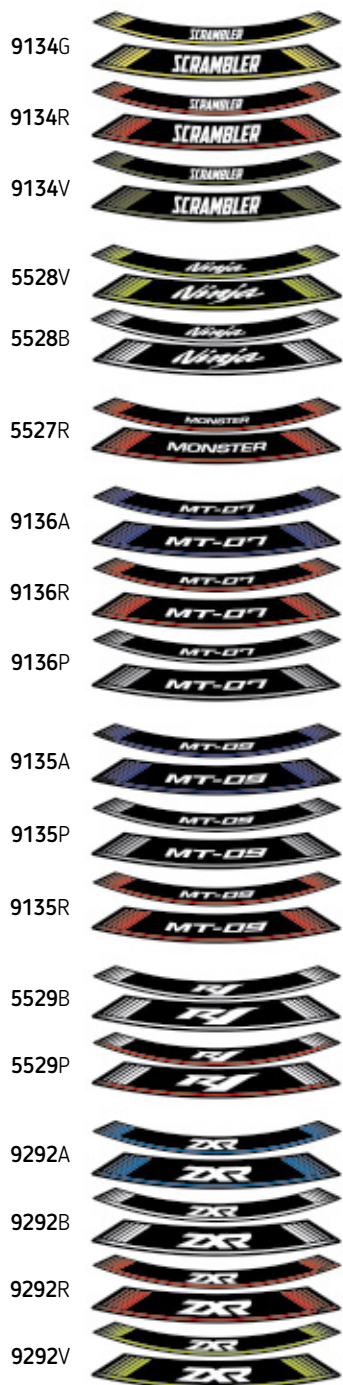

SPECIAL RIM STRIPS

HI-TECH PARTS

MODEL	YEAR	REF.	PRICE
BMW			
R NINE T	14' - 18'	9133	(*)
R NINE T SCRAMBLER	16' - 18'	9133	(*)
R NINE T PURE	17' - 18'	9133	(*)
R NINE T RACER	17' - 18'	9133	(*)
R NINE T URBAN G/S	17' - 18'	9133	(*)
DUCATI			
MONSTER 696	08' - 14'	5527	(*)
MONSTER 796	10' - 14'	5527	(*)
MONSTER 797	17' - 18'	5527	(*)
MONSTER 821	14' - 18'	5527	(*)
MONSTER 1100	09' - 10'	5527	(*)
MONSTER 1100 EVO	11' - 13'	5527	(*)
MONSTER 1200/S	14' - 18'	5527	(*)
MONSTER 1200 R	16' - 18'	5527	(*)
SCRAMBLER ICON/CLASSIC/FULL THROTTLE	15' - 18'	9134	(*)
SCRAMBLER SIXTY2	16' - 18'	9134	(*)
SCRAMBLER URBAN ENDURO	15' - 16'	9134	(*)
SCRAMBLER FLAT TRACK PRO	16'	9134	(*)
SCRAMBLER DESERT SLED	17' - 18'	9134	(*)
SCRAMBLER CAFE RACER	17' - 18'	9134	(*)
SCRAMBLER 1100	18'	9134	(*)
SCRAMBLER 1100 SPORT	18'	9134	(*)
SCRAMBLER 1100 SPECIAL	18'	9134	(*)
HONDA			
CB600F HORNET	98' - 16'	5526	(*)
CB900F HORNET	02' - 05'	5526	(*)
CBR250R	11' - 14'	5524	(*)
CBR500R	13' - 18'	5524	(*)
CBR600F	86' - 07'	5524	(*)
CBR600F	11' - 13'	5524	(*)
CBR650F	14' - 16'	5524	(*)
CBR650F	17' - 18'	5524	(*)
CBR600RR	03' - 06'	5524	(*)
CBR600RR	07' - 16'	5524	(*)

MODEL	YEAR	REF.	PRICE
CBR900RR FIRE BLADE	96' - 99'	5524	(*)
CBR900RR FIRE BLADE	00' - 01'	5524	(*)
CBR900RR FIRE BLADE	02' - 03'	5524	(*)
CBR1000RR FIREBLADE	04' - 07'	5524	(*)
CBR1000RR FIREBLADE	08' - 11'	5524	(*)
CBR1000RR FIREBLADE	12' - 16'	5524	(*)
CBR1000RR FIREBLADE/SP/SP2	17' - 18'	5524	(*)
SCOOPIY 80		5559	(*)
SCOOPIY SH50		5559	(*)
SCOOPIY SH100		5559	(*)
SCOOPIY SH125	02' - 06'	5559	(*)
SCOOPIY SH125i	07' - 08'	5559	(*)
SCOOPIY SH125i (rear brake disk)	09' - 10'	5559	(*)
SCOOPIY SH125i (rear brake disk)	11' - 12'	5559	(*)
SCOOPIY SH125i	13' - 16'	5559	(*)
SCOOPIY SH125i	17' - 18'	5559	(*)
SCOOPIY SH150	02' - 06'	5559	(*)
SCOOPIY SH150i	07' - 08'	5559	(*)
SCOOPIY SH150i (rear brake disk)	09' - 10'	5559	(*)
SCOOPIY SH150i (rear brake disk)	11' - 12'	5559	(*)
SCOOPIY SH150i	13' - 16'	5559	(*)
SCOOPIY SH150i	17' - 18'	5559	(*)
SCOOPIY SH300i	07' - 10'	5559	(*)
SCOOPIY SH300i	11' - 14'	5559	(*)
SCOOPIY SH300i	15' - 17'	5559	(*)
KAWASAKI			
ER-6F	06' - 16'	9311	(*)
ER-6N	06' - 16'	9311	(*)
NINJA H2	15' - 18'	5528	(*)
NINJA 250R	08' - 12'	5528	(*)
NINJA 250SL	15' - 16'	5528	(*)
NINJA 300	13' - 17'	5528	(*)
NINJA 400	18'	5528	(*)
NINJA 650	17' - 18'	5528	(*)
Z650	17' - 18'	9290	(*)

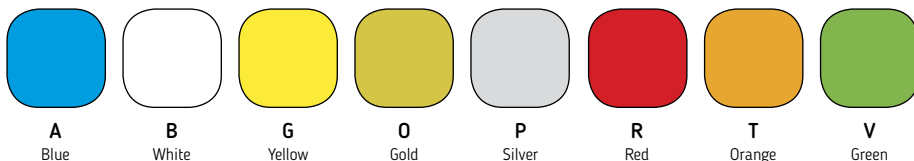

(*) Check price with your distributor.

IMPORTANT: Indicate code color after part#. Example: 0973A.

MODEL	YEAR	REF.	PRICE
Z900	17' - 18'	9291	(*)
Z900RS	18'	9291	(*)
Z750	04' - 06'	5545	(*)
Z750	07' - 12'	5545	(*)
Z750R	11' - 12'	5545	(*)
Z800	13' - 16'	6561	(*)
Z800E	13' - 16'	6561	(*)
Z1000	03' - 16'	7590	(*)
Z1000/R	17' - 18'	7590	(*)
Z1000SX	11' - 18'	7590	(*)
ZX-6R	94' - 16'	9292	(*)
ZX-6R	00' - 04'	9292	(*)
ZX-6R	05' - 06'	9292	(*)
ZX-6R	07' - 16'	9292	(*)
ZX-6R 636	13' - 16'	9292	(*)
ZX-9R	98' - 04'	9292	(*)
ZX-9R	00' - 04'	9292	(*)
ZX-10R	04' - 18'	9292	(*)
ZX-10RR	17' - 18'	9292	(*)
ZX-10R SE	18'	9292	(*)
ZX-12R	00' - 06'	9292	(*)
KYMCO			
AK550	17' - 18'	9630	(*)
SUZUKI			
GSR600	06' - 11'	5989	(*)
GSR750	11' - 16'	5989	(*)
GSX-R125	17' - 18'	5525	(*)
GSX-R250	17' - 18'	5525	(*)
GSX-R600	96' - 17'	5525	(*)
GSX-R750	96' - 17'	5525	(*)
GSX-R1000	01' - 16'	5525	(*)
GSX-R1000/R	17' - 18'	5525	(*)
GSX-R1300 HAYABUSA	99' - 07'	5525	(*)
GSX-S125	17' - 18'	9442	(*)
GSX-S750	17' -18'	9442	(*)

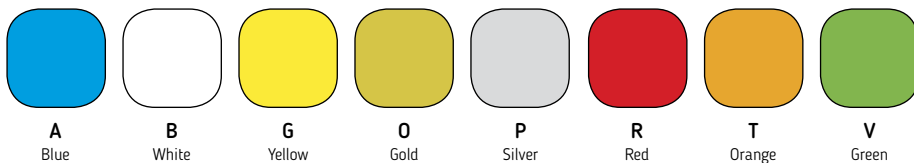

MODEL	YEAR	REF.	PRICE
GSX-S1000	15' - 18'	9442	(*)
GSX-S1000F	15' - 18'	9442	(*)
YAMAHA			
MT-09	13' - 16'	9135	(*)
MT-09	17' - 18'	9135	(*)
MT-09 SP	18'	9135	(*)
MT-09 TRACER	15' - 18'	9135	(*)
MT-09 TRACER GT	18'	9135	(*)
MT-07	14' - 18'	9136	(*)
MT-07 TRACER	16' - 18'	9136	(*)
MT-07 TRACER	16' - 18'	9293	(*)
MT-09 TRACER	15' - 18'	9293	(*)
MT-09 TRACER GT	18'	9293	(*)
XSR700	16' - 18'	9985	(*)
XSR900	16' - 18'	9985	(*)
YZF-R1	99' - 18'	5529	(*)
YZF-R1M	17' - 18'	5529	(*)
YZF-R6	99' - 18'	5530	(*)
T-MAX 500	08' - 11'	5532	(*)
T-MAX 530	12' - 16	5532	(*)
T-MAX 530/DX/SX	17' - 18'	5532	(*)
UNIVERSAL			
RACING		5531	(*)

(*) Check price with your distributor.

IMPORTANT: Indicate code color after part#. Example: 0973A.



RIM STRIPS GS

HI-TECH PARTS | TECHNICAL SECTION



MODEL	YEAR	REF.	O N
R1200GS	13' - 18'	20150	(*)
R1200GS EXCLUSIVE	17' - 18'	20150	(*)
R1200GS RALLYE	17' - 18'	20150	(*)
R1200GS ADVENTURE	14' - 18'	20151	(*)
R1250GS	18'	20150	(*)
R1250GS ADVENTURE	18'	20151	(*)

20150N



20151N



201500



201510



SWING ARM PROTECTOR GS

HI-TECH PARTS | TECHNICAL SECTION



MODEL	YEAR	REF.	O N B
BMW			
R1200GS	04' - 12'	20152	(*)
R1200GS	13' - 18'	20153	(*)
R1200GS EXCLUSIVE	17' - 18'	20153	(*)
R1200GS RALLYE	17' - 18'	20153	(*)
R1200GS ADVENTURE	06' - 13'	20152	(*)
R1200GS ADVENTURE	14' - 18'	20153	(*)
R1250GS	18'	20153	(*)
R1250GS ADVENTURE	18'	20153	(*)

20153B



20152B



20153N



20152N



201530



201520





SUPER TOURING

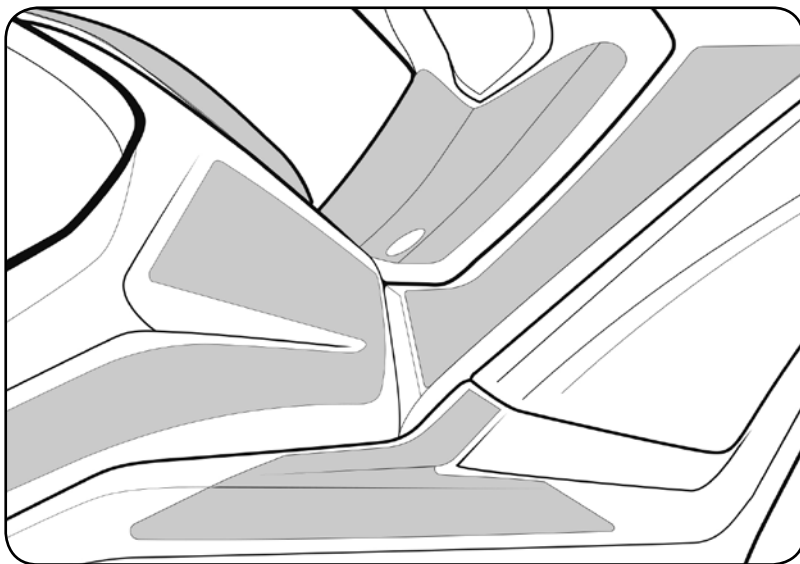

// SPECIFIC DESIGN FOR EACH MODEL OF MAXISCOOTER

Protects from scratches of getting on/off the bike, as well as embellishes the plastic without altering the graphics of the Maxiscooter.

MODEL	YEAR	REF.	N
BMW			
C650 SPORT	16' - 18'	9951	(*)
HONDA			
X-ADV	17' - 18'	9952	(*)
KYMCO			
AK550	17' - 18'	9953	(*)
YAMAHA			
T-MAX 530/SX/DX	17' - 18'	9954	(*)



N
Black

KYMCO AK550
TANKPAD SCOOTER SCRATCH SAVER

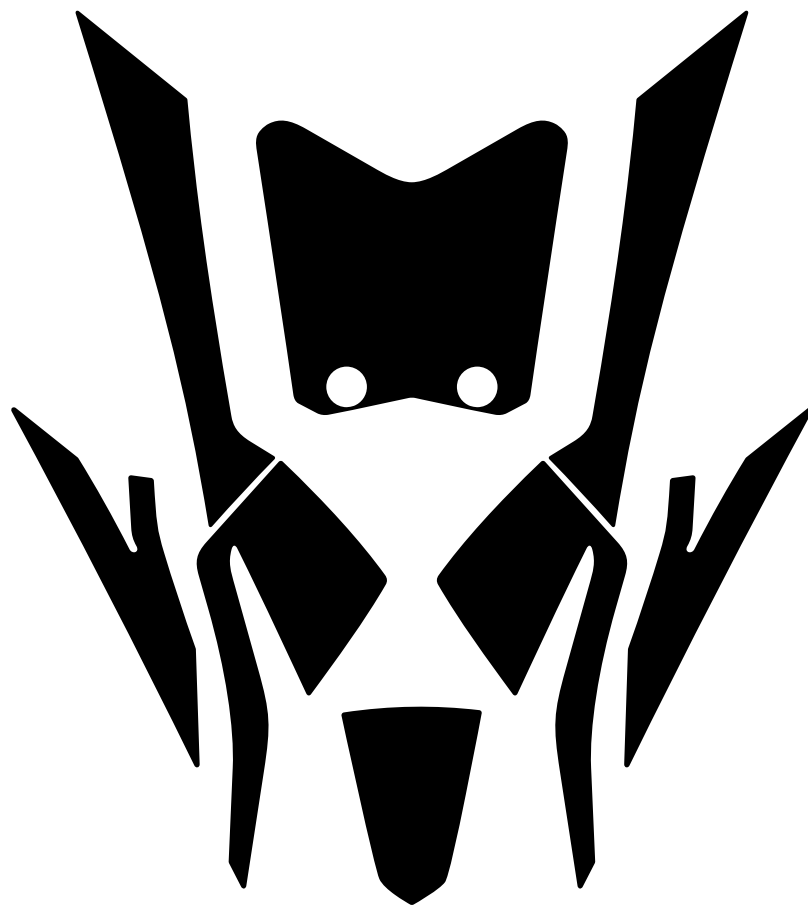

(*) Check price with your distributor.

IMPORTANT: Indicate code color after part#. Example: 0973A.



MODEL	YEAR	REF.	C
BMW			
R NINE T	14' - 18'	9129C	(*)
R NINE T SCRAMBLER	16' - 18'	9129C	(*)
R NINE T PURE	17' - 18'	9129C	(*)
R NINE T RACER	17' - 18'	9129C	(*)
R NINE T URBAN G/S	17' - 18'	9129C	(*)
S1000R	14' - 18'	9130C	(*)
F800R	09' - 18'	8433C	(*)
R1200GS	13 - 16'	8434C	(*)
R1200GS	17' - 18'	9463C	(*)
R1200GS EXCLUSIVE	17' - 18'	9463C	(*)
R1200GS RALLYE	17' - 18'	9463C	(*)
DUCATI			
SCRAMBLER ICON/CLASSIC/FULL THROTTLE	15' - 18'	9131C	(*)
SCRAMBLER SIXTY2	16' - 18'	9131C	(*)
SCRAMBLER URBAN ENDURO	15' - 16'	9131C	(*)
SCRAMBLER FLAT TRACK PRO	16'	9131C	(*)
SCRAMBLER DESERT SLED	17' - 18'	9131C	(*)
SCRAMBLER CAFE RACER	17' - 18'	9131C	(*)
HONDA			
CRF1000L AFRICA TWIN	16' - 18'	9303C	(*)
KAWASAKI			
ER-6N	12' - 16'	9132C	(*)
Z650	17' - 18'	9297C	(*)
Z800/E	13' - 16'	8435C	(*)
Z900	17' - 18'	9296C	(*)
Z1000	14' - 18'	8436C	(*)
KTM			
1290 SUPERDUKE R	14' - 18'	9298C	(*)
SUZUKI			
GSR750	11' - 16'	8437C	(*)
GSX-S750	17' - 18'	9295C	(*)
YAMAHA			
MT-07	14' - 18'	8438C	(*)
MT-07 TRACER	16' - 18'	9301C	(*)
XSR700	16' - 18'	9300C	(*)
MT-09	13' - 16'	8439C	(*)
MT-09	17' - 18'	8439C	(*)
MT-09 TRACER	15' - 18'	9302C	(*)
XSR900	16' - 18'	9299C	(*)
MT-10	16' - 18'	9294C	(*)
MT-10 SP	17' - 18'	9294C	(*)

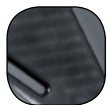

C

Carbon Look combined with transparent

// DESIGNED SPECIALLY FOR EACH MOTORCYCLE

The kit consists on three elements: Frontal protection and two side protections which improve grip on curves.

8439C

TANKPAD X-TREME
YAMAHA MT-09

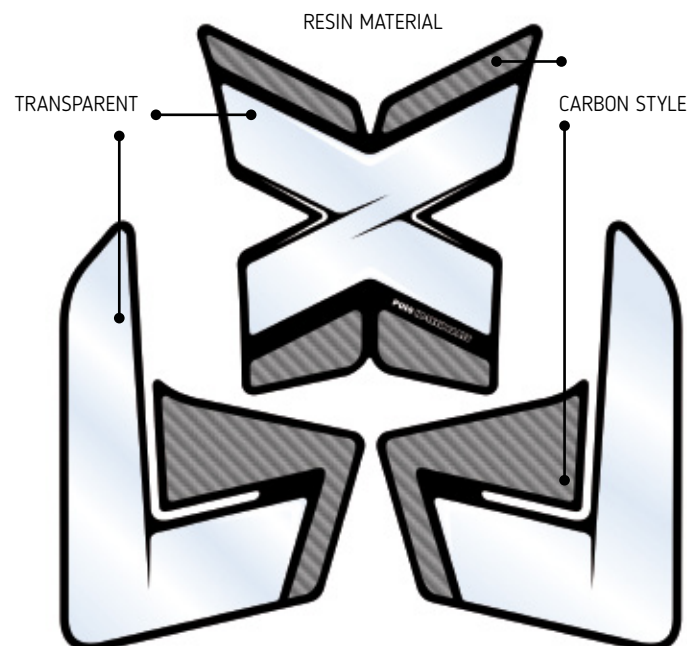

(*) Check price with your distributor.

IMPORTANT: Indicate code color after part#. Example: 0973A.



ONEDESIGN

TD

MODEL	YEAR	REF.	PRICE
APRILIA			
RSV4	09' - 12'	20060N	(*)
RSV4 FACTORY	09' - 15'	20060N	(*)
RSV4 R	13' - 14'	20060N	(*)
RSV4 RF/RR	15' - 18'	20060N	(*)
TUONO V4R	11' - 14'	20060N	(*)
TUONO V4 1100 RR	15' - 18'	20060N	(*)
TUONO V4 1100 FACTORY	15' - 18'	20060N	(*)
BMW			
R1200 GS	04' - 12'	20061N	(*)
R1200 GS	13' - 18'	20062N	(*)
R1200 GS RALLYE	17' - 18'	20062N	(*)
R1200 GS EXCLUSIVE	17' - 18'	20062N	(*)
R1200 GS ADVENTURE	06' - 13'	20061N	(*)
R1200GS ADVENTURE	14' - 18'	20063N	(*)
R1200 RS	14' - 18'	20063N	(*)
R1200 RS	14' - 18'	20064N	(*)
S1000 R	09' - 18'	20065N	(*)
S1000 RR	09' - 18'	20065N	(*)
DUCATI			
899 PANIGALE	14' - 15'	20066N	(*)
959 PANIGALE	16' - 18'	20066N	(*)
1199 PANIGALE	12' - 14'	20066N	(*)
1299 PANIGALE/S	15' - 17'	20066N	(*)
PANIGALE V4	18'	20067N	(*)
PANIGALE V4 S	18'	20067N	(*)
PANIGALE V4 SPECIALE	18'	20067N	(*)
MONSTER 821	14' - 18'	20068N	(*)
MONSTER 1200/S	14' - 18'	20068N	(*)
MONSTER 1200/S	14' - 18'	20068N	(*)
MONSTER 1200 R	14' - 18'	20068N	(*)
MULTISTRADA 950	15' - 18'	20069N	(*)
MULTISTRADA 1200/ S	15' - 18'	20069N	(*)
MULTISTRADA 1200/S	15' - 18'	20069N	(*)
MULTISTRADA 1200 ENDURO/PRO	16' - 18'	20070N	(*)
MULTISTRADA 1200 PIKES PEAK	15' - 18'	20069N	(*)
MULTISTRADA 1260/S/S DJAIR	15' - 18'	20069N	(*)
MULTISTRADA 1260 PIKES PEAK	15' - 18'	20069N	(*)
SCRAMBLER ICON/CLASSIC/FULL THROTTLE	15' - 18'	20071N	(*)
SCRAMBLER SIXTY2	15' - 18'	20071N	(*)
SCRAMBLER URBAN ENDURO	15' - 18'	20071N	(*)
SCRAMBLER FLAT TRACK PRO	15' - 18'	20071N	(*)
SCRAMBLER DESERT SLED	15' - 18'	20071N	(*)
SCRAMBLER CAFE RACER	15' - 18'	20071N	(*)
SCRAMBLER 1100	15' - 18'	20071N	(*)

MODEL	YEAR	REF.	PRICE
SCRAMBLER 1100 SPORT	15' - 18'	20071N	(*)
SCRAMBLER 1100 SPECIAL	15' - 18'	20071N	(*)
HONDA			
CBR600RR	13' - 16'	20072N	(*)
CBR1000RR FIREBLADE/SP	12' - 16'	20073N	(*)
CBR1000RR FIREBLADE/SP/SP2	17' - 18'	20074N	(*)
CRF1000L AFRICA TWIN	16' - 18'	20075N	(*)
CRF1000L AFRICA TWIN ADVENTURE SPORTS	18'	20075N	(*)
KAWASAKI			
NINJA 400	18'	20076N	(*)
VERSYS 1000	15' - 18'	20077N	(*)
Z900	17' - 18'	20078N	(*)
Z1000SX	11' - 18'	20079N	(*)
ZX-6R	09' - 16'	20080N	(*)
ZX-6R 636	09' - 16'	20080N	(*)
ZX-10R	11' - 18'	20081N	(*)
SUZUKI			
DL1000 V-STROM	14' - 18'	20082N	(*)
DL1000XT V-STROM	17' - 18'	20082N	(*)
GSX-R600	11' - 16'	20083N	(*)
GSX-R750	11' - 16'	20083N	(*)
GSX-R1000/R	17' - 18'	20084N	(*)
GSX-S750	17' - 18'	20085N	(*)
GSX-S1000	15' - 18'	20086N	(*)
GSX-S1000F	16' - 18'	20086N	(*)
TRIUMPH			
DAYTONA 675	13' - 17'	20087N	(*)
DAYTONA 675 R	13' - 17'	20087N	(*)
STREET TRIPLE	13' - 18'	20087N	(*)
STREET TRIPLE R	13' - 18'	20087N	(*)
STREET TRIPLE S/RS	17' - 18'	20087N	(*)
TIGER 800 XR/XRX/XRT	16' - 18'	20088N	(*)
YAMAHA			
MT-07	18'	20089N	(*)
MT-09	13' - 18'	20090N	(*)
MT-09 SP	18'	20090N	(*)
MT-09 TRACER	15' - 18'	20091N	(*)
MT-09 TRACER GT	15' - 18'	20091N	(*)
MT-10	16' - 18'	20092N	(*)
MT-10 SP	17' - 18'	20092N	(*)
XT1200Z SUPER TÉNÉRÉ	12' - 18'	20093N	(*)
YZF-R1	15' - 18'	20094N	(*)
YZF-R1M	17' - 18'	20094N	(*)
YZF-R6	08' - 16'	20095N	(*)
YZF-R6	17' - 18'	20096N	(*)



EASY MOUNTING PROCESS



ANTI-SCRATCH



IMPROVE GRIP



SOFT RUBBER FEEL

(*) Check price with your distributor.

IMPORTANT: Indicate code color after part#. Example: 0973A.





// TANK PAD

MODEL	REF.	U
UNIVERSAL	6291U	(*)



// FUEL CAP COVER

MODEL	PAGE	U
SPECIFIC MODELS	372	(*)



// YOKE PROTECTOR

MODEL	PAGE	U
SPECIFIC MODELS	374	(*)



NAKED FUEL CAP COVER

HI-TECH PARTS

2019
MODELS:
www.puig.tv

MODEL	YEAR	REFERENCE	U
APRILIA			
ALL	TO 07'	6293	(*)
ALL	08' - 18'	6295	(*)
SHIVER 900	17' - 18'	6293	(*)
BMW			
G310 GS	17' - 18'	8968	(*)
G310 R	16' - 18'	8968	(*)
R1200 R	15' - 18'	6824	(*)
R1200 RS	15' - 18'	6824	(*)
R1200GS	13' - 16'	6824	(*)
R1200GS	17' - 18'	6299	(*)
R1200GS EXCLUSIVE	17' - 18'	6299	(*)
R1200GS RALLYE	17' - 18'	6299	(*)
S1000 RR	15' - 16'	6299	(*)
S1000 XR	15' - 18'	6824	(*)
R NINE T URBAN G/S	17' - 18'	6299	(*)
R NINE T PURE	17' - 18'	6299	(*)
R NINE T RACER	17' - 18'	6299	(*)
ALL	TO 06'	6297	(*)
ALL	07' - 18'	6299	(*)
CAGIVA			
ALL		6293	(*)
DUCATI			
X DIAVEL	16' - 18'	6305	(*)
959 PANIGALE	16' - 18'	6305	(*)
PANIGALE V4	18'	6305	(*)
PANIGALE V4S	18'	6305	(*)
PANIGALE V4 SPECIALE	18'	6305	(*)
MULTISTRADA 950	17' - 18'	8236	(*)
MULTISTRADA 1200/S	15' - 17'	8236	(*)
MULTISTRADA 1200 PIKES PEAK	16' - 17'	8236	(*)
MULTISTRADA 1260/S/S DJAIR	18'	8236	(*)
MULTISTRADA 1260 PIKES PEAK	18'	8236	(*)
MONSTER 797	17' - 18'	6303	(*)
MONSTER 821	14' - 18'	6303	(*)
MONSTER 1200/S	14' - 16'	6303	(*)
MONSTER 1200/S	17' - 18'	6303	(*)
MONSTER 1200 R	16' - 18'	6303	(*)
SUPERSPORT 939/S	17' - 18'	6303	(*)
ALL	TO 08'	6303	(*)
ALL (1)	09' - 18'	6305	(*)
(1) EXCEPT: SCRAMBLER, HYPERSTRADA			(*)

MODEL	YEAR	REFERENCE	U
HONDA			
CB125R NEO SPORTS CAFE	18'	7571	(*)
CB500F	16'	7571	(*)
CB500X	16'	7571	(*)
CBR500R	16'	7571	(*)
CMX500 REBEL	17' - 18'	7571	(*)
CROSSRUNNER	15' - 16'	7571	(*)
CB650F	17' - 18'	7571	(*)
CBR650F	17' - 18'	7571	(*)
CBR1000RR FIREBLADE/SP/SP2	17' - 18'	7571	(*)
ALL	TO 13'	6307	(*)
ALL	14' - 18'	7571	(*)
KAWASAKI			
NINJA 250R	08' - 12'	6313	(*)
NINJA 250SL	15' - 16'	8242	(*)
NINJA 300	13' - 18'	6313	(*)
NINJA 400	18'	9361	(*)
NINJA 650	17' - 18'	9361	(*)
NINJA H2 SX	18'	8976	(*)
VERSYS-X 300	17' - 18'	9361	(*)
VERSYS 650	15' - 18'	6311	(*)
VERSYS 1000	15' - 18'	6311	(*)
VULCAN S	15' - 18'	6311	(*)
VULCAN S CAFE	17' - 18'	6311	(*)
Z125	17' - 18'	6311	(*)
Z250SL	15' - 16'	8242	(*)
Z300	15' - 17'	8242	(*)
Z650	17' - 18'	9361	(*)
Z900	17' - 18'	9361	(*)
Z900RS	18'	8976	(*)
Z1000SX	17' - 18'	6311	(*)
ZX-10R	16' - 18'	8976	(*)
ZX-10RR	17' - 18'	8976	(*)
ALL	00' - 05'	6309	(*)
ALL	06' - 18'	6311	(*)
KTM			
125 DUKE	11' - 16'	7610	(*)
125 DUKE	17' - 18'	7610	(*)
390 DUKE	13' - 16'	7610	(*)
390 DUKE	17' - 18'	7610	(*)
690 DUKE	16' - 18'	8978	(*)
690 DUKE R	16' - 17'	8978	(*)

MODEL	YEAR	REFERENCE	U
790 DUKE	18'	7610	(*)
1050 ADVENTURE	15' - 16'	8172	(*)
1190 ADVENTURE/R	13' - 16'	8172	(*)
1090 ADVENTURE/R	17' - 18'	8172	(*)
1290 SUPERDUKE R	17' - 18'	9446	(*)
1290 SUPER ADVENTURE	15' - 16'	8172	(*)
1290 SUPER ADVENTURE R	17' - 18'	9446	(*)
1290 SUPER ADVENTURE S	17' - 18'	9446	(*)
1290 SUPER ADVENTURE T	17'	9446	(*)
1290 SUPERDUKE GT	16' - 17'	8172	(*)
RC125/RC390	14' - 18'	7610	(*)
SUZUKI			
DL250 V-STROM	17' - 18'	6317	(*)
DL650 V-STROM	17' - 18'	9428	(*)
DL650XT V-STROM	17' - 18'	9428	(*)
DL1000 V-STROM	17' - 18'	9428	(*)
DL1000XT V-STROM	17' - 18'	9428	(*)
GSX-S125	17' - 18'	9964	(*)
GSX-S750	17' - 18'	9428	(*)
GSX-S1000	15' - 16'	6317	(*)
GSX-S1000F	15' - 16'	6317	(*)
GSX-R125	17' - 18'	9608	(*)
GSX-R250	17' - 18'	6317	(*)
GSX-R1000	15' - 16'	6317	(*)
GSX-R1000/R	17' - 18'	9428	(*)

MODEL	YEAR	REFERENCE	U
INAZUMA F	15' - 16'	6317	(*)
SV650	16'	6317	(*)
SV650X	18'	9428	(*)
ALL	96' - 02'	6315	(*)
ALL	03' - 18'	6317	(*)
TRIUMPH			
SPEED TRIPLE/R	16' - 18'	8980	(*)
STREET TRIPLE/R/S/RS	17' - 18'	8980	(*)
TIGER EXPLORER XC/XR/XRX/XRT/XCX/XCA	16' - 18'	8980	(*)
ALL		6293	(*)
YAMAHA			
MT-125	15' - 18'	7583	(*)
MT-10	16' - 18'	6323	(*)
MT-07	14' - 18'	6323	(*)
MT-09	17' - 18'	6323	(*)
MT-09 SP	18'	6323	(*)
XSR700	16' - 18'	6323	(*)
XSR900	16' - 18'	6323	(*)
YZF-R125	14' - 18'	7583	(*)
YZF-R1	15' - 16'	6323	(*)
YZF-R3	15' - 18'	8254	(*)
YZF-R6	17' - 18'	6323	(*)
ALL	TO 99'	6321	(*)
ALL	00' - 18'	6323	(*)

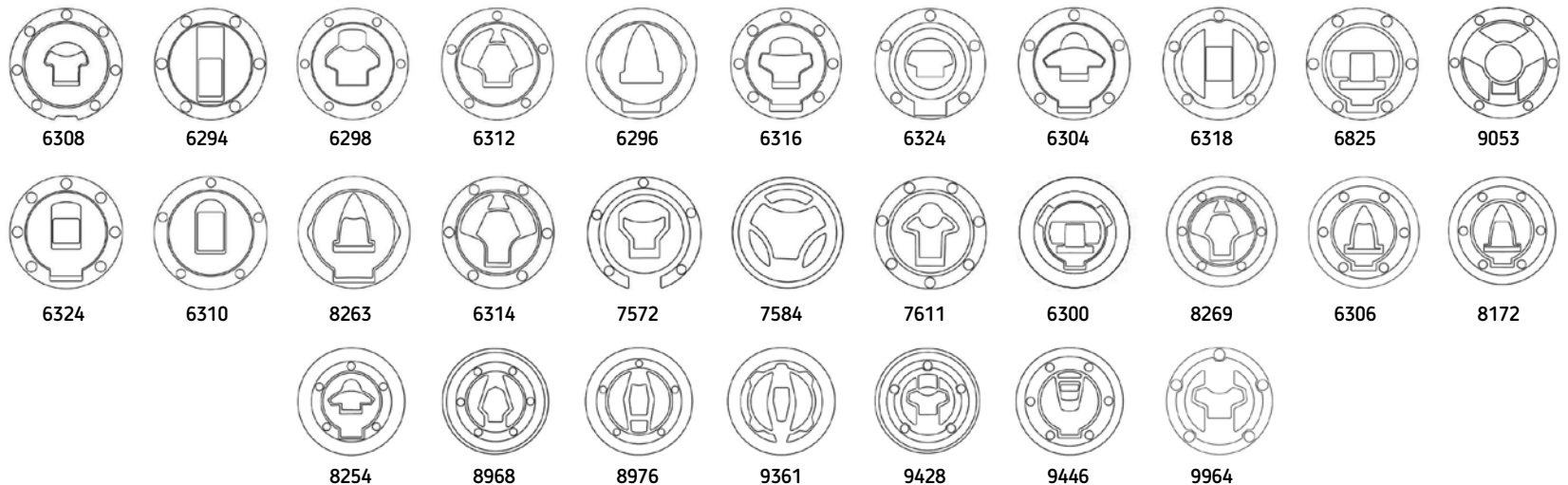

IMPORTANT: We recommend verify the design of the cap with the above diagrams when ordering.

MODEL	YEAR	REFERENCE YOKE	REFERENCE KEY CONTACT	U
APRILIA				
RSV4	09' - 12'	7457		(*)
RSV4 FACTORY	13' - 14'	7457		(*)
RSV4 R	13' - 14'	9171		(*)
SHIVER 750	07' - 16'	7456		(*)
BMW				
F800 GS	08' - 17'	7454		(*)
F800 S	06' - 11'	7454		(*)
K1200 R SPORT	07' - 08'	7452		(*)
R1100 GS	94' - 99'	7451		(*)
R1150 GS	99' - 04'	7451		(*)
R1150 RS	01' - 05'	7455		(*)
R1200 GS	08' - 12'	7453		(*)
R NINE T	14' - 18'	7460		(*)
S1000 RR	09' - 14'	7450		(*)
S1000 RR	15' - 18'	8289		(*)
S1000 XR	15' - 18'	8290		(*)
DUCATI				
749/749S/999/999S	03' - 04'	7449		(*)
899 PANIGALE	14' - 15'	7459		(*)
959 PANIGALE	16' - 18'	7459		(*)
959 PANIGALE CORSE	18'	7459		(*)
1299 PANIGALE/S	15' - 17'	7459		(*)
DIAVEL	11' - 18'	7448		(*)
MONSTER 620	02' - 06'	7447		(*)
MONSTER 695	06' - 07'	7447		(*)
MONSTER 696	08' - 14'	7447		(*)
MONSTER 796	10' - 14'	7447		(*)
MONSTER 800	03' - 04'	7447		(*)
MONSTER 1000	02' - 05'	7447		(*)
MONSTER 1100	09' - 10'	7447		(*)
MONSTER 1100 EVO	11' - 13'	7447		(*)
MULTISTRADA 1200/S	10' - 14'	7446		(*)
HONDA				
CB600F HORNET	03' - 06'	7437		(*)
CB1100	13' - 14'	7372		(*)
CBR650F	14' - 18'	7463		(*)
CBR125R	11' - 18'	7445		(*)
CBR250R	11' - 14'	7444		(*)
CBR500R	13' - 15'	7374		(*)
CBR500R	16' - 18'	8989		(*)



MODEL	YEAR	REFERENCE YOKE	REFERENCE KEY CONTACT	U
CBR600RR	90' - 94'	7442		(*)
CBR600RR	95' - 98'	7443		(*)
CBR600RR	99' - 02'	7441		(*)
CBR600RR	03' - 04'	7440		(*)
CBR600RR	05' - 06'	7439		(*)
CBR600RR	07' - 16'	7438		(*)
CBR900RR FIRE BLADE	98' - 99'	7436		(*)
CBR900RR FIRE BLADE	00' - 01'	7435		(*)
CBR900RR FIRE BLADE	02' - 03'	7435		(*)
CBR1000RR FIRE BLADE	04' - 07'	7434		(*)
CBR1000RR FIRE BLADE	08' - 13'	7433		(*)
CBR1000RR FIRE BLADE/SP	14' - 16'	7433		(*)
CBR1100XX BLACKBIRD	97' - 07'	7432		(*)
CROSSRUNNER	11' - 14'	7431		(*)
CRF1000L AFRICA TWIN	16' - 18'	8990		(*)
NC700S/X	12' - 13'	7430		(*)
NC750X	14' - 15'	7430		(*)
VFR800	98' - 01'	7498		(*)
VFR800	02' - 13'	7429		(*)
VFR800F	14' - 18'	7468		(*)
VFR1200F	10' - 16'	7428		(*)
KAWASAKI				
ER-6F	09' - 11'	7422		(*)
ER-6F	12' - 16'	7421		(*)
ER-6N	05' - 08'	7423		(*)
ER-6N	09' - 11'	7422		(*)
ER-6N	12' - 16'	7421		(*)
NINJA 250SL	15' - 16'	8294		(*)
NINJA 250R	08' - 12'	7420		(*)
NINJA 300	13' - 17'	7373		(*)
NINJA 400	18'	9625		(*)
NINJA 650	17' - 18'	9364		(*)
Z650	17' - 18'	9364		(*)
Z750	07' - 12'	7418		(*)
Z750R	11' - 12'	7418		(*)
Z750S	05' - 06'	7418		(*)
Z800/E	13' - 16'	7371		(*)
Z1000	03' - 06'	7418		(*)
Z1000	07' - 09'	7418		(*)
Z1000	10' - 13'	7419		(*)
Z1000	14' - 18'		7469	(*)

MODEL	YEAR	REFERENCE YOKE	REFERENCE KEY CONTACT	U
Z1000SX	11' - 13'	7416		(*)
Z1000SX	14' - 16'	7416		(*)
Z1000SX	17' - 18'		9403	(*)
ZX-6R	03' - 04'	7411		(*)
ZX-6R	05' - 06'	7417		(*)
ZX-6R	07' - 08'	7415		(*)
ZX-6R	09' - 16'	7414		(*)
ZX-10R	06' - 10'	7413		(*)
ZX-10R	11' - 15'	7410		(*)
ZZR1400	06' - 15'	7409		(*)
KTM				
125 DUKE	17' - 18'	9489		(*)
390 DUKE	13' - 16'	9489		(*)
690 DUKE	16' - 18'	8993		(*)
690 DUKE R	16' - 17'	8993		(*)
RC125/RC390	14' - 18'	7679		(*)
MV AGUSTA				
F3 800	13' - 18'	7368		(*)
SUZUKI				
DL650 V-STROM	04' - 11'	7388		(*)
DL650 V-STROM	12' - 16'	7387		(*)
DL650XT V-STROM	15' - 16'	7387		(*)
DL1000 V-STROM	02' - 07'	7388		(*)
GSF650S BANDIT	07' - 14'	7412		(*)
GSF1250 BANDIT	07' - 11'	7389		(*)
GSF1250S BANDIT	07' - 11'	7389		(*)
GSR600	06' - 11'	7408	7472	(*)
GSR750	11' - 16'	7385	7473	(*)
GSX650F	08' - 17'	7384		(*)
GSX-S750	17' - 18'	9431		(*)
GSX-S1000	15' - 18'	8301		(*)
GSX-S1000F	15' - 18'	8301		(*)
GSX-R250	17' - 18'	9527		(*)
GSX-R600	01' - 03'	7383		(*)
GSX-R600	04' - 05'	7406		(*)
GSX-R600	06' - 16'	7404		(*)
GSX-R750	04' - 05'	7407		(*)
GSX-R750	06' - 16'	7404		(*)
GSX-R1000	01' - 02'	7403		(*)
GSX-R1000	03' - 04'	7405		(*)
GSX-R1000	05' - 06'	7402		(*)

MODEL	YEAR	REFERENCE YOKE	REFERENCE KEY CONTACT	U
GSX-R1000	07' - 08'	7401		(*)
GSX-R1000	09' - 16'	7382		(*)
GSX-R1000/R	17' - 18'	9458		(*)
GSX-R1300 HAYABUSA	08' - 17'	7381		(*)
INAZUMA	13' - 17'	7475		(*)
SFV650 GLADIUS	09' - 15'	7386		(*)
SV650S	99' - 02'	7380		(*)
SV650S	03' - 08'	7400		(*)
SV650	16' - 18'	8994		(*)
SV650X	18'	9659		(*)
SV1000S	03' - 05'	7399		(*)
TRIUMPH				
DAYTONA 675	13' - 17'	7369		(*)
DAYTONA 675 R	13' - 17'	7369		(*)
YAMAHA				
FAZER8	13' - 16'	7393		(*)
FZ1	06' - 15'	7398		(*)
FZ1 FAZER	06' - 15'	7398		(*)
FZ6	04' - 08'	7378		(*)
FZ6 FAZER	04' - 08'	7378		(*)
FZ6 S2	09' - 10'	7397		(*)
FZ6 FAZER S2	07' - 10'	7397		(*)
FZ8	10' - 16'	7393		(*)
FZ8 FAZER	10' - 12'	7393		(*)
MT-03	06' - 13'		7474	(*)
XJ6	09' - 16'	7377		(*)
XJ6 DIVERSION	09' - 16'	7377		(*)
XJ6 DIVERSION F	10' - 16'	7377		(*)
YZF-R125	14' - 18'	7585		(*)
YZF-R1	02' - 03'	7392		(*)
YZF-R1	04' - 06'	7391		(*)
YZF-R1	07' - 08'	7394		(*)
YZF-R1	09' - 11'	7375		(*)
YZF-R1	12' - 14'	7390		(*)
YZF-R3	15' - 18'	8307		(*)
YZF-R6	99' - 02'	7376		(*)
YZF-R6	03' - 04'	7476		(*)
YZF-R6	05'	7396		(*)
YZF-R6	06' - 16'	7395		(*)
YZF-R6	17' - 18'	9844		(*)





// TANK PAD

MODEL	REF.	R	V	A	U
UNIVERSAL	6292				(*)



// FUEL CAP COVER

MODEL	PAGE	R	V	A	U
SPECIFIC MODELS	380				(*)



// YOKE PROTECTOR

MODEL	PAGE	R	V	A	U
SPECIFIC MODELS	382				(*)



RADIKAL FUEL CAP COVER

HI-TECH PARTS

2019
MODELS:
www.puig.tv

MODEL	YEAR	REFERENCE	
APRILIA			
ALL	TO 07'	6294	(*)
ALL	08' - 18'	6296	(*)
SHIVER 900	17' - 18'	6294	(*)
BMW			
G310 GS	17' - 18'	9041	(*)
G310 R	16' - 18'	9041	(*)
R1200 R	15' - 18'	6825	(*)
R1200 RS	15' - 18'	6825	(*)
R1200GS	13' - 16'	6825	(*)
R1200GS	17' - 18'	6300	(*)
R1200GS EXCLUSIVE	17' - 18'	6300	(*)
R1200GS RALLYE	17' - 18'	6300	(*)
S1000 RR	15' - 16'	6300	(*)
S1000 XR	15' - 18'	6825	(*)
R NINE T URBAN G/S	17' - 18'	6300	(*)
R NINE T PURE	17' - 18'	6300	(*)
R NINE T RACER	17' - 18'	6300	(*)
ALL	TO 06'	6298	(*)
ALL	07' - 18'	6300	(*)
CAGIVA			
ALL		6294	(*)
DUCATI			
X DIAVEL	16' - 18'	8263	(*)
959 PANIGALE	16' - 18'	6306	(*)
PANIGALE V4	18'	6306	(*)
PANIGALE V4S	18'	6306	(*)
PANIGALE V4 SPECIALE	18'	6306	(*)
MULTISTRADA 950	17' - 18'	6306	(*)
MULTISTRADA 1200/S	15' - 17'	8263	(*)
MULTISTRADA 1200 PIKES PEAK	16' - 17'	8263	(*)
MULTISTRADA 1260/S/S DJAIR	18'	8263	(*)
MULTISTRADA 1260 PIKES PEAK	18'	8263	(*)
MONSTER 797	17' - 18'	6304	(*)
MONSTER 821	14' - 18'	6304	(*)
MONSTER 1200/S	14' - 16'	6304	(*)
MONSTER 1200/S	17' - 18'	6304	(*)
MONSTER 1200 R	16' - 18'	6304	(*)
SUPERSPORT 939/S	17' - 18'	6304	(*)
ALL	TO 08'	6304	(*)
ALL (1)	09' - 18'	6306	(*)
(1) EXCEPT: SCRAMBLER, HYPERSTRADA			(*)

MODEL	YEAR	REFERENCE	
HONDA			
CB125R NEO SPORTS CAFE	18'	7572	(*)
CB500F	16'	7572	(*)
CB500X	16'	7572	(*)
CBR500R	16'	7572	(*)
CMX500 REBEL	17' - 18'	7572	(*)
CROSSRUNNER	15' - 16'	7572	(*)
CB650F	17' - 18'	7572	(*)
CBR650F	17' - 18'	7572	(*)
CBR1000RR FIREBLADE/SP/SP2	17' - 18'	7572	(*)
ALL	TO 13'	6308	(*)
ALL	14' - 18'	7572	(*)
KAWASAKI			
NINJA 250R	08' - 12'	6314	(*)
NINJA 250SL	15' - 16'	8269	(*)
NINJA 300	13' - 18'	6314	(*)
NINJA 400	18'	9362	(*)
VERSYS 650	15' - 18'	6312	(*)
NINJA H2 SX	18'	9049	(*)
VERSYS-X 300	17' - 18'	9362	(*)
VERSYS 650	15' - 18'	6312	(*)
VERSYS 1000	15' - 18'	6312	(*)
VULCAN S	15' - 18'	6312	(*)
VULCAN S CAFE	17' - 18'	6312	(*)
Z125	17' - 18'	6312	(*)
Z250SL	15' - 16'	8269	(*)
Z300	15' - 17'	8269	(*)
Z650	17' - 18'	9362	(*)
Z900	17' - 18'	9362	(*)
Z900RS	18'	9049	(*)
Z1000SX	17' - 18'	6312	(*)
ZX-10R	16' - 18'	9049	(*)
ZX-10RR	17' - 18'	9049	(*)
ALL	00' - 05'	6310	(*)
ALL	06' - 18'	6312	(*)
KTM			
125 DUKE	11' - 16'	7611	(*)
125 DUKE	17' - 18'	7611	(*)
390 DUKE	13' - 16'	7611	(*)
390 DUKE	17' - 18'	7611	(*)
690 DUKE	16' - 18'	9051	(*)
690 DUKE R	16' - 17'	9051	(*)

MODEL	YEAR	REFERENCE	R A	V U
790 DUKE	18'	7611		(*)
1050 ADVENTURE	15' - 16'	8174		(*)
1190 ADVENTURE/R	13' - 16'	8174		(*)
1090 ADVENTURE/R	17' - 18'	8174		(*)
1290 SUPERDUKE R	17' - 18'	9447		(*)
1290 SUPER ADVENTURE	15' - 16'	8174		(*)
1290 SUPER ADVENTURE R	17' - 18'	9447		(*)
1290 SUPER ADVENTURE S	17' - 18'	9447		(*)
1290 SUPER ADVENTURE T	17'	9447		(*)
1290 SUPERDUKE GT	16' - 17'	8174		(*)
RC125/RC390	14' - 18'	7611		(*)
SUZUKI				
DL250 V-STROM	17' - 18'	6318		(*)
DL650 V-STROM	17' - 18'	9429		(*)
DL650XT V-STROM	17' - 18'	9429		(*)
DL1000 V-STROM	17' - 18'	9429		(*)
DL1000XT V-STROM	17' - 18'	9429		(*)
GSX-S125	17' - 18'	9965		(*)
GSX-S750	17' - 18'	9429		(*)
GSX-S1000	15' - 16'	6318		(*)
GSX-S1000F	15' - 16'	6318		(*)
GSX-R125	17' - 18'	9609		(*)
GSX-R250	17' - 18'	6318		(*)
GSX-R1000	15' - 16'	6318		(*)
GSX-R1000/R	17' - 18'	9429		(*)

MODEL	YEAR	REFERENCE	R A	V U
INAZUMA F	15' - 16'	6318		(*)
SV650	16'	6318		(*)
SV650X	18'	9429		(*)
ALL	96' - 02'	6316		(*)
ALL	03' - 18'	6318		(*)
TRIUMPH				
SPEED TRIPLE/R	16' - 18'	9053		(*)
STREET TRIPLE/R/S/RS	17' - 18'	9053		(*)
TIGER EXPLORER XC/XR/XRX/XRT/XCX/XCA	16' - 18'	9053		(*)
ALL		6294		(*)
YAMAHA				
MT-125	15' - 18'	7584		(*)
MT-10	16' - 18'	6324		(*)
MT-07	14' - 18'	6324		(*)
MT-09	17' - 18'	6324		(*)
MT-09 SP	18'	6324		(*)
XSR700	16' - 18'	6324		(*)
XSR900	16' - 18'	6324		(*)
YZF-R125	14' - 18'	7584		(*)
YZF-R1	15' - 16'	6324		(*)
YZF-R3	15' - 18'	8281		(*)
YZF-R6	17' - 18'	6324		(*)
ALL	TO 99'	6322		(*)
ALL	00' - 18'	6324		(*)

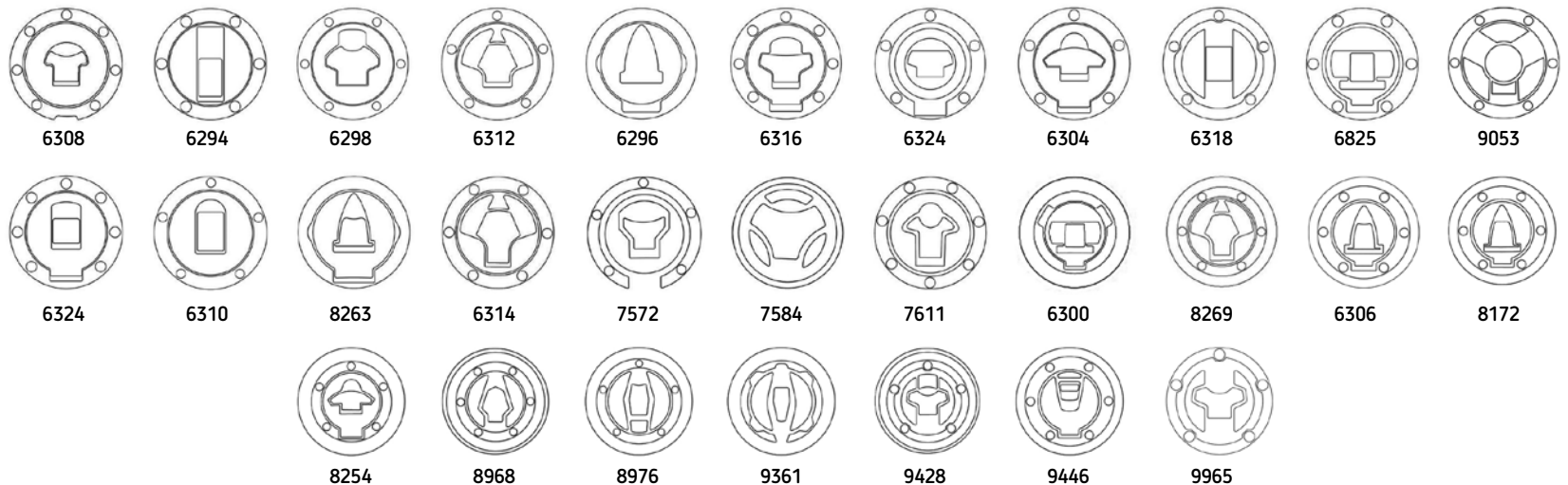

IMPORTANT: We recommend verify the design of the cap with the above diagrams when ordering.

MODEL	YEAR	REFERENCE YOKE	REFERENCE KEY CONTACT	
APRILIA				
RSV4	09' - 12'	6988		(*)
RSV4 FACTORY	13' - 14'	6988		(*)
RSV4 R	13' - 14'	9172		(*)
SHIVER 750	07' - 16'	6987		(*)
BMW				
F800 GS	08' - 17'	6985		(*)
F800 S	06' - 11'	6985		(*)
K1200 R SPORT	07' - 08'	6983		(*)
R1100 GS	94' - 99'	6982		(*)
R1150 GS	99' - 04'	6982		(*)
R1150 RS	01' - 05'	6986		(*)
R1200 GS	08' - 12'	6984		(*)
R NINE T	14' - 18'	7327		(*)
S1000 RR	09' - 14'	6981		(*)
S1000 RR	15' - 18'	8315		(*)
S1000 XR	15' - 18'	8316		(*)
DUCATI				
749/749S/999/999S	03' - 04'	6980		(*)
899 PANIGALE	14' - 15'	7326		(*)
959 PANIGALE	16' - 18'	7326		(*)
959 PANIGALE CORSE	18'	7326		(*)
1299 PANIGALE/S	15' - 17'	7326		(*)
DIAVEL	11' - 18'	6979		(*)
MONSTER 620	02' - 06'	6978		(*)
MONSTER 695	06' - 07'	6978		(*)
MONSTER 696	08' - 14'	6978		(*)
MONSTER 796	10' - 14'	6978		(*)
MONSTER 800	03' - 04'	6978		(*)
MONSTER 1000	02' - 05'	6978		(*)
MONSTER 1100	09' - 10'	6978		(*)
MONSTER 1100 EVO	11' - 13'	6978		(*)
MULTISTRADA 1200/S	10' - 14'	6977		(*)
HONDA				
CB600F HORNET	03' - 06'	6968		(*)
CB1100	13' - 14'	6904		(*)
CBR650F	14' - 18'	7330		(*)
CBR125R	11' - 18'	6976		(*)
CBR250R	11' - 14'	6975		(*)
CBR500R	13' - 15'	6907		(*)
CBR500R	16' - 18'	9073		(*)



MODEL	YEAR	REFERENCE YOKE	REFERENCE KEY CONTACT	
CBR600RR	90' - 94'	6973		(*)
CBR600RR	95' - 98'	6974		(*)
CBR600RR	99' - 02'	6972		(*)
CBR600RR	03' - 04'	6971		(*)
CBR600RR	05' - 06'	6970		(*)
CBR600RR	07' - 16'	6969		(*)
CBR900RR FIRE BLADE	98' - 99'	6967		(*)
CBR900RR FIRE BLADE	00' - 01'	6966		(*)
CBR900RR FIRE BLADE	02' - 03'	6966		(*)
CBR1000RR FIRE BLADE	04' - 07'	6965		(*)
CBR1000RR FIRE BLADE	08' - 13'	6964		(*)
CBR1000RR FIRE BLADE/SP	14' - 16'	6964		(*)
CBR1100XX BLACKBIRD	97' - 07'	6963		(*)
CROSSRUNNER	11' - 14'	6962		(*)
CRF1000L AFRICA TWIN	16' - 18'	9074		(*)
NC700S/X	12' - 13'	6961		(*)
NC750X	14' - 15'	6961		(*)
VFR800	98' - 01'	6960		(*)
VFR800	02' - 13'	6959		(*)
VFR800F	14' - 18'	7335		(*)
VFR1200F	10' - 16'	6958		(*)
KAWASAKI				
ER-6F	09' - 11'	6956		(*)
ER-6F	12' - 16'	6955		(*)
ER-6N	05' - 08'	6957		(*)
ER-6N	09' - 11'	6956		(*)
ER-6N	12' - 16'	6955		(*)
NINJA 250SL	15' - 16'	8320		(*)
NINJA 250R	08' - 12'	6954		(*)
NINJA 300	13' - 17'	6906		(*)
NINJA 400	18'	9626		(*)
NINJA 650	17' - 18'	9366		(*)
Z650	17' - 18'	9366		(*)
Z750	07' - 12'	6952		(*)
Z750R	11' - 12'	6952		(*)
Z750S	05' - 06'	6952		(*)
Z800/E	13' - 16'	6899		(*)
Z1000	03' - 06'	6952		(*)
Z1000	07' - 09'	6952		(*)
Z1000	10' - 13'	6953		(*)
Z1000	14' - 18'		7336	(*)

MODEL	YEAR	REFERENCE YOKE	REFERENCE KEY CONTACT	
Z1000SX	11' - 13'	6950		(*)
Z1000SX	14' - 16'	6950		(*)
Z1000SX	17' - 18'		9404	(*)
ZX-6R	03' - 04'	6945		(*)
ZX-6R	05' - 06'	6951		(*)
ZX-6R	07' - 08'	6949		(*)
ZX-6R	09' - 16'	6948		(*)
ZX-10R	06' - 10'	6947		(*)
ZX-10R	11' - 15'	6944		(*)
ZZR1400	06' - 15'	6943		(*)
KTM				
125 DUKE	17' - 18'	9490		(*)
390 DUKE	13' - 16'	9490		(*)
690 DUKE	16' - 18'	9077		(*)
690 DUKE R	16' - 17'	9077		(*)
RC125/RC390	14' - 18'	7680		(*)
MV AGUSTA				
F3 800	13' - 18'	6896		(*)
SUZUKI				
DL650 V-STROM	04' - 11'	6921		(*)
DL650 V-STROM	12' - 16'	6920		(*)
DL650XT V-STROM	15' - 16'	6920		(*)
DL1000 V-STROM	02' - 07'	6921		(*)
GSF650S BANDIT	07' - 14'	6946		(*)
GSF1250 BANDIT	07' - 11'	6922		(*)
GSF1250S BANDIT	07' - 11'	6922		(*)
GSR600	06' - 11'	6942	6991	(*)
GSR750	11' - 16'	6918	6990	(*)
GSX650F	08' - 17'	6917		(*)
GSX-S750	17' - 18'	9432		(*)
GSX-S1000	15' - 18'	8327		(*)
GSX-S1000F	15' - 18'	8327		(*)
GSX-R250	17' - 18'	9528		(*)
GSX-R600	01' - 03'	6916		(*)
GSX-R600	04' - 05'	6940		(*)
GSX-R600	06' - 16'	6938		(*)
GSX-R750	04' - 05'	6941		(*)
GSX-R750	06' - 16'	6938		(*)
GSX-R1000	01' - 02'	6937		(*)
GSX-R1000	03' - 04'	6939		(*)
GSX-R1000	05' - 06'	6936		(*)



MODEL	YEAR	REFERENCE YOKE	REFERENCE KEY CONTACT	
GSX-R1000	07' - 08'	6935		(*)
GSX-R1000	09' - 16'	6915		(*)
GSX-R1000/R	17' - 18'	9459		(*)
GSX-R1300 HAYABUSA	08' - 17'	6914		(*)
INAZUMA	13' - 17'	6905		(*)
SFV650 GLADIUS	09' - 15'	6919		(*)
SV650S	99' - 02'	6913		(*)
SV650S	03' - 08'	6934		(*)
SV650	16' - 18'	9078		(*)
SV650X	18'	9660		(*)
SV1000S	03' - 05'	6933		(*)
TRIUMPH				
DAYTONA 675	13' - 17'	6897		(*)
DAYTONA 675 R	13' - 17'	6897		(*)
YAMAHA				
FAZER8	13' - 16'	6927		(*)
FZ1	06' - 15'	6932		(*)
FZ1 FAZER	06' - 15'	6932		(*)
FZ6	04' - 08'	6911		(*)
FZ6 FAZER	04' - 08'	6911		(*)
FZ6 S2	09' - 10'	6931		(*)
FZ6 FAZER S2	07' - 10'	6931		(*)
FZ8	10' - 16'	6927		(*)
FZ8 FAZER	10' - 12'	6927		(*)
MT-03	06' - 13'		6989	(*)
XJ6	09' - 16'	6910		(*)
XJ6 DIVERSION	09' - 16'	6910		(*)
XJ6 DIVERSION F	10' - 16'	6910		(*)
YZF-R125	14' - 18'	7586		(*)
YZF-R1	02' - 03'	6925		(*)
YZF-R1	04' - 06'	6924		(*)
YZF-R1	07' - 08'	6928		(*)
YZF-R1	09' - 11'	6908		(*)
YZF-R1	12' - 14'	6923		(*)
YZF-R3	15' - 18'	8333		(*)
YZF-R6	99' - 02'	6909		(*)
YZF-R6	03' - 04'	6926		(*)
YZF-R6	05'	6930		(*)
YZF-R6	06' - 16'	6929		(*)
YZF-R6	17' - 18'	9845		(*)





// TANK PAD

MODEL	REF.	C
UNIVERSAL	7597C	(*)



// FUEL CAP COVER

MODEL	PAGE	C
SPECIFIC MODELS	388	(*)



// YOKE PROTECTOR

MODEL	PAGE	C
SPECIFIC MODELS	390	(*)



The central section of the tank pad is transparent.

X-TREME FUEL CAP COVER

HI-TECH PARTS

2019
MODELS:
www.puig.tv

MODEL	YEAR	REFERENCE	Ⓢ
APRILIA			
ALL	TO 07'	8375	(*)
ALL	08' - 18'	8376	(*)
SHIVER 900	17' - 18'	8375	(*)
BMW			
G310 GS	17' - 18'	9057	(*)
G310 R	16' - 18'	9057	(*)
R1200 R	15' - 18'	8379	(*)
R1200 RS	15' - 18'	8379	(*)
R1200GS	13' - 16'	8379	(*)
R1200GS	17' - 18'	8383	(*)
R1200GS EXCLUSIVE	17' - 18'	8383	(*)
R1200GS RALLYE	17' - 18'	8383	(*)
S1000 RR	15' - 16'	8383	(*)
S1000 XR	15' - 18'	8379	(*)
R NINE T URBAN G/S	17' - 18'	8383	(*)
R NINE T PURE	17' - 18'	8383	(*)
R NINE T RACER	17' - 18'	8383	(*)
ALL	TO 06'	8382	(*)
ALL	07' - 18'	8383	(*)
CAGIVA			
ALL		8375	(*)
DUCATI			
X DIAVEL	16' - 18'	8386	(*)
959 PANIGALE	16' - 18'	8386	(*)
PANIGALE V4	18'	8386	(*)
PANIGALE V4S	18'	8386	(*)
PANIGALE V4 SPECIALE	18'	8386	(*)
MULTISTRADA 950	17' - 18'	8384	(*)
MULTISTRADA 1200/S	15' - 17'	8384	(*)
MULTISTRADA 1200 PIKES PEAK	16' - 17'	8384	(*)
MULTISTRADA 1260/S/S DJAIR	18'	8384	(*)
MULTISTRADA 1260 PIKES PEAK	18'	8384	(*)
MONSTER 797	17' - 18'	8385	(*)
MONSTER 821	14' - 18'	8385	(*)
MONSTER 1200/S	14' - 16'	8385	(*)
MONSTER 1200/S	17' - 18'	8385	(*)
MONSTER 1200 R	16' - 18'	8385	(*)
SUPERSPORT 939/S	17' - 18'	8385	(*)
ALL	TO 08'	8385	(*)
ALL (1)	09' - 18'	8386	(*)
(1) EXCEPT: SCRAMBLER, HYPERSTRADA			(*)

MODEL	YEAR	REFERENCE	Ⓢ
HONDA			
CB125R NEO SPORTS CAFE	18'	8391	(*)
CB500F	16'	8391	(*)
CB500X	16'	8391	(*)
CBR500R	16'	8391	(*)
CMX500 REBEL	17' - 18'	8391	(*)
CROSSRUNNER	15' - 16'	8391	(*)
CB650F	17' - 18'	8391	(*)
CBR650F	17' - 18'	8391	(*)
CBR1000RR FIREBLADE/SP/SP2	17' - 18'	8391	(*)
ALL	TO 13'	8390	(*)
ALL	14' - 18'	8391	(*)
KAWASAKI			
NINJA 250R	08' - 12'	8394	(*)
NINJA 250SL	15' - 16'	8399	(*)
NINJA 300	13' - 18'	8394	(*)
NINJA 400	18'	9363	(*)
NINJA 650	17' - 18'	9363	(*)
NINJA H2 SX	18'	9065	(*)
VERSYS-X 300	17' - 18'	9363	(*)
VERSYS 650	15' - 18'	8402	(*)
VERSYS 1000	15' - 18'	8402	(*)
VULCAN S	15' - 18'	8402	(*)
VULCAN S CAFE	17' - 18'	8402	(*)
Z125	17' - 18'	8402	(*)
Z250SL	15' - 16'	8399	(*)
Z300	15' - 17'	8399	(*)
Z650	17' - 18'	9363	(*)
Z900	17' - 18'	9363	(*)
Z900RS	18'	9065	(*)
Z1000SX	17' - 18'	8402	(*)
ZX-10R	16' - 18'	9065	(*)
ZX-10RR	17' - 18'	9065	(*)
ALL	00' - 05'	8401	(*)
ALL	06' - 18'	8402	(*)
KTM			
125 DUKE	11' - 16'	8405	(*)
125 DUKE	17' - 18'	8405	(*)
390 DUKE	13' - 16'	8405	(*)
390 DUKE	17' - 18'	8405	(*)
690 DUKE	16' - 18'	9067	(*)
690 DUKE R	16' - 17'	9067	(*)

MODEL	YEAR	REFERENCE	Ⓒ
790 DUKE	18'	8405	(*)
1050 ADVENTURE	15' - 16'	8175	(*)
1190 ADVENTURE/R	13' - 16'	8175	(*)
1090 ADVENTURE/R	17' - 18'	8175	(*)
1290 SUPERDUKE R	17' - 18'	9448	(*)
1290 SUPER ADVENTURE	15' - 16'	8175	(*)
1290 SUPER ADVENTURE R	17' - 18'	9448	(*)
1290 SUPER ADVENTURE S	17' - 18'	9448	(*)
1290 SUPER ADVENTURE T	17'	9448	(*)
1290 SUPERDUKE GT	16' - 17'	8175	(*)
RC125/RC390	14' - 18'	8405	(*)
SUZUKI			
DL250 V-STROM	17' - 18'	8410	(*)
DL650 V-STROM	17' - 18'	9430	(*)
DL650XT V-STROM	17' - 18'	9430	(*)
DL1000 V-STROM	17' - 18'	9430	(*)
DL1000XT V-STROM	17' - 18'	9430	(*)
GSX-S125	17' - 18'	9966	(*)
GSX-S750	17' - 18'	9430	(*)
GSX-S1000	15' - 16'	8410	(*)
GSX-S1000F	15' - 16'	8410	(*)
GSX-R125	17' - 18'	9610	(*)
GSX-R250	17' - 18'	8410	(*)
GSX-R1000	15' - 16'	8410	(*)
GSX-R1000/R	17' - 18'	9430	(*)

MODEL	YEAR	REFERENCE	Ⓒ
INAZUMA F	15' - 16'	8410	(*)
SV650	16'	8410	(*)
SV650X	18'	9430	(*)
ALL	96' - 02'	8409	(*)
ALL	03' - 18'	8410	(*)
TRIUMPH			
SPEED TRIPLE/R	16' - 18'	9069	(*)
STREET TRIPLE/R/S/RS	17' - 18'	9069	(*)
TIGER EXPLORER XC/XR/XRX/XRT/XCX/XCA	16' - 18'	9069	(*)
ALL		8375	(*)
YAMAHA			
MT-125	15' - 18'	8414	(*)
MT-10	16' - 18'	8416	(*)
MT-07	14' - 18'	8416	(*)
MT-09	17' - 18'	8416	(*)
MT-09 SP	18'	8416	(*)
XSR700	16' - 18'	8416	(*)
XSR900	16' - 18'	8416	(*)
YZF-R125	14' - 18'	8414	(*)
YZF-R1	15' - 16'	8416	(*)
YZF-R3	15' - 18'	8413	(*)
YZF-R6	17' - 18'	8416	(*)
ALL	TO 99'	8415	(*)
ALL	00' - 18'	8416	(*)

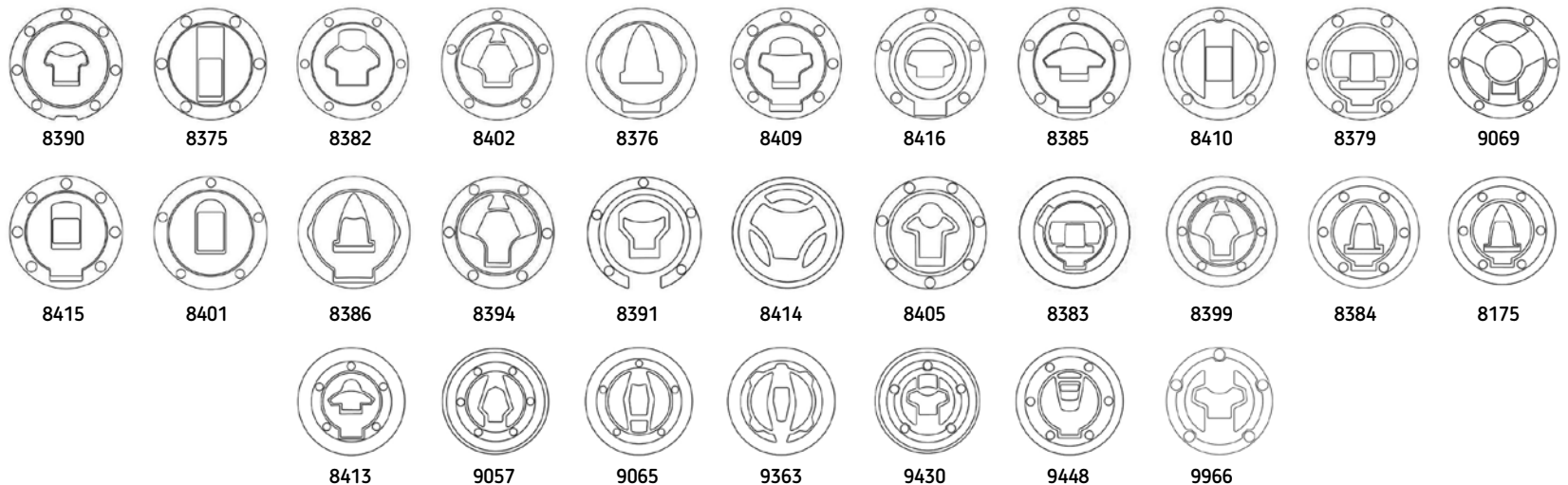

IMPORTANT: We recommend verify the design of the cap with the above diagrams when ordering.

X-TREME YOKE PROTECTORS

HI-TECH PARTS

2019
MODELS:
www.puig.tv

MODEL	YEAR	REFERENCE YOKE	REFERENCE KEY CONTACT	C
APRILIA				
RSV4	09' - 12'	5543		(*)
RSV4 FACTORY	13' - 14'	5543		(*)
RSV4 R	13' - 14'	9173		(*)
SHIVER 750	07' - 16'	5070		(*)
BMW				
F800 GS	08' - 17'	4574		(*)
F800 S	06' - 11'	4574		(*)
K1200 R SPORT	07' - 08'	4767		(*)
R1100 GS	94' - 99'	1567		(*)
R1150 GS	99' - 04'	1567		(*)
R1150 RS	01' - 05'	9092		(*)
R1200 GS	08' - 12'	5188		(*)
R NINE T	14' - 18'	9093		(*)
S1000 RR	09' - 14'	5400		(*)
S1000 RR	15' - 18'	9603		(*)
S1000 XR	15' - 18'	9095		(*)
DUCATI				
749/749S/999/999S	03' - 04'	1740		(*)
899 PANIGALE	14' - 15'	9091		(*)
959 PANIGALE	16' - 18'	9091		(*)
959 PANIGALE CORSE	18'	9091		(*)
1299 PANIGALE/S	15' - 17'	9091		(*)
DIAVEL	11' - 18'	5829		(*)
MONSTER 620	02' - 06'	1560		(*)
MONSTER 695	06' - 07'	1560		(*)
MONSTER 696	08' - 14'	1560		(*)
MONSTER 796	10' - 14'	1560		(*)
MONSTER 800	03' - 04'	1560		(*)
MONSTER 1000	02' - 05'	1560		(*)
MONSTER 1100	09' - 10'	1560		(*)
MONSTER 1100 EVO	11' - 13'	1560		(*)
MULTISTRADA 1200/S	10' - 14'	6233		(*)
HONDA				
CB600F HORNET	03' - 06'	9149		(*)
CB1100	13' - 14'	6689		(*)
CBR650F	14' - 18'	9096		(*)
CBR125R	11' - 18'	8631		(*)
CBR250R	11' - 14'	8395		(*)
CBR500R	13' - 15'	6692		(*)
CBR500R	16' - 18'	9098		(*)



MODEL	YEAR	REFERENCE YOKE	REFERENCE KEY CONTACT	Ⓒ
CBR600RR	90' - 94'	9099		(*)
CBR600RR	95' - 98'	9100		(*)
CBR600RR	99' - 02'	9101		(*)
CBR600RR	03' - 04'	1547		(*)
CBR600RR	05' - 06'	3994		(*)
CBR600RR	07' - 16'	4559		(*)
CBR900RR FIRE BLADE	98' - 99'	0974		(*)
CBR900RR FIRE BLADE	00' - 01'	1548		(*)
CBR900RR FIRE BLADE	02' - 03'	1548		(*)
CBR1000RR FIRE BLADE	04' - 07'	1957		(*)
CBR1000RR FIRE BLADE	08' - 13'	4759		(*)
CBR1000RR FIRE BLADE/SP	14' - 16'	4759		(*)
CBR1100XX BLACKBIRD	97' - 07'	0976		(*)
CROSSRUNNER	11' - 14'	5828		(*)
CRF1000L AFRICA TWIN	16' - 18'	9102		(*)
NC700S/X	12' - 13'	6225		(*)
NC750X	14' - 15'	6225		(*)
VFR800	98' - 01'	0103		(*)
VFR800	02' - 13'	1550		(*)
VFR800F	14' - 18'	9104		(*)
VFR1200F	10' - 16'	5938		(*)
KAWASAKI				
ER-6F	09' - 11'	5069		(*)
ER-6F	12' - 16'	6228		(*)
ER-6N	05' - 08'	4316		(*)
ER-6N	09' - 11'	5069		(*)
ER-6N	12' - 16'	6228		(*)
NINJA 250SL	15' - 16'	9105		(*)
NINJA 250R	08' - 12'	6238		(*)
NINJA 300	13' - 17'	6693		(*)
NINJA 400	18'	9627		(*)
NINJA 650	17' - 18'	9365		(*)
Z650	17' - 18'	9365		(*)
Z750	07' - 12'	1963		(*)
Z750R	11' - 12'	1963		(*)
Z750S	05' - 06'	1963		(*)
Z800/E	13' - 16'	6694		(*)
Z1000	03' - 06'	1963		(*)
Z1000	07' - 09'	1963		(*)
Z1000	10' - 13'	5399		(*)
Z1000	14' - 18'		9106	(*)

MODEL	YEAR	REFERENCE YOKE	REFERENCE KEY CONTACT	Ⓢ
Z1000SX	11' - 13'	5822		(*)
Z1000SX	14' - 16'	5822		(*)
Z1000SX	17' - 18'		9405	(*)
ZX-6R	03' - 04'	1557		(*)
ZX-6R	05' - 06'	4035		(*)
ZX-6R	07' - 08'	4563		(*)
ZX-6R	09' - 16'	5067		(*)
ZX-10R	06' - 10'	4229		(*)
ZX-10R	11' - 15'	5823		(*)
ZZR1400	06' - 15'	4570		(*)
KTM				
125 DUKE	17' - 18'	9491		(*)
390 DUKE	13' - 16'	9491		(*)
690 DUKE	16' - 18'	9109		(*)
690 DUKE R	16' - 17'	9109		(*)
RC125/RC390	14' - 18'	9110		(*)
MV AGUSTA				
F3 800	13' - 18'			(*)
SUZUKI				
DL650 V-STROM	04' - 11'	5187		(*)
DL650 V-STROM	12' - 16'	6231		(*)
DL650XT V-STROM	15' - 16'	6231		(*)
DL1000 V-STROM	02' - 07'	5187		(*)
GSF650S BANDIT	07' - 14'	4566		(*)
GSF1250 BANDIT	07' - 11'	4850		(*)
GSF1250S BANDIT	07' - 11'	4850		(*)
GSR600	06' - 11'	4343	4758	(*)
GSR750	11' - 16'	5817	6258	(*)
GSX650F	08' - 17'	4762		(*)
GSX-S750	17' - 18'	9433		(*)
GSX-S1000	15' - 18'			(*)
GSX-S1000F	15' - 18'	9112		(*)
GSX-R250	17' - 18'	9529		(*)
GSX-R600	01' - 03'	1147		(*)
GSX-R600	04' - 05'	1956		(*)
GSX-R600	06' - 16'	4231		(*)
GSX-R750	04' - 05'	1696		(*)
GSX-R750	06' - 16'	4231		(*)
GSX-R1000	01' - 02'	1552		(*)
GSX-R1000	03' - 04'	1594		(*)
GSX-R1000	05' - 06'	4036		(*)



MODEL	YEAR	REFERENCE YOKE	REFERENCE KEY CONTACT	Ⓒ
GSX-R1000	07' - 08'	4564		(*)
GSX-R1000	09' - 16'	5065		(*)
GSX-R1000/R	17' - 18'	9460		(*)
GSX-R1300 HAYABUSA	08' - 17'	4849		(*)
INAZUMA	13' - 17'	9113		(*)
SFV650 GLADIUS	09' - 15'			(*)
SV650S	99' - 02'	0006		(*)
SV650S	03' - 08'	1960		(*)
SV650	16' - 18'	9115		(*)
SV650X	18'	9661		(*)
SV1000S	03' - 05'	1961		(*)
TRIUMPH				
DAYTONA 675	13' - 17'	6697		(*)
DAYTONA 675 R	13' - 17'	6697		(*)
YAMAHA				
FAZER8	13' - 16'	5819		(*)
FZ1	06' - 15'	4599		(*)
FZ1 FAZER	06' - 15'	4599		(*)
FZ6	04' - 08'	4769		(*)
FZ6 FAZER	04' - 08'	4769		(*)
FZ6 S2	09' - 10'	4572		(*)
FZ6 FAZER S2	07' - 10'	4572		(*)
FZ8	10' - 16'	5819		(*)
FZ8 FAZER	10' - 12'	5819		(*)
MT-03	06' - 13'		9116	(*)
XJ6	09' - 16'	4975		(*)
XJ6 DIVERSION	09' - 16'	4975		(*)
XJ6 DIVERSION F	10' - 16'	4975		(*)
YZF-R125	14' - 18'	9120		(*)
YZF-R1	02' - 03'	1554		(*)
YZF-R1	04' - 06'	1962		(*)
YZF-R1	07' - 08'	4571		(*)
YZF-R1	09' - 11'	5063		(*)
YZF-R1	12' - 14'	6235		(*)
YZF-R3	15' - 18'	9121		(*)
YZF-R6	99' - 02'	0979		(*)
YZF-R6	03' - 04'	1739		(*)
YZF-R6	05'	4037		(*)
YZF-R6	06' - 16'	4230		(*)
YZF-R6	17' - 18'	9846		(*)

//// TANK PADS
HI-TECH PARTS



EASY MOUNTING PROCESS



ANTI-SCRATCH



IMPROVE GRIP



SOFT RUBBER FEEL

// TIRE

MODEL	REF.	PRICE
TIRE BLACK	9939N	(*)
TIRE TRANSPARENT	9939W	(*)

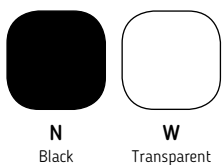

(*) Check price with your distributor.

IMPORTANT: Indicate code color after part#. Example: 0973A.



// LEATHER

MODEL	REF.	PRICE
LEATHER GREY	9304U	(*)
LEATHER BROWN	9304F	(*)
LEATHER BLACK	9304N	(*)
LEATHER CARBON LOOK	9304C	(*)

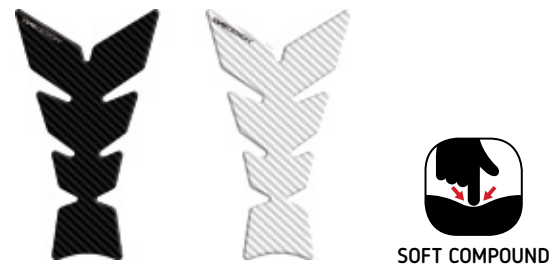
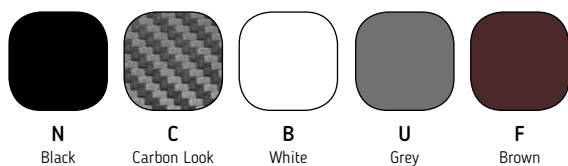

// SOFT

MODEL	REF.	PRICE
SOFT CARBON LOOK	8432C	(*)
SOFT WHITE	8432B	(*)

Because of its width might not get properly fit on tanks with pronounced curves.

(*) Check price with your distributor.

IMPORTANT: Indicate code color after part#. Example: 0973A.

PERFORMANCE TANK PADS

HI-TECH PARTS



MODEL	REF.	PRICE
PERFORMANCE CARBON LOOK	4051C	(*)
PERFORMANCE TRANSPARENT	4051W	(*)
PERFORMANCE SILVER	4051P	(*)
PERFORMANCE GREY	4051U	(*)
50TH ANNIVERSARY	7427C	(*)

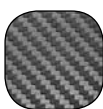

C
Carbon Look

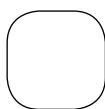

W
Transparent

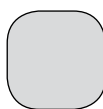

P
Silver



U
Grey

(*) Check price with your distributor.

IMPORTANT: Indicate code color after part#. Example: 0973A.

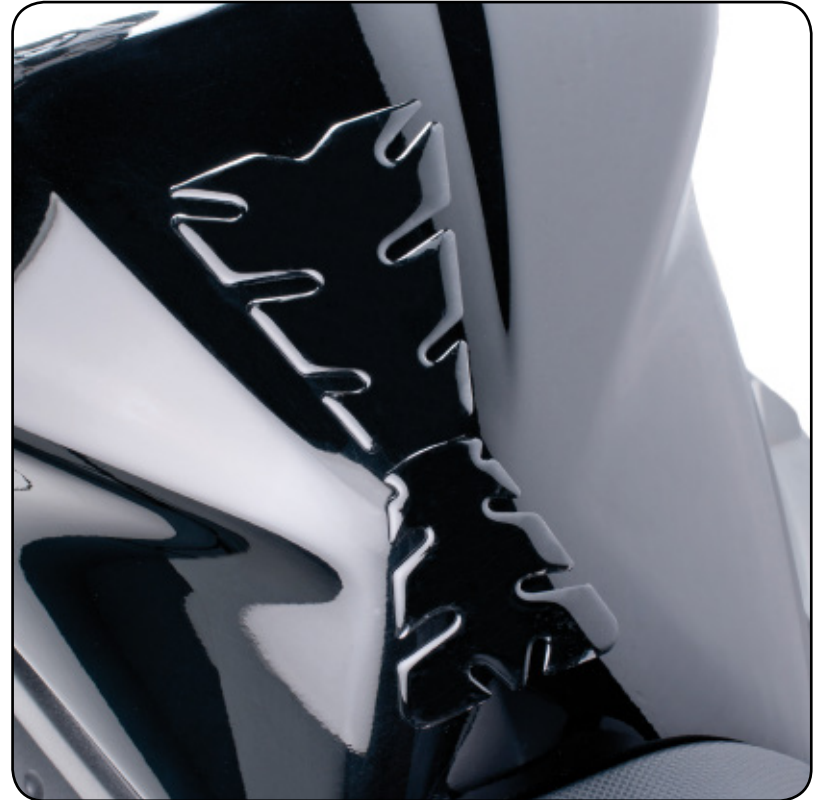

MODEL	REF.	PRICE
PERFORMANCE 2 CARBON LOOK	5876C	(*)
PERFORMANCE 2 TRANSPARENT	5876W	(*)

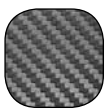

C
Carbon Look

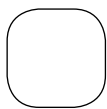

W
Transparent

(*) Check price with your distributor.

IMPORTANT: Indicate code color after part#. Example: 0973A.

//// TANK PADS WINGS

HI-TECH PARTS



MODEL	REFERENCE	PRICE
BMW	4718N	(*)
DUCATI	4719R	(*)
HONDA (3)	4785P	(*)
HONDA (4)	4785R	(*)
CBR (5)	4784A	(*)
CBR (6)	4784P	(*)
CBR (7)	4784R	(*)
KAWASAKI (8)	4720N	(*)
KAWASAKI (9)	4720V	(*)
NINJA (10)	4721V	(*)
NINJA (11)	4721R	(*)
SUZUKI	4724A	(*)
YAMAHA (12)	4722A	(*)
YAMAHA (13)	4722R	(*)
YZF (14)	4723A	(*)
YZF (15)	4723R	(*)
YZF (16)	4723P	(*)

(*) Check price with your distributor.

IMPORTANT: Indicate code color after part#. Example: 0973A.

//// SPIRIT TANK PADS

HI-TECH PARTS

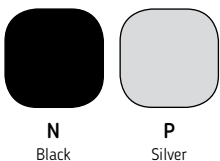

MODEL	N	P	PRICE
APRILIA			
RSV1000	4727N	4727P	(*)
SHIVER	5111N	5111P	(*)
BMW			
	5184N	5184P	(*)
DUCATI			
1098		4728P	(*)
MONSTER		4726P	(*)
MONSTER 696	5108N	5108P	(*)
HONDA			
CBR	4223N	4223P	(*)
CBF	4725N	4725P	(*)
HORNET	4228N	4228P	(*)
NC	9142N	9142P	(*)
HYOSUNG			
GT650	4729N	4729P	(*)
KAWASAKI			
ER6F	5112N	5112P	(*)
ER6N	4327N	4327P	(*)
NINJA	4221N	4221P	(*)
Z650	9306N	9306P	(*)
Z750	4328N	4328P	(*)
Z800	7484N	7484P	(*)
Z900	9307N	9307P	(*)
Z1000	4479N	4479P	(*)
SUZUKI			
BANDIT	4226N	4226P	(*)
GLAIDUS	5109N	5109P	(*)
GSR	4329N	4329P	(*)
SDXR	4222N	4222P	(*)
SV	4225N	4225P	(*)
TRIUMPH			
DAYTONA	4730N	4730P	(*)
YAMAHA			
FZ	4227N	4227P	(*)
FAZER	4341N	4341P	(*)
R6	4220N	4220P	(*)
R1	4219N	4219P	(*)
XJ6	5110N	5110P	(*)
MT	9143N	9143P	(*)
XSR	9308N	9308P	(*)
TRACER	9309N	9309P	(*)
UNIVERSAL			
RACING	4224N	4224P	(*)

(*) Check price with your distributor.

IMPORTANT: Indicate code color after part#. Example: 0973A.



//// TANK PADS

HI-TECH PARTS



// FUTURE

MODEL	REF.	PRICE
APRILIA	5631N	(*)
BMW	6460P	(*)
DUCATI	5633R	(*)
HONDA	5634R	(*)
KAWASAKI (1)	5630P	(*)
KAWASAKI (2)	5630V	(*)
SUZUKI	5632A	(*)
YAMAHA	5635P	(*)



// VIOLENT

MODEL	REF.	PRICE
VIOLENT BLUE	5519A	(*)
VIOLENT CARBON LOOK	5519C	(*)
VIOLENT BLACK	5519N	(*)
VIOLENT RED	5519R	(*)
VIOLENT GREEN	5519V	(*)
VIOLENT TRANSPARENT	5519W	(*)



A Blue V Green R Red N Black W Transparent C Carbon Look

(*) Check price with your distributor.

IMPORTANT: Indicate code color after part#. Example: 0973A.



// SPIRIT II

MODEL	REF.	PRICE
SPIRIT II BLUE	9140A	(*)
SPIRIT II ORANGE	9140T	(*)
SPIRIT II GREEN	9140V	(*)



SOFT COMPOUND

// ONE

MODEL	REF.	PRICE
ONE BLUE	9141A	(*)
ONE RED	9141R	(*)
ONE GREEN	9141V	(*)



R
Red

A
Blue

V
Green

T
Orange

(*) Check price with your distributor.

IMPORTANT: Indicate code color after part#. Example: 0973A.

//// TANK PADS

HI-TECH PARTS



// MOON

MODEL	REF.	PRICE
MOON RED (1)	9139R	(*)
MOON SILVER (2)	9139P	(*)
MOON ORANGE (3)	9139T	(*)

// SCREAM

MODEL	REF.	PRICE
SCREAM BLACK	9602N	(*)



R Red
P Silver
T Orange
N Black

(*) Check price with your distributor.

IMPORTANT: Indicate code color after part#. Example: 0973A.



// JOKER

MODEL	REF.	PRICE
JOKER GREY	6496U	(*)
JOKER GREEN	6496V	(*)
JOKER BLUE	6496A	(*)



// CLOWN

MODEL	REF.	PRICE
CLOWN GREY	9305U	(*)
CLOWN GREEN	9305V	(*)
CLOWN BLUE	9305A	(*)

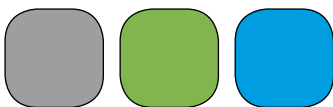

U
Grey

V
Green

A
Blue

(*) Check price with your distributor.

IMPORTANT: Indicate code color after part#. Example: 0973A.

//// TANK PADS
HI-TECH PARTS



// MINI

MODEL	REF.	PRICE
MINI CARBON LOOK	2560C	(*)

// ARROW

MODEL	REF.	PRICE
ARROW CARBON LOOK	2774C	(*)

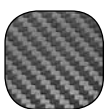

C
Carbon Look

(*) Check price with your distributor.

IMPORTANT: Indicate code color after part#. Example: 0973A.

**// WAY**

MODEL	REF.	PRICE
WAY BLACK	4478N	(*)
WAY CARBON LOOK	4478C	(*)

// SUN

MODEL	REF.	PRICE
SUN CARBON LOOK	4512C	(*)
SUN TRANSPARENT	4512W	(*)

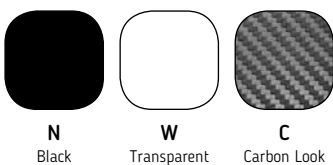

(*) Check price with your distributor.

IMPORTANT: Indicate code color after part#. Example: 0973A.

//// SHEETS

HI-TECH PARTS



// BUMPS-SHEET

MODEL	REF.	PRICE
1 SHEET COLOUR CARBON LOOK 250 x 350 mm.	4557C	(*)
1 SHEET COLOUR TRANSPAREN 250 x 350 mm.	4558W	(*)

GRIPPING ADHESIVE SHEET, DEVELOPED TO PROTECT CERTAIN PARTS FROM BEING SCRATCHED, AND TO IMPROVE THE GRIP OF THE RIDER.

SHEET SIZE: 250 x 350 mm.

// FLAT SHEET

MODEL	REF.	PRICE
1 SHEET COLOUR CARBON	4556C	(*)

SHEET SIZE: 320 x 460 mm.



// GRIPPING PADS

MODEL	REF.	PRICE
GRIPPING PADS BY PAIR 170 x 93,5 mm.	9310N	(*)

// NUMBERS



01
23
45
67
89

MODEL	PACK	REF.	PRICE
0	5 UNITS	4263	(*)
1	5 UNITS	4254	(*)
2	5 UNITS	4255	(*)
3	5 UNITS	4256	(*)
4	5 UNITS	4257	(*)
5	5 UNITS	4258	(*)
6	5 UNITS	4259	(*)
7	5 UNITS	4260	(*)
8	5 UNITS	4261	(*)
9	5 UNITS	4262	(*)
RACING	10 UNITS	4040	(*)
DISPLAY		2562N	(*)

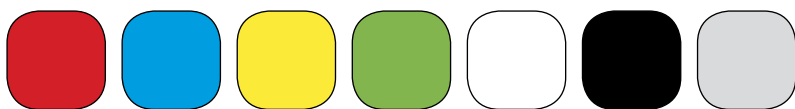

R
Red

A
Blue

G
Yellow

V
Green

B
White

N
Black

P
Silver

(*) Check price with your distributor.

IMPORTANT: Indicate code color after part#. Example: 0973A.



TURN SIGNAL

HOMOLOGATED

REF. 4487K	12V 2W
REF. 4488K	12V 1W
REF. 4489K	12V 1W
REF. 4490K	12V 2W



MODEL	YEAR	REF.	PRICE
HONDA			
CB500F/X	13' - 18'	4487K	(*)
CB600F HORNET	05' - 16'	4487K	(*)
CB900F HORNET	02' - 05'	4487K	(*)
CB650F	14' - 16'	4487K	(*)
CB1000R	08' - 16'	4487K	(*)
CBF1000F	10' - 16'	4487K	(*)
CBR600F	99' - 07'	4487K	(*)
CBR600F	11' - 14'	4487K	(*)
CBR650F	14' - 16'	4487K	(*)
CBR500R	13' - 18'	4487K	(*)
CBR600RR	03' - 16'	4487K	(*)
CBR900RR FIRE BLADE	98' - 03'	4487K	(*)
CBR1000RR	04' - 16'	4487K	(*)
CROSSRUNNER	11' - 18'	4487K	(*)
CROSTOURER	14' - 18'	4487K	(*)

MODEL	YEAR	REF.	PRICE
NC700S/X	12' - 13'	4487K	(*)
NC750S/X	14' - 18'	4487K	(*)
MSX125	14' - 18'	4487K	(*)
KAWASAKI			
VERSYS 650	07' - 09'	4490K	(*)
Z750	07' - 12'	4490K	(*)
Z750S	05' - 06'	4490K	(*)
ZR7S	01' - 03'	4490K	(*)
ZRX1200S	01' - 07'	4490K	(*)
ZX-6R	94' - 04'	4490K	(*)
ZX-9R	94' - 04'	4490K	(*)
ZX-10R	04' - 05'	4490K	(*)
ZX-12R	00' - 06'	4490K	(*)
SUZUKI			
DL650A V-STROM	12' - 16'	4488K	(*)
DL650XT V-STROM	15' - 16'	4488K	(*)
DL1000 V-STROM	14' - 16'	4488K	(*)
GSF600 BANDIT	00' - 04'	4488K	(*)
GSF650 BANDIT	05' - 11'	4488K	(*)
GSF650S BANDIT	05' - 14'	4488K	(*)
GSF1200 BANDIT	01' - 06'	4488K	(*)
GSF1250S BANDIT	07' - 13'	4488K	(*)
GSR750	11' - 16'	4488K	(*)
GSX650F	08' - 17'	4488K	(*)
GSX1250F	10' - 17'	4488K	(*)
GSX-R600/750	01' - 05'	4488K	(*)
GSX-R1000	01' - 04'	4488K	(*)
GSX-S1000	15' - 17'	4488K	(*)
GSX-S1000F	15' - 17'	4488K	(*)
SFV650 GLADIUS	09' - 15'	4488K	(*)
SV650S	03' - 08'	4488K	(*)
YAMAHA			
FZ1/FAZER	06' - 15'	4489K	(*)
FZ6/FAZER	04' - 08'	4489K	(*)
FZ8/FAZER		4489K	(*)
FAZER8	13' - 16'	4489K	(*)
MT-09	13' - 16'	4489K	(*)
MT-09 TRACER	15' - 17'	4489K	(*)
MT-07	14' - 17'	4489K	(*)
TDM900	02' - 13'	4489K	(*)
XJ6/DIVERSION/F		4489K	(*)
XSR700	16' - 18'	4489K	(*)
YZF-R1	02' - 14'	4489K	(*)
YZF-R3	15' - 17'	4489K	(*)
YZF-R6	03' - 16'	4489K	(*)

Technical characteristics: 12V 0,5W

TO AVOID CONNECTION PROBLEMS, SEE THE DATASHEET ON PAGE 430





MATERIAL
Manufactured in steel.
Finished with epoxy paint.



OPTICS
Hides the gap that leaves
the OEM turn signal when
it is replaced.

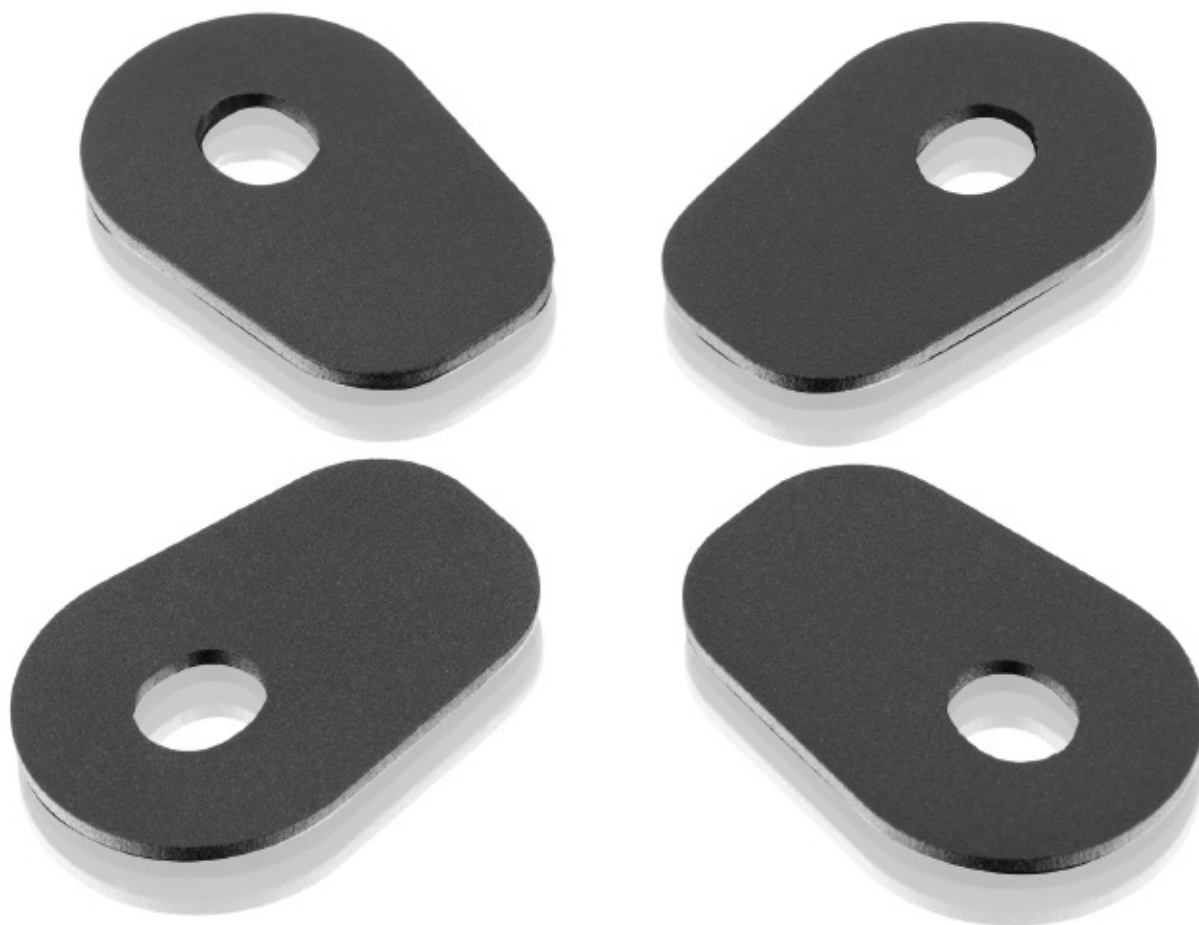

TURN SIGNAL COVERS

HI-TECH PARTS

2019
 MODELS:
www.puig.tv

MODEL	YEAR	REF.	N
HARLEY DAVIDSON			
SPORTSTER 883 IRON	16'-18'	9735 (#)	(*)
HONDA			
CB125F	15' - 18'	3957	(*)
CB300F	15' - 18'	3957	(*)
CB500F/X	13' - 18'	3957	(*)
CB600F HORNET	00' - 15'	3957	(*)
CB650F	14' - 18'	3957	(*)
CB900F HORNET	02' - 05'	3957	(*)
CB125R NEO SPORTS CAFE	18'	9655	(*)
CB300R NEO SPORTS CAFE	18'	9655	(*)
CB1000R	08' - 16'	3957	(*)
CBF1000F	10' - 16'	3957	(*)
CBR600F	86' - 13'	3957	(*)
CBR600F	86' - 13'	3957	(*)
CBR650F	14' - 18'	3957	(*)
CBR125R	11' - 18'	3957	(*)
CBR250R	11' - 14'	3957	(*)
CBR300R	15' - 17'	3957	(*)
CBR500R	13' - 18'	3957	(*)
CBR600RR	03' - 16'	3957	(*)
CBR1000RR FIREBLADE	04' - 13'	3957	(*)
CBR1000RR FIREBLADE/SP	14' - 16'	3957	(*)
CROSSRUNNER	11' - 18'	3957	(*)
CROSSTOURER	12' - 18'	3957	(*)
CMX 500 REBEL	17' - 18'	9672 (#)	(*)
INTEGRA 750	16' - 18'	3957	(*)
NC700S/X	12' - 13'	3957	(*)
NC750S/X	14' - 18'	3957	(*)
MSX125	14' - 18'	3957	(*)
INDIAN			
SCOUT BOBBER	18'	9740 (#)	(*)
SCOUT BOBBER	18'	9765 (&)	(*)
KAWASAKI			
ER-6N/F	12' - 16'	5329	(*)
NINJA 250SL	15' - 16'	5329	(*)
NINJA 300	13' - 17'	5329	(*)
NINJA 400	18'	5329	(*)
NINJA 650	17' - 18'	5329	(*)
VERSYS-X 300	17' - 18'	5329	(*)
VERSYS 650	07' - 09'	3959	(*)
VERSYS 650	10' - 18'	5329	(*)
VERSYS 1000	12' - 18'	5329	(*)
VULCAN S	15' - 18'	9676 (#)	(*)
VULCAN S CAFE	17' - 18'	9676 (#)	(*)
Z250SL	15' - 16'	5329	(*)
Z650	17' - 18'	5329	(*)
Z300	15' - 17'	5329	(*)
Z750	07' - 12'	3959	(*)
Z750S	05' - 06'	3959	(*)

MODEL	YEAR	REF.	N
Z750R	11' - 12'	5329	(*)
Z800/E	13' - 16'	5329	(*)
Z900	17' - 18'	5329	(*)
Z900	17' - 18'	9788	(*)
Z900RS	18'	5329	(*)
Z1000	10' - 18'	5329	(*)
Z1000R	17' - 18'	5329	(*)
Z1000SX	14' - 18'	5329	(*)
ZR7S	01' - 03'	3959	(*)
ZRX1200S	01' - 07'	3959	(*)
ZX-6R	94' - 04'	3959	(*)
ZX-6R 636	13' - 16'	5329	(*)
ZX-9R	94' - 04'	3959	(*)
ZX-10R	04' - 05'	3959	(*)
ZX-10R	08' - 10'	4751	(*)
ZX-10R	16' - 18'	4751	(*)
ZX-10RR	17' - 18'	4751	(*)
ZX-12R	00' - 06'	3959	(*)
SUZUKI			
DL250 V-STROM	17' - 18'	3956	(*)
DL650 V-STROM	12' - 18'	3958	(*)
DL650XT V-STROM	15' - 18'	3958	(*)
DL1000 V-STROM	14' - 18'	3958	(*)
DL1000XT V-STROM	17' - 18'	3958	(*)
GSF600 BANDIT	96' - 99'	3956	(*)
GSF600 BANDIT	00' - 04'	3958	(*)
GSF650 BANDIT	05' - 11'	3958	(*)
GSF650S BANDIT	05' - 14'	3958	(*)
GSF1200 BANDIT	01' - 06'	3958	(*)
GSF1250S BANDIT	07' - 13'	3958	(*)
GSF1250S BANDIT	15' - 16'	3958	(*)
GSR750	11' - 16'	3958	(*)
GSX650F	08' - 17'	3958	(*)
GSX1250F	10' - 17'	3958	(*)
GSX-S125	17' - 18'	3956	(*)
GSX-S750	17' - 18'	3958	(*)
GSX-S1000	15' - 18'	3958	(*)
GSX-S1000F	15' - 18'	3958	(*)
GSX-R125	17' - 18'	3956	(*)
GSX-R250	17' - 18'	3956	(*)
GSX-R600/750	96' - 00'	3956	(*)
GSX-R600/750	01' - 05'	3958	(*)
GSX-R1000	01' - 04'	3958	(*)
GSX-R1000	15' - 16'	3958	(*)
GSX-R1000/R	17' - 18'	9453	(*)
INAZUMA	13' - 17'	3956	(*)
SFV650 GLADIUS	09' - 15'	3958	(*)
SV650S	03' - 08'	3958	(*)
SV650	16' - 18'	3958	(*)
SV1000S	03' - 05'	3956	(*)

MODEL	YEAR	REF.	N
YAMAHA			
FAZER8	13' - 16'	3960	(*)
FJR1300A/AS	06' - 18'	3959	(*)
FZ1/FAZER	06' - 15'	3960	(*)
FZ6	04' - 06'	3960	(*)
FZ6 FAZER	07' - 08'	3960	(*)
FZ8 FAZER	10' - 12'	3960	(*)
FZS600/1000 FAZER	01' - 05'	3959	(*)
MT-03	16' - 18'	3960	(*)
MT-09	13' - 16'	3960	(*)
MT-09 (SET TO SUBSTITUTE TURN SIGNALS POSITION)	17' - 18'	9465	(*)
MT-09 SP (SET TO SUBSTITUTE TURN SIGNALS POSITION)	18'	9465	(*)
MT-09 TRACER	15' - 18'	3960	(*)
MT-09 TRACER GT	18'	3960	(*)
MT-10	16' - 18'	3960	(*)
MT-10 SP	17' - 18'	3960	(*)

MODEL	YEAR	REF.	N
MT-07	14' - 18'	3960	(*)
MT-07 TRACER	16' - 18'	3960	(*)
TDM900	02' - 13'	3960	(*)
XJ6	09' - 16'	3960	(*)
XJ6 DIVERSION	09' - 16'	3960	(*)
XJ6 DIVERSION F	10' - 16'	3960	(*)
XSR700	16' - 18'	3960	(*)
XSR900	16' - 18'	3960	(*)
XT660Z TÉNÉRÉ	12' - 18'	3959	(*)
YZF 600 R THUNDERCAT	96' - 02'	3959	(*)
YZF 1000 R THUNDERACE	96' - 03'	3959	(*)
YZF-R1	98' - 01'	3959	(*)
YZF-R1	02' - 14'	3960	(*)
YZF-R3	15' - 18'	3960	(*)
YZF-R6	99' - 02'	3959	(*)
YZF-R6	03' - 16'	3960	(*)
YZF-R6	17' - 18'	3960	(*)

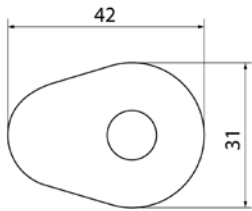

REF. 3956

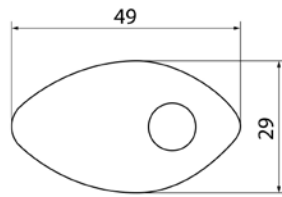

REF. 3957

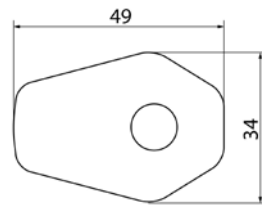

REF. 3958

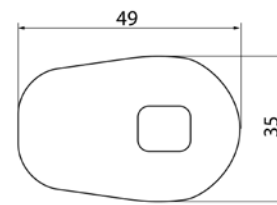

REF. 3959

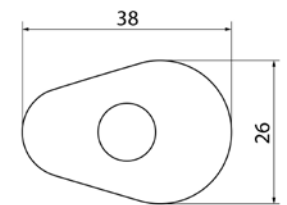

REF. 3960

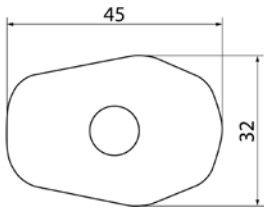

REF. 4751

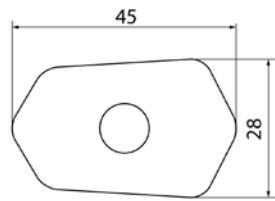

REF. 5329

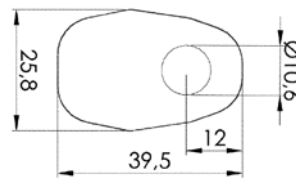

REF. 9453

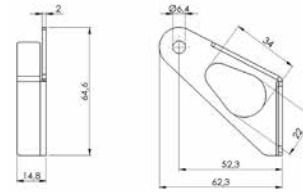

REF. 9465

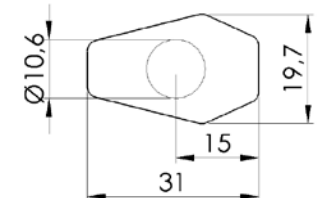

REF. 9655

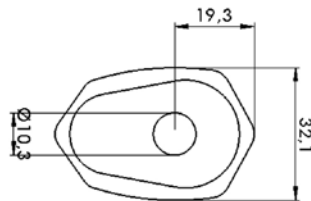

REF. 9788

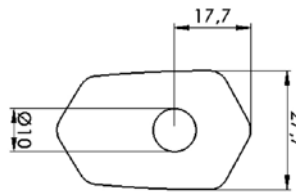

REF. 9788

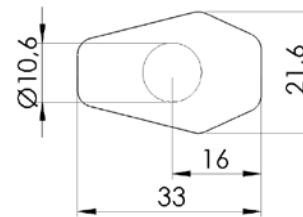

REF. 9655



N
Black

(#) Bracket set front Puig turn signals.
 (8) Bracket set rear Puig turn signals.
 (*) Check price with your distributor.

IMPORTANT: Indicate code color after part#. Example: 0973A.





// THIN

HOMOLOGATED

MODEL	REF.	PRICE
SET OF SEQUENTIAL COLOR BLACK WITH CLEAR LENS OF 12 LEDS 75 x 15 mm.	9624N	(*)

// PIN

HOMOLOGATED

MODEL	REF.	PRICE
SET OF SEQUENTIAL COLOR BLACK WITH CLEAR LENS OF 12 LEDS 65 x 11 mm.	3155N	(*)



N
Black



TURN SIGNAL



FRONT RUNNING LIGHT



REAR POSITION LIGHT



STOP LIGHT



N
Black

CHECK CONNECTIONS TURN SIGNALS ON **PAGE 429**
TO AVOID CONECTIONS PROBLEMS. CHECK THE TECHNICAL SHEET ON **PAGE 430**

TURN SIGNALS

HI-TECH PARTS



// PIRAMIDE

HOMOLOGATED

MODEL	REF.	PRICE
SET BLACK CLEAR LENSES LED 58 x 32 mm. 12V 0,5W	9941N	(*)



// CHIP

HOMOLOGATED

MODEL	REF.	PRICE
SET BLACK CLEAR LENSES LED 24 x 16 mm. 12V 0,4W	9942N	(*)



N
Black



TURN SIGNAL



FRONT RUNNING LIGHT



REAR POSITION LIGHT



STOP LIGHT



N
Black

CHECK CONNECTIONS TURN SIGNALS ON **PAGE 429**
TO AVOID CONNECTIONS PROBLEMS. CHECK THE TECHNICAL SHEET ON **PAGE 430**



// SPARKLY

HOMOLOGATED

MODEL	REF.	PRICE
SET BLACK CLEAR LENSES LED 80 x 22 mm. 12V 0,5W	9944N	(*)



// HOUSE

HOMOLOGATED

MODEL	REF.	PRICE
SET BLACK CLEAR LENSES LED 70 x 24 mm. 12V 0,5W	9946N	(*)



N
Black



TURN SIGNAL



FRONT RUNNING LIGHT



REAR POSITION LIGHT



STOP LIGHT



N
Black

CHECK CONNECTIONS TURN SIGNALS ON **PAGE 429**
TO AVOID CONNECTIONS PROBLEMS. CHECK THE TECHNICAL SHEET ON **PAGE 430**

TURN SIGNALS

HI-TECH PARTS



// BUOY

HOMOLOGATED

MODEL	REF.	PRICE
SET BLACK CLEAR LENSES LED 66 x 29 mm. 12V 5W	9947N	(*)



// BUOY II

HOMOLOGATED

MODEL	REF.	PRICE
SET BLACK CLEAR LENSES LED 64 x 37 mm. 12V 5W	9948N	(*)



N
Black



TURN SIGNAL



FRONT RUNNING LIGHT



REAR POSITION LIGHT



STOP LIGHT



N
Black

CHECK CONNECTIONS TURN SIGNALS ON **PAGE 429**
TO AVOID CONNECTIONS PROBLEMS. CHECK THE TECHNICAL SHEET ON **PAGE 430**



// TINY

HOMOLOGATED

MODEL	REF.	PRICE
SET OF BLACK COLOR WITH SMOKED LENSES OF 30 x 30 mm. 12V 1W	9314N	(*)



// MINIMAL

HOMOLOGATED

MODEL	REF.	PRICE
LED TURN SIGNAL BLACK BASE SHORT STEMP/ CLEAR LENS BY PAIR 32 x 18 mm. 12V 0,6W	4906N	(*)
LED TURN SIGNAL BLACK BASE SHORT STEMP/ CLEAR LENS BY PAIR 55 x 18 mm. 12V 0,8W	4907N	(*)



N
Black



TURN SIGNAL



FRONT RUNNING LIGHT



REAR POSITION LIGHT



STOP LIGHT



N
Black

CHECK CONNECTIONS TURN SIGNALS ON **PAGE 429**
TO AVOID CONECTIONS PROBLEMS. CHECK THE TECHNICAL SHEET ON **PAGE 430**

TURN SIGNALS

HI-TECH PARTS

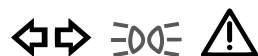

// LIGHT

HOMOLOGATED

MODEL	REF.	PRICE
FRONT SET OF BLACK COLOR WITH SMOKED LENSES OF 60 x 25 mm. POSITION + TURN SIGNAL	9315N	(*)
REAR SET OF BLACK COLOR WITH SMOKED LENSES OF 60 x 25 mm. POSITION + STOP + TURN SIGNAL	9557N	(*)



// DOUBLE

HOMOLOGATED

MODEL	REF.	PRICE
FRONT SET OF BLACK COLOR WITH SMOKED LENSES OF 60 x 40 mm. POSITION + TURN SIGNAL	9316N	(*)
REAR SET OF BLACK COLOR WITH SMOKED LENSES OF 60 x 40 mm. POSITION + STOP + TURN SIGNAL	9556N	(*)



N
Black



TURN SIGNAL



FRONT RUNNING LIGHT



REAR POSITION LIGHT



STOP LIGHT



N
Black

CHECK CONNECTIONS TURN SIGNALS ON [PAGE 429](#)
TO AVOID CONNECTIONS PROBLEMS. CHECK THE TECHNICAL SHEET ON [PAGE 430](#)



// STICK

HOMOLOGATED

MODEL	REF.	PRICE
FRONT SET OF BLACK COLOR WITH SMOKED LENSES OF 70 x 20 mm. POSITION + TURN SIGNAL	9317N	(*)
REAR SET OF BLACK COLOR WITH SMOKED LENSES OF 70 x 20 mm. POSITION + STOP + TURN SIGNAL	9555N	(*)

// OPEN

HOMOLOGATED

MODEL	REF.	PRICE
SET BLACK CLEAR LENSES LED 60 x 25 mm. 12V 2W	8997N	(*)



N
Black



TURN SIGNAL



FRONT RUNNING LIGHT



REAR POSITION LIGHT



STOP LIGHT



N
Black

CHECK CONNECTIONS TURN SIGNALS ON **PAGE 429**
TO AVOID CONNECTIONS PROBLEMS. CHECK THE TECHNICAL SHEET ON **PAGE 430**

TURN SIGNALS

HI-TECH PARTS

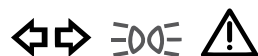

// CURVE

HOMOLOGATED

MODEL	REF.	PRICE
FRONT LED TURN SIGNAL BLACK BASE/ CLEAR LENS BY PAIR 60 x 25 mm. POSITION + TURN SIGNAL	9084N	(*)
REAR LED TURN SIGNAL BLACK BASE/ CLEAR LENS BY PAIR 60 x 25 mm. POSITION + STOP + TURN SIGNAL	9151N	(*)

// POWER LED

HOMOLOGATED

MODEL	REF.	PRICE
SET BLACK CLEAR LENSES LED 50 x 20 mm. 12V 1W	5609N	(*)



N
Black



TURN SIGNAL



FRONT RUNNING LIGHT



REAR POSITION LIGHT



STOP LIGHT



N
Black

CHECK CONNECTIONS TURN SIGNALS ON **PAGE 429**
TO AVOID CONNECTIONS PROBLEMS. CHECK THE TECHNICAL SHEET ON **PAGE 430**



// DID

HOMOLOGATED

MODEL	REF.	PRICE
SET BLACK CLEAR LENSES LED 65 x 15 mm. 12V 2W	6074N	(*)



// AX

HOMOLOGATED

MODEL	REF.	PRICE
SET BLACK CLEAR LENSES LED 65 x 17 mm. 12V 1W	5510N	(*)

N
Black

TURN SIGNAL



FRONT RUNNING LIGHT



REAR POSITION LIGHT



STOP LIGHT

N
Black

CHECK CONNECTIONS TURN SIGNALS ON PAGE 429
TO AVOID CONNECTIONS PROBLEMS. CHECK THE TECHNICAL SHEET ON PAGE 430

TURN SIGNALS

HI-TECH PARTS



// SNAKE

HOMOLOGATED

MODEL	REF.	PRICE
SET BLACK CLEAR LENSES LED 80 x 27 mm. 12V 1W	5239N	(*)



// FLECHA

HOMOLOGATED

MODEL	REF.	PRICE
LED TURN SIGNAL CARBON LOOK BASE SHORT STEMP/ CLEAR LENS BY PAIR 65 x 35 mm. 12V 2W	4173W	(*)
LED TURN SIGNAL CARBON LOOK BASE LONG STEMP/ CLEAR LENS BY PAIR 85 x 35 mm. 12V 2W	4174W	(*)



N
Black



TURN SIGNAL



FRONT RUNNING LIGHT



REAR POSITION LIGHT



STOP LIGHT

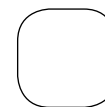

W
Transparent

CHECK CONNECTIONS TURN SIGNALS ON **PAGE 429**
TO AVOID CONNECTIONS PROBLEMS. CHECK THE TECHNICAL SHEET ON **PAGE 430**



// ZAFIRO

HOMOLOGATED

MODEL	REF.	PRICE
LED TURN SIGNAL CARBON LOOK BASE SHORT STEMP/ CLEAR LENS BY PAIR 75 x 30 mm. 12V 1W	2585W	(*)
LED TURN SIGNAL CARBON LOOK BASE LONG STEMP/ CLEAR LENS BY PAIR 95 x 30 mm.	2586W	(*)

// LANZA

HOMOLOGATED

MODEL	REF.	PRICE
LED TURN SIGNAL ALUMINIUM BASE/ CLEAR LENS BY PAIR 79 x 33 mm. 12V 0,9W	4824D	(*)
LED TURN SIGNAL BLACK BASE/ CLEAR LENS BY PAIR 79 x 33 mm.12V 0,9W	4824N	(*)

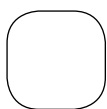

W
Transparent



TURN SIGNAL



FRONT RUNNING LIGHT



REAR POSITION LIGHT



STOP LIGHT



N
Black

D
Anodized

CHECK CONNECTIONS TURN SIGNALS ON **PAGE 429**
TO AVOID CONECTIONS PROBLEMS. CHECK THE TECHNICAL SHEET ON **PAGE 430**

TURN SIGNALS

HI-TECH PARTS



// PEAK

HOMOLOGATED

MODEL	REF.	PRICE
LED TURN SIGNAL BLACK BASE SHORT STEM/ CLEAR LENS BY PAIR 65 x 27 mm. 12V 0,5W	4491N	(*)
LED TURN SIGNAL BLACK BASE LONG STEM/ CLEAR LENS BY PAIR 85 x 27 mm. 12V 0,5W	4492N	(*)
LED TURN SIGNAL CARBON LOOK BASE SHORT STEM/ CLEAR LENS BY PAIR 65 x 27 mm. 12V 0,5W	4493C	(*)
LED TURN SIGNAL CARBON LOOK BASE LONG STEM/ CLEAR LENS BY 85 x 27 mm. 12V 0,5W	4494C	(*)

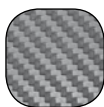

C
Carbon Look



TURN SIGNAL



FRONT RUNNING LIGHT



REAR POSITION LIGHT



STOP LIGHT



N
Black

CHECK CONNECTIONS TURN SIGNALS ON **PAGE 429**
TO AVOID CONNECTIONS PROBLEMS. CHECK THE TECHNICAL SHEET ON **PAGE 430**



// CIGAR

HOMOLOGATED

MODEL	REF.	PRICE
LED TURN SIGNAL BLACK BASE/ CLEAR LENS BY PAIR 90 x 25 mm. 12V 1,4W	4346N	(*)



// BALA

HOMOLOGATED

MODEL	REF.	PRICE
BLACK BASE/ AMBER LEN x UNIT 70 x 80 mm.	0911T	(*)



N
Black



TURN SIGNAL



FRONT RUNNING LIGHT



REAR POSITION LIGHT



STOP LIGHT

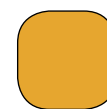

T
Orange

CHECK CONNECTIONS TURN SIGNALS ON **PAGE 429**
TO AVOID CONNECTIONS PROBLEMS. CHECK THE TECHNICAL SHEET ON **PAGE 430**

TURN SIGNALS

HI-TECH PARTS



// SPEED

HOMOLOGATED

MODEL	REF.	PRICE
BLACK BASE/ AMBER LENS BY PAIR 60 x 23 mm.	(*) 2546T	(*)
CARBON LOOK BASE/ AMBER LENS BY PAIR 60 x 23 mm. 12V 2,16W	(*) 1077T	(*)

(*) These models cannot be homologated, because do not fulfill the EU standards, their C-Carbon Look use limited for tradeshows exclusively, closed exhibitions and for race tracks.

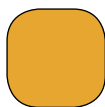

T
Orange



TURN SIGNAL



FRONT RUNNING LIGHT



REAR POSITION LIGHT



STOP LIGHT

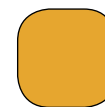

T
Orange

CHECK CONNECTIONS TURN SIGNALS ON **PAGE 429**
TO AVOID CONNECTIONS PROBLEMS. CHECK THE TECHNICAL SHEET ON **PAGE 430**

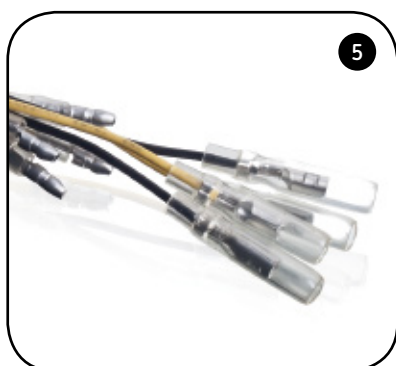
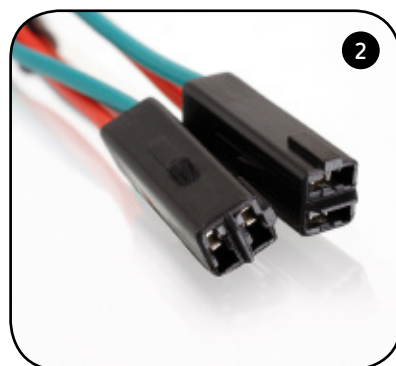
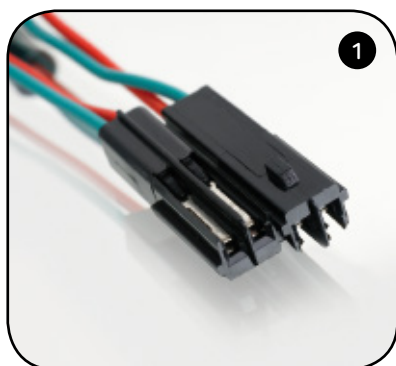

// CONN. LEADS

MODEL	REF.	DIMENSIONS LEADS MM	PRICE
MODELS HONDA	4854N (1)	180 mm.	(*)
MODELS HONDA (CB1000R / CB65F 15' - 16')	8510N (6)	110 mm.	(*)
MODELS KAWASAKI	4856N (2)	180 mm.	(*)
MODELS SUZUKI	4860N (3)	180 mm.	(*)
MODELS YAMAHA	4863N (4)	320 mm.	(*)
MODELS TRIUMPH	9772N (7)	200 mm.	(*)
MODEL UNIVERSAL	4869N (5)	180 mm.	(*)



N
Black

TURN SIGNALS

HI-TECH PARTS

// TECHNICAL INFO TURN SIGNALS CONNECTIONS:

Most of the bikes use bi-metallic relay. Its frequency (which is the one that sets the pace of the turn signals) depend on the amperage circulating through the circuit. When replacing the turn signals from OEM to aftermarket ones which carry a difference power, consequently they vary the amperage circulating through the circuit and that causes a change on the frequency of the turn signals rhythm. If otherwise, the motorcycle uses electronic relay (which frequency works independently from the amperage circulating through the circuit) the change of turn signals from OEM to aftermarket, should not affect the frequency of the turn signals rhythm.

· **Note:** we recommend in case of doubt of what type of relay the motorcycle uses, to check the turn signal rhythm after switching from OEM to aftermarket.

If the OEM turn signals are replaced by aftermarket ones that use incandescent bulbs, it is needed to check they use the same power. In case is different, it is needed to replace the turn signals bulbs for other that uses the same power as OEM ones. On our catalog, we have available bulbs of different power.

If the OEM turn signals are replaced by LED ones (of much less power than incandescent bulbs), we have two options to balance the frequency of rhythm:

1. Incorporate a parallel relay in the right circuit and the other on the left circuit. If we replace four turn signals, it is needed to use a resistance Part# 42980.

If otherwise, only two turn signals are replaced (one on each side), it is needed to use a resistance Part# 58730.

The resistance are supplied with a scheme for a parallel connection.

· **Note:** On most of the bikes, the warning function of the bike is disabled if the resistance is used.

2. Identify the intermittence relay of the motorcycle (location and number of pins) and replace for its corresponding from the list supplied.

On most of the bikes, the warning functions works correctly when the relay is replaced.

· **Note:** it can be found on the market some motorcycles that do not have a intermittence relay; obviously, in this case it cannot be replaced. Moreover, if on the blinking function intervenes more than one relay, it is possible that replacing only one relay does not solve the problem.



// RESISTOR SET FOR LEDS TURN SIGNALS AND FLASHER RELAYS

MODEL	REF.	PRICE
RESISTORS SET OF 3'9 /25w FOR LEDS TURN SIGNALS	42980	(*)
RESISTORS SET OF 25w FOR MOTORCYCLES THAT MOUNT REAR LEDS TURN SIGNALS, KEEPING ORIGINAL TURN SIGNALS	58730	(*)
FLASHER RELAY 2 PINS	4823N	(*)
FLASHER RELAY 3 PINS	4822N	(*)
FLASHER RELAY 4 PINS	5180N	(*)
RESISTOR SPEED ADJUSTER FOR SEQUENTIAL TURN SIGNAL	0070N	(*)
LED LAMP AMBER FOR TURN SIGNAL	1625T	(*)



// STAR

HOMOLOGATED

MODEL	REF.	PRICE
LED TURN SIGNAL CARBON LOOK BASE SHORT STEMP/ AMBER LENS + SMOKE LENS + LASER LENS BY PAIR 70x 35 mm. 12V 21W	2548C	(*)
LED TURN SIGNAL CARBON LOOK BASE LONG STEMP/ AMBER LENS + SMOKE LENS+LASER LENS BY PAIR 90 x 35 mm. 12V 21W	2549C	(*)
LED TURN SIGNAL BLACK BASE SHORT STEMP/ AMBER LENS + SMOKE LENS+LASER LENS BY PAIR 70 x 35 mm. 12V 21W	4175N	(*)
LED TURN SIGNAL BLACK BASE LONG STEMP/ AMBER LENS + SMOKE LENS+LASER LENS BY PAIR 90 x 35 mm. 12V 21W	4176N	(*)
AMBER BULB STAR TURN SIGNAL 12v-23w (BOX 10 UNITS)	1622T	(*)
CLEAR BULB STAR TURN SIGNAL 12v-23w (BOX 10 UNITS)	1622W	(*)
AMBER BULB STAR TURN SIGNAL 12v-6w (BOX 10 UNITS)	4596T	(*)
CLEAR BULB STAR TURN SIGNAL 12v-23w (BOX 10 UNITS)	4596W	(*)



// MINI

HOMOLOGATED

MODEL	REF.	PRICE
LED TURN SIGNAL CARBON LOOK BASE SHORT STEMP/ AMBER + SMOKE + LASER LENS 70 x 40 mm. 12V 21W	4042C	(*)
LED TURN SIGNAL CARBON LOOK BASE LONG STEMP/ AMBER + SMOKE + LASER LENS 98 x 40 mm.	4043C	(*)
CLEAR BULB MINI TURN SIGNAL (BOX 10 UNITS) 12v-23w	1622W	(*)
AMBER BULB MINI TURN SIGNAL (BOX 10 UNITS) 12v 23w	1622T	(*)

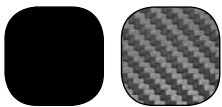

N
Black

C
Carbon Look



TURN SIGNAL



FRONT RUNNING LIGHT



REAR POSITION LIGHT



STOP LIGHT

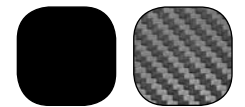

N
Black

C
Carbon Look

CHECK CONNECTIONS TURN SIGNALS ON **PAGE 429**
TO AVOID CONECTIONS PROBLEMS. CHECK THE TECHNICAL SHEET ON **PAGE 430**

TURN SIGNALS

HI-TECH PARTS



// DIAMOND

HOMOLOGATED

MODEL	REF.	PRICE
LED TURN SIGNAL CARBON LOOK BASE SHORT STEM/ AMBER LENS + SMOKE LENS + LASER LENS BY PAIR 64 x 37 mm.	2771T	(*)
AMBER BULB STAR TURN SIGNAL 12v-23w (BOX 10 UNITS)	1622T	(*)
CLEAR BULB STAR TURN SIGNAL 12v-23w (BOX 10 UNITS)	1622W	(*)
AMBER BULB STAR TURN SIGNAL 12v-6w (BOX 10 UNITS)	4596T	(*)
CLEAR BULB STAR TURN SIGNAL 12v- 6w (BOX 10 UNITS)	4596W	(*)

// MASA

HOMOLOGATED

MODEL	REF.	PRICE
LED TURN SIGNAL CARBON LOOK BASE SHORT STEM/ AMBER LENS + SMOKE LENS + LASER LENS BY PAIR 60 x 20 mm 12V 21W	4871N	(*)
LED TURN SIGNAL ANODIZED BASE SHORT STEM/ AMBER LENS + SMOKE LENS + LASER LENS BY PAIR 60 x 20 mm	4870D	(*)
AMBER BULB STAR TURN SIGNAL 12v-23w (BOX 10 UNITS)	1622T	(*)
CLEAR BULB STAR TURN SIGNAL 12v-23w (BOX 10 UNITS).	1622W	(*)
AMBER BULB STAR TURN SIGNAL 12v-23w (BOX 10 UNITS)	4596T	(*)
CLEAR BULB STAR TURN SIGNAL (BOX 10 UNITS)	4596W	(*)

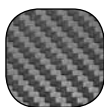

C
Carbon Look



TURN SIGNAL



FRONT RUNNING LIGHT



REAR POSITION LIGHT



STOP LIGHT



N
Black



D
Anodized

CHECK CONNECTIONS TURN SIGNALS ON **PAGE 429**
TO AVOID CONNECTIONS PROBLEMS. CHECK THE TECHNICAL SHEET ON **PAGE 430**



// EYE

HOMOLOGATED

MODEL	REF.	PRICE
BLACK BASE/ CLEAR LENS BY PAIR 68 x 30 mm. 12V 6W	6475N	(*)

// TIP

HOMOLOGATED

MODEL	REF.	PRICE
BLACK BASE/ AMBER LENS BY PAIR 68 x 30 mm. 12V 21W	6476N	(*)
AMBER BULB STAR TURN SIGNAL 12v-23w (BOX 10 UNITS)	1622T	(*)
CLEAR BULB STAR TURN SIGNAL 12v-23w (BOX 10 UNITS).	1622W	(*)
AMBER BULB STAR TURN SIGNAL 12v-23w (BOX 10 UNITS)	4596T	(*)
CLEAR BULB STAR TURN SIGNAL 12v-23w (BOX 10 UNITS).	4596W	(*)



N
Black



TURN SIGNAL



FRONT RUNNING LIGHT



REAR POSITION LIGHT



STOP LIGHT



N
Black

CHECK CONNECTIONS TURN SIGNALS ON **PAGE 429**
TO AVOID CONNECTIONS PROBLEMS. CHECK THE TECHNICAL SHEET ON **PAGE 430**

REAR LIGHTS

HI-TECH PARTS



// OVAL

HOMOLOGATED

	MODEL	REF.	PRICE
1	SMILE - BRAKE REAR LIGHT CLEAR LENS W/LED WITH LICENSE LIGHT 110 x 25 mm. 12V 1W/1W	1359W	(*)
2	LIB - BRAKE REAR LIGHT CLEAR LENS W/LED WITH LICENSE LIGHT 100 x 30 mm.	4818N	(*)
3	BRAKE REAR LIGHT CLEAR LENS W/LED WITH LICENSE LIGHT 90 x 20 mm.	6072W	(*)
4	BRAKE REAR LIGHT CLEAR LENS W/LED WITH LICENSE LIGHT 85 x 20 mm.	6073W	(*)
5	SMILE II - BRAKE REAR LIGHT CLEAR LENS W/LED WITH LICENSE LIGHT 83 x 20 mm. 12V 0,1W/0,9W	6493W	(*)
6	SHARK - BRAKE REAR LIGHT CLEAR LENS W/LED WITH LICENSE LIGHT 83 x 20 mm. 12V 1W/1W	4605W	(*)
7	SHARK2 - BRAKE REAR LIGHT CLEAR LENS W/LED WITH LICENSE LIGHT 83 x 20 mm.	8635W	(*)
8	FURK - BRAKE REAR LIGHT CLEAR LENS W/LED WITH LICENSE LIGHT 40 x 40 mm. ADJUSTABLE INCLINATION	9150N	(*)
9	NOUSE - BRAKE REAR LIGHT CLEAR LENS W/LED WITH LICENSE LIGHT 100 x 40 mm. 12V 0,7W/1,4W	9313N	(*)

1



2



// ELONGATED

	MODEL	REF.	PRICE
1	BRAKE REAR LIGHT W/LEDS 150 x 20 mm.	(*) 0959R	(*)
2	TT - BRAKE REAR LIGHT W/LEDS 75 x 15 mm. HOMOLOGATED	4602R	(*)

(*) These models cannot be homologated, because do not fulfill the prescriptions of the communitarian directive, their use limited for fairs exclusively, closed exhibitions and circuits.



// WITH PLASTIC BASE

HOMOLOGATED

	MODEL	REF.	PRICE
	LED TAILLIGHT CLEAR LENS WITH TRANSPARENT SQUARE 12V 1W/1W	4312N	(*)

1



2



// LIGHTS

	MODEL	REF.	PRICE
1	LED LIGHTS HOMOLOGATED 11W HIGH / 9W LOW / 4W POS COLOR BLACK	1944N	(*)
2	OPTIC AND LAMP H3 55w-12v HIGH BEAM	3448N	(*)
2	OPTIC AND LAMP H3 55w-12v LOW BEAM	3449N	(*)

(*) Check price with your distributor.

IMPORTANT: Indicate code color after part#. Example: 0973A.

STAND SUPPORTS

HI-TECH PARTS



MODEL	REF.	N
STAND SUPPORT OFF-ROAD BASIC	6289N	(*)

Height on the lower position 310 mm. Height on the highest position 400 mm.



MODEL	REF.	N
STAND SUPPORT OFF-ROAD HYDRAULIC	6290N	(*)

Height on the lower position 300 mm. Height on the highest position 410 mm.



MODEL	REF.	N
BASE PARK&MOVE FOR CENTERSTAND	9974N	(*)



MODEL	REF.	N
STAND WHEEL LOCK 17" TO 21"	6071N	(*)



MODEL	REF.	N
REAR STAND FOR TWIN SWING ARMS	4322N	(*)

Include pair adaptors for spool and pair of pads for swing arm.



MODEL	REF.	N
FRONT STAND	4348N	(*)

SPARES	REF.	P
SET OF HOOKS FOR THE REAR STAND IN SILVER	5333P	(*)
ACCESSORIES FOR SWING ARM REAR STAND	4349P	(*)



MODEL	REF.	N
FRONT HEAD STAND. INCLUDE AXIS: 13 mm., 15 mm., 16,5 mm., 17 mm., 18 mm., 27mm.	7310N	(*)



MODEL	REF.	N
REAR STAND FOR SINGLE SWING ARM TRANSMISSION LEFT SIDE, AXIS INCLUDED. (1)	CHECK WEB	
REAR STAND FOR SINGLE SWING ARM TRANSMISSION RIGHT SIDE, AXIS INCLUDED.	CHECK WEB	

SPARE PARTS STAND	REF.	N
REAR STAND FOR SINGLE SWING ARM TRANSMISSION LEFT SIDE	5332N	(*)
REAR STAND FOR SINGLE SWING ARM TRANSMISSION RIGHT SIDE	5849N	(*)

AXIS SPARE	Ø DIAMETER	REF.	N
BMW	53 mm.	5518D	(*)
BMW	30,5 mm.	5557D	(*)
DUCATI	25,8 mm.	5513D	(*)
DUCATI	38,5 mm.	5897D	(*)
DUCATI	40,7 mm.	5517D	(*)
MV GUSTA	40,7 mm.	5517D	(*)
MV GUSTA	42,5 mm	7479D	(*)
HONDA	28,4 mm.	5515D	(*)
TRIUMPH	27,4 mm.	5516D	(*)
KTM	27,4 mm.	5516D	(*)

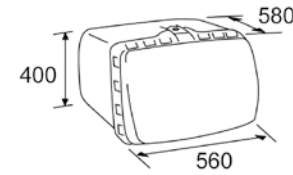
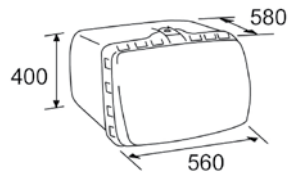

// MEGA BOX WITH LOCK

MODEL	REF.	MATERIAL	R N B
UNIVERSAL	2328	POLYPROPYLENE	(*)

// MEGA BOX LOCK WITHOUT KEY

MODEL	REF.	MATERIAL	R N B
UNIVERSAL	3108	POLYPROPYLENE	(*)
SPARE LOCK WITHOUT KEY	3092		(*)

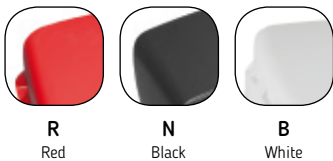

(*) Check price with your distributor.

IMPORTANT: Indicate code color after part#. Example: 0973A.

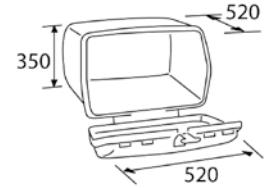
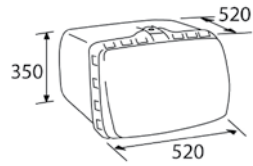

// MAXI BOX WITH LOCK

MODEL	REF.	MATERIAL	R	N	B
UNIVERSAL	0468	POLYPROPYLENE	(*)		
TRAY KIT (OPTIONAL)	1886N	ABS	(*)		
SPARE LOCK	7548N		(*)		
METALLIC BASE	9329N		(*)		
SQUARE HINGE	9851N		(*)		

// MAXI BOX WITH HANDLE

MODEL	REF.	MATERIAL	R	N	B
UNIVERSAL	1126	POLYPROPYLENE	(*)		
TRAY KIT (OPTIONAL)	1886N	ABS	(*)		
SPARE LOCK	3601N		(*)		
METALLIC BASE	9329N		(*)		
SQUARE HINGE	9851N		(*)		

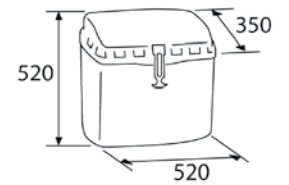
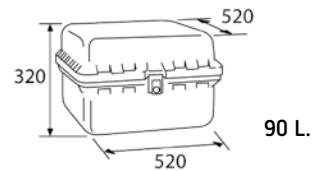
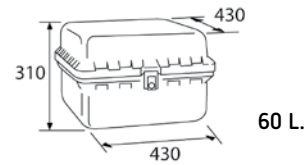

// BIG BOX

MODEL	REF.	MATERIAL	R	N	B
UNIVERSAL 60L.	0390	POLYPROPYLENE	(*)		
UNIVERSAL 90L.	0713	POLYPROPYLENE	(*)		
SPARE LOCK	3601N		(*)		
SPARE SIDE LOCK	9329N		(*)		

// MAXI BOX

MODEL	REF.	MATERIAL	R	N	B
UNIVERSAL WITH HANDLE	1126	POLYPROPYLENE	(*)		
UNIVERSAL WITH KEY	0468	POLYPROPYLENE	(*)		
SPARE HANDLER	3601N		(*)		
SPARE LOCK	7548N		(*)		
METALLIC BASE	9329N		(*)		
SQUARE HINGE	9851N		(*)		



// TERMIC BAG

MODEL	REF.	R
TERMIC BAG 45 x 45 x 24 cm.	9250	(*)

// ISOTERMIC BAG

MODEL	REF.	R
ISOTERMIC BAG 45 x 45 x 20 cm.	9251	(*)



R
Red

(*) Check price with your distributor.

IMPORTANT: Indicate code color after part#. Example: 0973A.

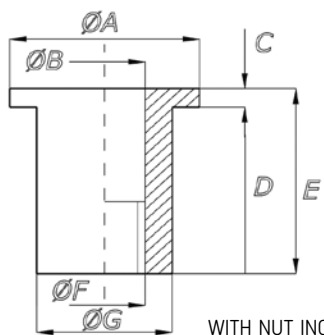

WITH NUT INCORPORATED (25 UNITS IN SAC)

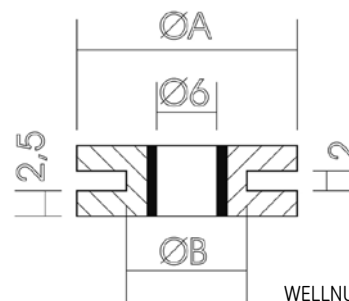

WELLNUTS (25 UNITS IN SAC)

// WELLNUTS

AxBxCxDxExG	REF.	PRICE
14 x 6 x 1,5 x 13,5 x 15 x 10 M5	0714N	(*)
15 x 7 x 1,5 x 13,5 x 15 x 12,5 M6	0715N	(*)
14 x 5 x 1,5 x 11,5 x 13 x 10 M4	1887N	(*)

// WELLNUTS

AxBxCxDxExG	REF.	PRICE
22 x 12	1888N	(*)



// SPIRAL TUBE

MODEL	REF.	PRICE
ROLL OF 10 METERS	0892G	(*)
ROLL OF 10 METERS	0892L	(*)
ROLL OF 10 METERS	0892T	(*)

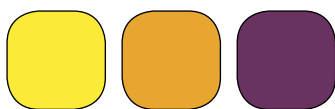

G Yellow
T Orange
L Violet

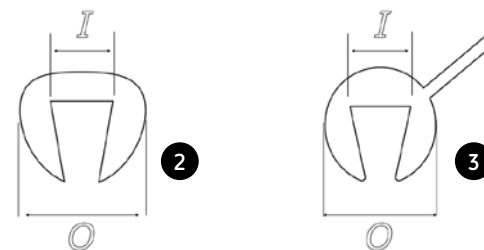

// TRIM-EDGING

Ø x I	COLOR	REF.	ROLL	PRICE
6,2 x 2,6 (2)	TRANSPARENT	0900W	250 mts.	(*)
6,2 x 2,6 (2)	SMOKE	0900H	250 mts.	(*)
6,2 x 2,6 (2)	TRANSPARENT	5843W	2 mts.	(*)
6,2 x 2,6 (2)	SMOKE	5843H	2 mts.	(*)
6,2 x 3,6 (2)	TRANSPARENT	4303W	200 mts.	(*)
6,2 x 3,6 (3)	SMOKE	4748H	200 mts.	(*)
8 x 5 (2)	BLACK	5589N	50 mts.	(*)
3 x 1,5 (2)	BLACK	5590N	50 mts.	(*)
6 x 3 (2)	BLACK WITH ADHESIVE	0088N	25 mts.	(*)



N Black
H Smoke



// SCREEN SCREWS

MODEL	REF.	PRICE
BLISTER 8 SCREWS M5 WITH NUTS	0956	(*)
BLISTER 8 SCREWS M5 WITH WELLNUTS	0957	(*)

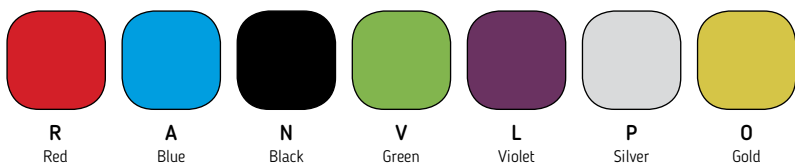

(*) Check price with your distributor.

IMPORTANT: Indicate code color after part#. Example: 0973A.



// ANODIZED SCREWS KIT

MODEL	REF.	R V A N L G P
BLISTER 6 ALLEN SCREWS M5 x 15 mm. (1)	0146	(*)
BLISTER 6 ALLEN SCREWS M5 x 20 mm. (1)	0147	(*)
BLISTER 6 ALLEN SCREWS M5 x 25 mm. (1)	0185	(*)
BLISTER 6 ALLEN SCREWS M6 x 15 mm. (1)	0363	(*)
BLISTER 6 ALLEN SCREWS M6 x 20 mm. (1)	0364	(*)
BLISTER 6 ALLEN SCREWS M6 x 25 mm. (1)	0544	(*)
BLISTER 6 ALLEN SCREWS M6 x 30 mm. (1)	0258	(*)
BLISTER 6 ALLEN SCREWS M6 x 35 mm. (1)	0346	(*)
BLISTER 6 ALLEN SCREWS M6 x 45 mm. (1)	0370	(*)
BLISTER 6 ALLEN SCREWS M6 x 50 mm. (1)	0421	(*)
BLISTER 6 ALLEN SCREWS M6 x 55 mm. (1)	0446	(*)
BLISTER 6 ALLEN SCREWS M8 x 30 mm. (1)	0473	(*)
BLISTER 6 ALLEN SCREWS M8 x 35 mm. (1)	0500	(*)

MODEL	REF.	R V A N L G P
BLISTER 6 ALLEN SCREWS M8 x 45 mm. (1)	0516	(*)
BLISTER 6 ALLEN SCREWS M8 x 50 mm. (1)	0524	(*)
BLISTER 6 ALLEN SCREWS M8 x 55 mm. (1)	0540	(*)
BLISTER 6 ALLEN HEAD SCREWS M5 x 15 mm. (2)	0543	(*)
BLISTER 6 ALLEN HEAD SCREWS M5 x 20 mm. (2)	0550	(*)
BLISTER 6 ALLEN HEAD SCREWS M5 x 25 mm. (2)	0610	(*)
BLISTER 6 ALLEN HEAD SCREWS M6 x 15 mm. (2)	0611	(*)
BLISTER 6 ALLEN HEAD SCREWS M5 x 20 mm. (2)	0657	(*)
BLISTER 6 ALLEN HEAD SCREWS M6 x 25 mm. (2)	0689	(*)
BLISTER 6 ALLEN HEAD SCREWS M6 x 30 mm. (2)	3995	(*)
BLISTER 6 LOCK NUTS M5	0735	(*)
BLISTER 6 LOCK NUTS M6	0736	(*)
BLISTER 6 LOCK NUTS M8	0832	(*)
BLISTER 6 NUTS M5	0763	(*)
BLISTER 6 NUTS M6	0764	(*)
BLISTER 6 NUTS M8	0863	(*)
BLISTER 6 ALLEN HEAD IRON THREAD SCREWS M6 x 20 mm. (3)	2542	(*)
BLISTER 6 ALLEN HEAD IRON THREAD SCREWS M6 x 20 mm. (3)	2543	(*)
PLASTIC BOX (#) (LENGTH 300 x HEIGHT 30 x WIDTH 150)	3961W (#)	(*)

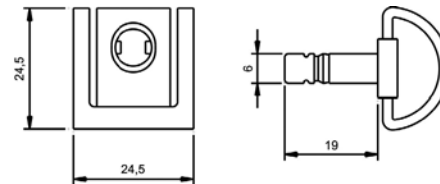

// FAIRING QUICK SCREWS

MODEL	REF.	PRICE
BLISTER 6 FAIRING QUICK SCREWS + BRACKETS	5484D	(*)

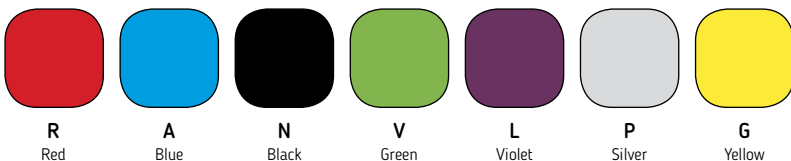

(#) With 32 departments. Delivered 6 screws each of the mostcommon references.

(*) Check price with your distributor.

IMPORTANT: Indicate code color after part#. Example: 0973A.



// SCISSOR LIFT JACK

MODEL	REF.	PRICE
SCISSOR LIFT JACK WITH ADAPTORS	5608R	(*)

DIMENSIONS: 48 x 15 cm.

WEIGHT: 15 kgs.

MAX. LOAD: 500 kgs. Maximal Height: 45 cm.

With four rubber-lined adaptors for supporting the tube frames themselves and two brackets for the adaptors.

ADAPTOR HEIGHTS: 5 cm and 10 cm.

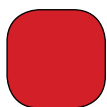

R
Red



// TIRE CHANGER AND LEVER

MODEL	REF.	PRICE
TIRE CHANGER ALUMINIUM RIM 17" C/BLACK	5481N	(*)

(*) Check price with your distributor.

IMPORTANT: Indicate code color after part#. Example: 0973A.



// WHEEL BALANCE STAND

MODEL	REF.	PRICE
WHEEL BALANCE STAND	5482N	(*)
DUCATI ADAPTORS DIMENSIONS 60 x 32 mm.	5974D	(*)



// DIRTY OIL TANK AND BRUSH

MODEL	REF.	PRICE
DIRTY OIL TANK 8L. (600 x 320 x 135 mm.)	5260N	(*)
BRUSH CLEANING CHAIN	5870A	(*)

(*) Check price with your distributor.

IMPORTANT: Indicate code color after part#. Example: 0973A.

WINTER
HI-TECH PARTS



// LEGS COVER SCOOTER

MODEL	REF.	PRICE
UNIVERSAL LEGS COVER RAINCOAT	5508N	(*)



// LEGS COVER

MODEL	REF.	PRICE
UNIVERSAL LEGS COVER RAINCOAT	5485N	(*)



// RAINCOAT MOTORCYCLE COVER

MODEL	REF.	PRICE
SIZE S-L MOTORCYCLES <500 / SCOOTERS	5560P	(*)
SIZE XL-XXL MOTORCYCLES OF 600-1000CC.	5152P	(*)



// LEGS COVER MAXISCOOTER

MODEL	REF.	PRICE
UNIVERSAL LEGS COVER RAINCOAT	9749	(*)



// HEATED GRIPS

MODEL	REF.	PRICE
GRIPS WITH THERMOSTAT FOR HANDLEBARS BY PAIR 22 / 22,2 mm.	5020N	(*)



// HEATED RESISTORS

MODEL	REF.	PRICE
RESISTORS WITH THERMOSTAT FOR GRIPS BY PAIR	5930N	(*)



// SOFT AND SEMI-RIGID HAND GUARDS

MODEL	REF.	PRICE
(1) UNIVERSAL SEMI-RIGID HAND GUARDS	6845N	(*)
(2) UNIVERSAL HAND GUARDS MOTO / SCOOTER	5486N	(*)

(*) Check price with your distributor.

IMPORTANT: Indicate code color after part#. Example: 0973A.

ACCESSORIES

HI-TECH PARTS



// THERMAL GLOVES ANTI-VIBRATION

MODEL	REF.	PRICE
THERMAL GLOVES ANTI-VIBRATION BY PAIR C/BLACK	7778N	(*)
THERMAL GLOVES ANTI-VIBRATION BY PAIR C/RED	7778R	(*)
THERMAL GLOVES ANTI-VIBRATION BY PAIR C/BLUE	7778A	(*)



// SHOE PROTECTOR

MODEL	REF.	PRICE
PROTECTIVE SHIFT LEVER SLEEVE	5248N	(*)



// ADHESIVE FOAM SEAT

MODEL	REF.	PRICE
SHORT ADHESIVE FOAM SET - AxBxC (314 x 312 x 20 mm.)	5212N	(*)
LONG ADHESIVE FOAM SET - AxBxC (344 x 312 x 20 mm.)	5213N	(*)

(*) Check price with your distributor.

IMPORTANT: Indicate code color after part#. Example: 0973A.



// DIGITAL TIRE GAUGE

MODEL	REF.	PRICE
DIGITAL TIRE GAUGE	5401N	(*)



// TIRE REPAIR KIT

MODEL	REF.	PRICE
TIRE REPAIR KIT	5982N	(*)



// KICKSTAND BASE SUPPORT

MODEL	REF.	PRICE
KICKSTAND BASE SUPPORT C/BLACK Ø 80 mm.	6335N	(*)

(*) Check price with your distributor.

IMPORTANT: Indicate code color after part#. Example: 0973A.



// FORK PROTECTOR

MODEL	REF.	PRICE
UNIVERSAL BY PAIR C/CARBON LOOK	1320C	(*)



// GLOVE FOR FRONT BRAKE TANK

MODEL	REF.	PRICE
GLOVE FOR FRONT BRAKE TANK	5208N	(*)

(*) Check price with your distributor.

IMPORTANT: Indicate code color after part#. Example: 0973A.

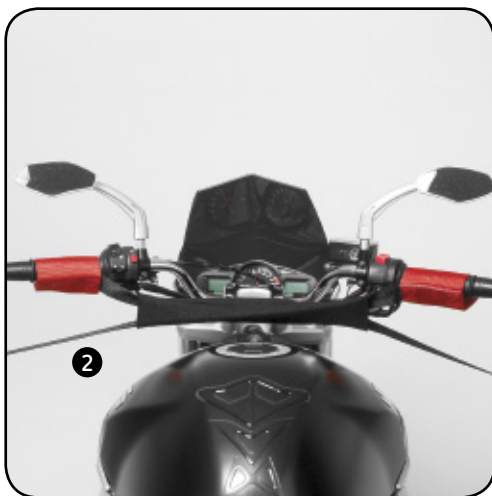

// STRAPS

MODEL	REF.	PRICE
(1) TIE DOWN WITH HOOKS BY PAIR C/BLACK	6274N	(*)
(2) BAR STRAPS BY PAIR C/BLACK	4592N	(*)



// HANDLEBAR BASE CLAMP MIRROR 22 mm.

MODEL	REF.	PRICE
Ø 10 RIGHT THREAD	5216N	(*)
Ø 10 LEFT THREAD	5217N	(*)



// REARVIEW MIRROR MOVE SET

MODEL	REF.	PRICE
UNIVERSAL REAR MIRROR MOVE SET DIAMETER 10 mm. LEFT SIDE	5021N	(*)
UNIVERSAL REAR MIRROR MOVE SET DIAMETER 10 mm. RIGHT SIDE	5106N	(*)
UNIVERSAL REAR MIRROR MOVE SET DIAMETER 10 mm. RIGHT SIDE LEFT THREAD	5107N	(*)

(*) Check price with your distributor.

IMPORTANT: Indicate code color after part#. Example: 0973A.

ACCESSORIES

HI-TECH PARTS



// BLUE TRIANGLE

MODEL	REF.	PRICE
BLUE TRIANGLE LEDS WITH ADHESIVE BASE	(*) 4177A	(*)

(*) These models cannot be homologated, because do not fulfill the prescriptions of the communitarian directive, their use limited for fairs exclusively, closed exhibitions and circuits.



// ELASTIC NETS

MODEL	REF.	PRICE
RED	0788	(*)

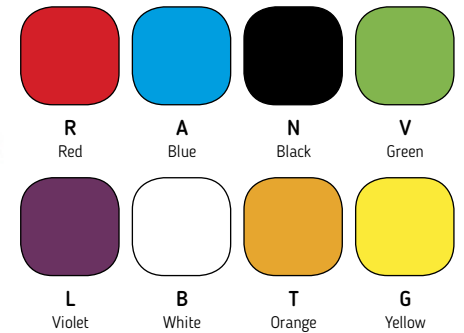

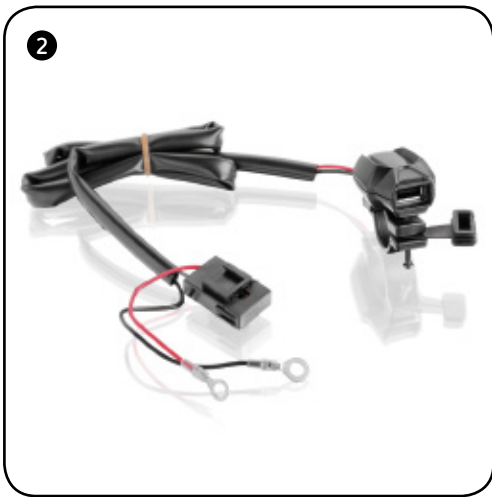

// IN-TAKE CHARGE

MODEL	REF.	PRICE
(1) IN-TAKE CHARGE C/BLACK	6390N	(*)
(2) USB IN-TAKE CHARGE C/BLACK INPUT:12V OUTPUT:2,5A	6840N	(*)



// CELLPHONE CASE

MODEL	REF.	PRICE
(1) CELLPHONE CASE 5' (127mm.) WITH HANDLEBAR CLAMP	2253N	(*)
(2) CELLPHONE CASE 6.3' (160mm.) WITH HANDLEBAR CLAMP	2256N	(*)

(*) Check price with your distributor.

IMPORTANT: Indicate code color after part#. Example: 0973A.



// CATALOG

MODEL	REF.
CATALOG 2019 SPANISH VERSION	9350N
CATALOG 2019 FRENCH VERSION	9351N
CATALOG 2019 ENGLISH VERSION	9352N

// DISPLAY SCREENS

MODEL	REF.	PRICE
DISPLAY SCREENS COLORS	1196R	-

// DISPLAY STRIP

MODEL	REF.	PRICE
STRIP COLOR DISPLAY	9180N	-



// ACRILYC PUIG

MODEL	REF.	PRICE
PUIG ACRILYC	2203B	(*)

// PEN / NOTEBOOK

MODEL	REF.	PRICE
PEN	9347N	(*)
NOTEBOOK	9312N	(*)



// PUIG STICKERS

MODEL	REF.	PRICE
PUIG STICKER BIG 400 mm.	9348N	(*)
PUIG STICKER MEDIUM 135 x 33 mm.	9349N	(*)



// DISPLAY ANODIZED ITEMS

MODEL	REF.	PRICE
DISPLAY LEVER + REAR MIRROR + BAR END + GRIP	9665R	(*)



// HI-TECH PARTS DISPLAY

MODEL	REF.	PRICE
HI-TECH PARTS DISPLAY 854 x 1900 mm.	7324N	(*)

//// MERCHANDISING
HI-TECH PARTS



// BUFF

MODEL	REF.	PRICE
BUFF PUIG	9345N	(*)



// BACKPACK

MODEL	REF.	PRICE
BACKPACK PUIG	9228N	(*)



// KEYCHAINS

MODEL	REF.	PRICE
KEYCHAIN WITH TAPE	9227N	(*)
KEYCHAIN WITH ZIP CLOSURE	8120N	(*)



// CAP

MODEL	REF.	PRICE
CAP HI-TECH PARTS	9346N	(*)



// MEN T-SHIRTS

MODEL	REF.	PRICE
SIZE S	4335N	(*)
SIZE M	4334N	(*)
SIZE L	4333N	(*)
SIZE XL	4332N	(*)
SIZE XXL	4336N	(*)
SIZE XXXL	9343N	(*)
SIZE XXXXL	9344N	(*)

// WOMAN T-SHIRTS

MODEL	REF.	PRICE
SIZE M	5177N	(*)



// JACKET SOFTSHELL

MODEL	REF.	PRICE
SIZE XS	9857N	(*)
SIZE S	9858N	(*)
SIZE M	9859N	(*)
SIZE L	9860N	(*)
SIZE XL	9861N	(*)
SIZE XXL	9862N	(*)
SIZE XXXL	9863N	(*)



// CARPET

MODEL	REF.	
PUIG CARPET 2000 x 800 mm.	6362N	(*)

MANUFACTURED: 100% Nylon, non-slip and water resistant.



// WATCH

MODEL	REF.	PRICE
WATCH PUIG HI-TECH PARTS Ø 30 cm.	9856N	(*)

APPENDIX TABLES

BAR ENDS	P. 460
PLUG-OIL CAPS	P. 482
SPOOLS	P. 486
GRIPS	P. 506
ADAPTORS TO HANDLEBAR REARVIEW MIRRORS	P. 534
ADAPTORS TO ATTACH TO THE FAIRING	P. 560
ADAPTORS TO BAR END REAR MIRRORS	P. 582
WINDSHIELDS FOR SCOOTERS	P. 608

BAR ENDS

HI-TECH PARTS | BAR ENDS MODEL:

2019
MODELS:
www.puig.tv

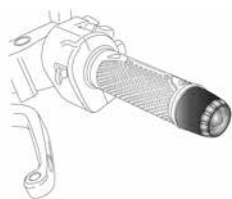

THRUSTER

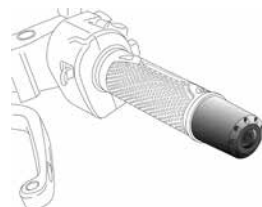

LONG

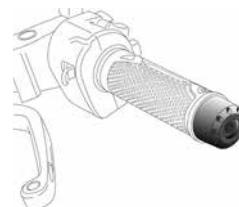

SHORT

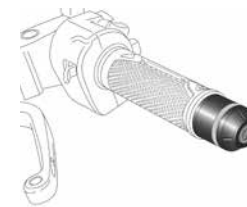

SHORT WITH RING

MODEL	YEAR	BAR ENDS MODEL	REFERENCE	R O A T N P V	C
APRILIA					
SHIVER 750	07' - 16'	LONG	6281	(*)	
SHIVER 750	07' - 16'	SHORT WITH RING	8011	(*)	
SHIVER 900	17' - 18'	LONG	6281	(*)	
SHIVER 900	17' - 18'	SHORT WITH RING	8011	(*)	
TUONO V4 1100 FACTORY	15' - 18'	LONG	7947	(*)	
TUONO V4 1100 FACTORY	15' - 18'	SHORT	7948	(*)	(*)
TUONO V4 1100 FACTORY	15' - 18'	SHORT WITH RING	8015	(*)	
BENELLI					
LEONCINO 500	16' - 18'	THRUSTER	9698+9420	(*)	
BMW					
C600 SPORT	12' - 15'	LONG	6394	(*)	(*)
C600 SPORT	12' - 15'	SHORT	6395	(*)	(*)
C600 SPORT	12' - 15'	SHORT WITH RING	8016	(*)	
C650 GT	12' - 18'	LONG	6394	(*)	(*)
C650 GT	12' - 18'	SHORT	6395	(*)	(*)
C650 GT	12' - 18'	SHORT WITH RING	8016	(*)	
F700 GS	12' - 17'	LONG	6629	(*)	(*)
F700 GS	12' - 17'	SHORT	6641	(*)	(*)
F700 GS	12' - 17'	SHORT WITH RING	8018	(*)	
F800 GT	13' - 18'	LONG	6628	(*)	(*)
F800 GT	13' - 18'	SHORT	6642	(*)	
F800 GT	13' - 18'	SHORT WITH RING	8017	(*)	
F800 GS	13' - 17'	LONG	6629	(*)	(*)
F800 GS	13' - 17'	SHORT	6641	(*)	(*)
F800 GS	13' - 17'	SHORT WITH RING	8018	(*)	
F800 R	09' - 14'	LONG	6277	(*)	
F800 R	09' - 14'	SHORT	6278	(*)	(*)
F800 R	09' - 14'	SHORT WITH RING	8019	(*)	
F800 R	15' - 18'	LONG	6279	(*)	
F800 R	15' - 18'	SHORT	6280	(*)	
F800 R	15' - 18'	SHORT WITH RING	8024	(*)	
G310 GS	17' - 18'	LARGO	8803	(*)	(*)
G310 GS	17' - 18'	SHORT	8804	(*)	(*)
G310 GS	17' - 18'	SHORT WITH RING	8805	(*)	
G310 R	16' - 18'	LONG	8803	(*)	(*)
G310 R	16' - 18'	SHORT	8804	(*)	(*)
G310 R	16' - 18'	SHORT WITH RING	8805	(*)	
R NINE T	14' - 18'	LONG	7129	(*)	

MODEL	YEAR	BAR ENDS MODEL	REFERENCE	R O A T N P V C	C
R NINE T	14' - 18'	SHORT	7130	(*)	
R NINE T	14' - 18'	SHORT WITH RING	8021	(*)	
R NINE T SCRAMBLER	16' - 18'	LONG	7129	(*)	
R NINE T SCRAMBLER	16' - 18'	SHORT	7130	(*)	
R NINE T SCRAMBLER	16' - 18'	SHORT WITH RING	8021	(*)	
R NINE T URBAN G/S	17' - 18'	LONG	7129	(*)	
R NINE T URBAN G/S	17' - 18'	SHORT	7130	(*)	
R NINE T URBAN G/S	17' - 18'	SHORT WITH RING	8021	(*)	
R NINE T PURE	17' - 18'	LONG	7129	(*)	
R NINE T PURE	17' - 18'	SHORT	7130	(*)	
R NINE T PURE	17' - 18'	SHORT WITH RING	8021	(*)	
R NINE T RACER	17' - 18'	LONG	7129	(*)	
R NINE T RACER	17' - 18'	SHORT	7130	(*)	
R NINE T RACER	17' - 18'	SHORT WITH RING	8021	(*)	
R1200 R	15' - 18'	LONG	7953	(*)	(*)
R1200 R	15' - 18'	SHORT	7954	(*)	(*)
R1200 R	15' - 18'	SHORT WITH RING	8022	(*)	
R1200 RS	15' - 18'	LONG	6629	(*)	(*)
R1200 RS	15' - 18'	SHORT	6641	(*)	(*)
R1200 RS	15' - 18'	SHORT WITH RING	8018	(*)	
S1000 R	14' - 18'	SHORT WITH RING	8024	(*)	
S1000 RR	09' - 18'	SHORT WITH RING	8024	(*)	
S1000 XR	15' - 18'	LONG	7953	(*)	(*)
S1000 XR	15' - 18'	SHORT	7954	(*)	(*)
S1000 XR	15' - 18'	SHORT WITH RING	8022	(*)	
DUCATI					
959 PANIGALE	16' - 18'	LONG	5777	(*)	
959 PANIGALE	16' - 18'	SHORT	6203	(*)	
959 PANIGALE	16' - 18'	SHORT WITH RING	8498	(*)	
959 PANIGALE	16' - 18'	THRUSTER	9411+9420	(*)	
PANIGALE V4/S/SPECIALE	18'	LONG	5777	(*)	
PANIGALE V4/S/SPECIALE	18'	SHORT	6203	(*)	
PANIGALE V4/S/SPECIALE	18'	SHORT WITH RING	8498	(*)	
PANIGALE V4/S/SPECIALE	18'	THRUSTER	9411+9420	(*)	
MONSTER 797	17' - 18'	LARGO	5777	(*)	
MONSTER 797	17' - 18'	SHORT	6203	(*)	
MONSTER 797	17' - 18'	SHORT WITH RING	8498	(*)	
MONSTER 797	17' - 18'	THRUSTER	9411+9420	(*)	
MONSTER 821	14' - 18'	LONG	5777	(*)	
MONSTER 821	14' - 18'	SHORT	6203	(*)	
MONSTER 821	14' - 18'	SHORT WITH RING	8498	(*)	
MONSTER 821	14' - 18'	THRUSTER	9411+9420	(*)	
MONSTER 1200 R	16' - 18'	LONG	5777	(*)	

R O A T N P V COLORS: BAR ENDS THRUSTER | REF. 9420 = SET OF CAPS BAR ENDS

R O A T N P V C COLORS: LONG BAR ENDS

R O A T N P V C COLORS: SHORT BAR ENDS

N COLORS: SHORT WITH RINGS BAR ENDS

(*) Check price with your distributor.

IMPORTANT: Indicate code color after part#. Example: 0973A.

BAR ENDS

HI-TECH PARTS | BAR ENDS MODEL:

2019
MODELS:
www.puig.tv

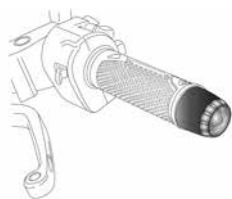

THRUSTER

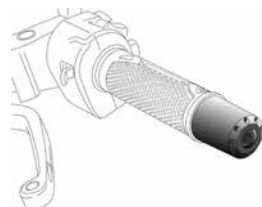

LONG

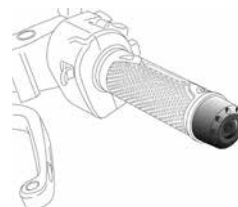

SHORT

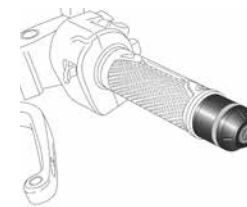

SHORT WITH RING

MODEL	YEAR	BAR ENDS MODEL	REFERENCE	R O A T N P V	C
MONSTER 1200 R	16' - 18'	SHORT	6203	(*)	
MONSTER 1200 R	16' - 18'	SHORT WITH RING	8498	(*)	
MONSTER 1200 R	16' - 18'	THRUSTER	9411+9420	(*)	
MONSTER 1200/S	17' - 18'	LARGO	5777	(*)	
MONSTER 1200/S	17' - 18'	SHORT	6203	(*)	
MONSTER 1200/S	17' - 18'	SHORT WITH RING	8498	(*)	
MONSTER 1200/S	17' - 18'	THRUSTER	9411+9420	(*)	
SCRAMBLER ICON/CLASSIC/FULL THROTTLE	15' - 18'	LONG	5777	(*)	
SCRAMBLER ICON/CLASSIC/FULL THROTTLE	15' - 18'	SHORT	6203	(*)	
SCRAMBLER ICON/CLASSIC/FULL THROTTLE	15' - 18'	SHORT WITH RING	8498	(*)	
SCRAMBLER ICON/CLASSIC/FULL THROTTLE	15' - 18'	THRUSTER	9411+9420	(*)	
SCRAMBLER SIXTY2	16' - 18'	LONG	5777	(*)	
SCRAMBLER SIXTY2	16' - 18'	SHORT	6203	(*)	
SCRAMBLER SIXTY2	16' - 18'	SHORT WITH RING	8498	(*)	
SCRAMBLER SIXTY2	16' - 18'	THRUSTER	9411+9420	(*)	
SCRAMBLER URBAN ENDURO	15' - 16'	LONG	5777	(*)	
SCRAMBLER URBAN ENDURO	15' - 16'	SHORT	6203	(*)	
SCRAMBLER URBAN ENDURO	15' - 16'	SHORT WITH RING	8498	(*)	
SCRAMBLER URBAN ENDURO	15' - 16'	THRUSTER	9411+9420	(*)	
SCRAMBLER FLAT TRACK PRO	16'	LONG	5777	(*)	
SCRAMBLER FLAT TRACK PRO	16'	SHORT	6203	(*)	
SCRAMBLER FLAT TRACK PRO	16'	SHORT WITH RING	8498	(*)	
SCRAMBLER FLAT TRACK PRO	16'	THRUSTER	9411+9420	(*)	
SCRAMBLER DESERT SLED	17' - 18'	LARGO	5777	(*)	
SCRAMBLER DESERT SLED	17' - 18'	SHORT	6203	(*)	
SCRAMBLER DESERT SLED	17' - 18'	SHORT WITH RING	8498	(*)	
SCRAMBLER DESERT SLED	17' - 18'	THRUSTER	9411+9420	(*)	
SCRAMBLER 1100	18'	LARGO	5777	(*)	
SCRAMBLER 1100	18'	SHORT	6203	(*)	
SCRAMBLER 1100	18'	SHORT WITH RING	8498	(*)	
SCRAMBLER 1100	18'	THRUSTER	9411+9420	(*)	
SCRAMBLER 1100 SPORT	18'	LARGO	5777	(*)	
SCRAMBLER 1100 SPORT	18'	SHORT	6203	(*)	
SCRAMBLER 1100 SPORT	18'	SHORT WITH RING	8498	(*)	
SCRAMBLER 1100 SPORT	18'	THRUSTER	9411+9420	(*)	
SCRAMBLER 1100 SPECIAL	18'	LARGO	5777	(*)	
SCRAMBLER 1100 SPECIAL	18'	SHORT	6203	(*)	
SCRAMBLER 1100 SPECIAL	18'	SHORT WITH RING	8498	(*)	
SCRAMBLER 1100 SPECIAL	18'	THRUSTER	9411+9420	(*)	

MODEL	YEAR	BAR ENDS MODEL	REFERENCE	R O A T N P V	C
SUPERSPORT 939/S	17' - 18'	LARGO	5777	(*)	
SUPERSPORT 939/S	17' - 18'	SHORT	6203	(*)	
SUPERSPORT 939/S	17' - 18'	SHORT WITH RING	8498	(*)	
SUPERSPORT 939/S	17' - 18'	THRUSTER	9411+9420	(*)	
X DIAVEL	16' - 18'	LONG	5777	(*)	
X DIAVEL	16' - 18'	SHORT	6203	(*)	
X DIAVEL	16' - 18'	SHORT WITH RING	8498	(*)	
X DIAVEL	16' - 18'	THRUSTER	9411+9420	(*)	
HONDA					
CB125F	15' - 18'	LONG	5777	(*)	
CB125F	15' - 18'	SHORT	6203	(*)	
CB125F	15' - 18'	SHORT WITH RING	8498	(*)	
CB125F	15' - 18'	THRUSTER	9411+9420	(*)	
CB125R NEO SPORTS CAFE	18'	LONG	5777	(*)	
CB125R NEO SPORTS CAFE	18'	SHORT	6203	(*)	
CB125R NEO SPORTS CAFE	18'	SHORT WITH RING	8498	(*)	
CB125R NEO SPORTS CAFE	18'	THRUSTER	9411+9420	(*)	
CB300R NEO SPORTS CAFE	18'	LONG	6631	(*)	(*)
CB300R NEO SPORTS CAFE	18'	SHORT	6643	(*)	(*)
CB300R NEO SPORTS CAFE	18'	SHORT WITH RING	8035	(*)	
CB300R NEO SPORTS CAFE	18'	THRUSTER	9878+9420	(*)	
CB1000R NEO SPORTS CAFE	18'	LONG	5619	(*)	
CB1000R NEO SPORTS CAFE	18'	SHORT	6181	(*)	
CB1000R NEO SPORTS CAFE	18'	SHORT WITH RING	8034	(*)	
CB1000R NEO SPORTS CAFE	18'	THRUSTER	9410+9420	(*)	
CB500	93' - 04'	LONG	5619	(*)	
CB500	93' - 04'	SHORT	6181	(*)	
CB500	93' - 04'	SHORT WITH RING	8034	(*)	
CB500	93' - 04'	THRUSTER	9410+9420	(*)	
CB500F	13' - 18'	LONG	6631	(*)	(*)
CB500F	13' - 18'	SHORT	6643	(*)	(*)
CB500F	13' - 18'	SHORT WITH RING	8035	(*)	
CB500F	13' - 18'	THRUSTER	9878+9420	(*)	
CB500X	13' - 18'	LONG	6631	(*)	(*)
CB500X	13' - 18'	SHORT	6643	(*)	(*)
CB500X	13' - 18'	SHORT WITH RING	8035	(*)	
CB500X	13' - 18'	THRUSTER	9878+9420	(*)	
CB600F HORNET	98' - 15'	LONG	5619	(*)	
CB600F HORNET	98' - 15'	SHORT	6181	(*)	
CB600F HORNET	98' - 15'	SHORT WITH RING	8034	(*)	
CB600F HORNET	98' - 15'	THRUSTER	9410+9420	(*)	
CB650F	14' - 18	LONG	6631	(*)	(*)
CB650F	14' - 18	SHORT	6643	(*)	(*)

R O A T N P V COLORS: BAR ENDS THRUSTER | REF. 9420 = SET OF CAPS BAR ENDS

R O A T N P V C COLORS: LONG BAR ENDS

R O A T N P V C COLORS: SHORT BAR ENDS

N COLORS: SHORT WITH RINGS BAR ENDS

(*) Check price with your distributor.

IMPORTANT: Indicate code color after part#. Example: 0973A.

BAR ENDS

HI-TECH PARTS | BAR ENDS MODEL:

2019
MODELS:
www.puig.tv

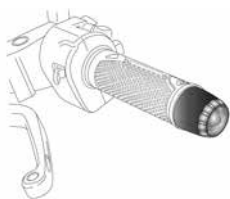

THRUSTER

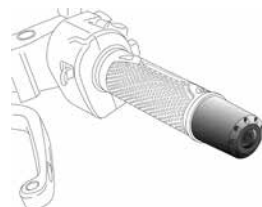

LONG

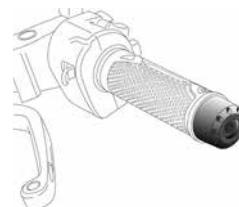

SHORT

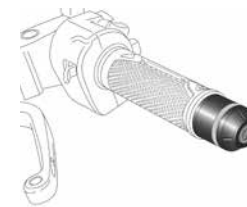

SHORT WITH RING

MODEL	YEAR	BAR ENDS MODEL	REFERENCE	R O A T N P V	C
CB650F	14' - 18	SHORT WITH RING	8035	(*)	
CB650F	14' - 18	THRUSTER	9878+9420	(*)	
CB750	93' - 03'	LONG	5619	(*)	
CB750	93' - 03'	SHORT	6181	(*)	
CB750	93' - 03'	SHORT WITH RING	8034	(*)	
CB750	93' - 03'	THRUSTER	9410+9420	(*)	
CB900F HORNET	02' - 05'	LONG	5619	(*)	
CB900F HORNET	02' - 05'	SHORT	6181	(*)	
CB900F HORNET	02' - 05'	SHORT WITH RING	8034	(*)	
CB900F HORNET	02' - 05'	THRUSTER	9410+9420	(*)	
CB1000R	08' - 16'	LONG	5619	(*)	
CB1000R	08' - 16'	SHORT	6181	(*)	
CB1000R	08' - 16'	SHORT WITH RING	8034	(*)	
CB1000R	08' - 16'	THRUSTER	9410+9420	(*)	
CB1100EX	14' - 18'	LARGO	8837	(*)	(*)
CB1100EX	14' - 18'	SHORT	8838	(*)	(*)
CB1100EX	14' - 18'	SHORT WITH RING	8839	(*)	
CB1100RS	14' - 18'	LARGO	8837	(*)	(*)
CB1100RS	14' - 18'	SHORT	8838	(*)	(*)
CB1100RS	14' - 18'	SHORT WITH RING	8839	(*)	
CB1300	03'	LONG	5619	(*)	
CB1300	03'	SHORT	6181	(*)	
CB1300	03'	SHORT WITH RING	8034	(*)	
CB1300	03'	THRUSTER	9410+9420	(*)	
CBF250	04' - 16'	LONG	5619	(*)	
CBF250	04' - 16'	SHORT	6181	(*)	
CBF250	04' - 16'	SHORT WITH RING	8034	(*)	
CBF250	04' - 16'	THRUSTER	9410+9420	(*)	
CBF500	04' - 07'	LONG	5619	(*)	
CBF500	04' - 07'	SHORT	6181	(*)	
CBF500	04' - 07'	SHORT WITH RING	8034	(*)	
CBF500	04' - 07'	THRUSTER	9410+9420	(*)	
CBF600	04' - 14'	LONG	5619	(*)	
CBF600	04' - 14'	SHORT	6181	(*)	
CBF600	04' - 14'	SHORT WITH RING	8034	(*)	
CBF600	04' - 14'	THRUSTER	9410+9420	(*)	
CBF600S	08' - 14'	LONG	5619	(*)	
CBF600S	08' - 14'	SHORT	6181	(*)	
CBF600S	08' - 14'	SHORT WITH RING	8034	(*)	

MODEL	YEAR	BAR ENDS MODEL	REFERENCE	R O A T N P V	C
CBF600S	08' - 14'	THRUSTER	9410+9420	(*)	
CBF1000	06' - 11'	LONG	5619	(*)	
CBF1000	06' - 11'	SHORT	6181	(*)	
CBF1000	06' - 11'	SHORT WITH RING	8034	(*)	
CBF1000	06' - 11'	THRUSTER	9410+9420	(*)	
CBR600F	99' - 07'	LONG	5619	(*)	
CBR600F	99' - 07'	SHORT	6181	(*)	
CBR600F	99' - 07'	SHORT WITH RING	8034	(*)	
CBR600F	99' - 07'	THRUSTER	9410+9420	(*)	
CBR600F	11' - 13'	LONG	5619	(*)	
CBR600F	11' - 13'	SHORT	6181	(*)	
CBR600F	11' - 13'	SHORT WITH RING	8034	(*)	
CBR600F	11' - 13'	THRUSTER	9410+9420	(*)	
CBR650F	14' - 18'	LONG	6631	(*)	(*)
CBR650F	14' - 18'	SHORT	6643	(*)	(*)
CBR650F	14' - 18'	SHORT WITH RING	8035	(*)	
CBR650F	14' - 18'	THRUSTER	9878+9420	(*)	
CBR1000F	94' - 00'	LONG	5619	(*)	
CBR1000F	94' - 00'	SHORT	6181	(*)	
CBR1000F	94' - 00'	SHORT WITH RING	8034	(*)	
CBR1000F	94' - 00'	THRUSTER	9410+9420	(*)	
CBR125R	11' - 16'	LONG	5619	(*)	
CBR125R	11' - 16'	SHORT	6181	(*)	
CBR125R	11' - 16'	SHORT WITH RING	8034	(*)	
CBR125R	11' - 16'	THRUSTER	9410+9420	(*)	
CBR250R	11' - 15'	LONG	5619	(*)	
CBR250R	11' - 15'	SHORT	6181	(*)	
CBR250R	11' - 15'	SHORT WITH RING	8034	(*)	
CBR250R	11' - 15'	THRUSTER	9410+9420	(*)	
CBR500R	13' - 18'	LONG	6631	(*)	(*)
CBR500R	13' - 18'	SHORT	6643	(*)	(*)
CBR500R	13' - 18'	SHORT WITH RING	8035	(*)	
CBR500R	13' - 18'	THRUSTER	9878+9420	(*)	
CBR600RR	03' - 16'	LONG	5619	(*)	
CBR600RR	03' - 16'	SHORT	6181	(*)	
CBR600RR	03' - 16'	SHORT WITH RING	8034	(*)	
CBR600RR	03' - 16'	THRUSTER	9410+9420	(*)	
CBR900RR FIREBLADE	00' - 03'	LONG	5619	(*)	
CBR900RR FIREBLADE	00' - 03'	SHORT	6181	(*)	
CBR900RR FIREBLADE	00' - 03'	SHORT WITH RING	8034	(*)	
CBR900RR FIREBLADE	00' - 03'	THRUSTER	9410+9420	(*)	
CBR1000RR FIREBLADE	04' - 13'	LONG	5619	(*)	
CBR1000RR FIREBLADE	04' - 13'	SHORT	6181	(*)	

R O A T N P V COLORS: BAR ENDS THRUSTER | REF. 9420 = SET OF CAPS BAR ENDS

R O A T N P V C COLORS: LONG BAR ENDS

R O A T N P V C COLORS: SHORT BAR ENDS

N COLORS: SHORT WITH RINGS BAR ENDS

(*) Check price with your distributor.

IMPORTANT: Indicate code color after part#. Example: 0973A.

BAR ENDS

HI-TECH PARTS | BAR ENDS MODEL:

2019
MODELS:
www.puig.tv

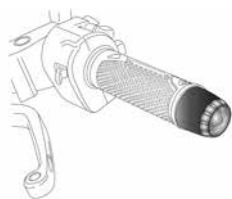

THRUSTER

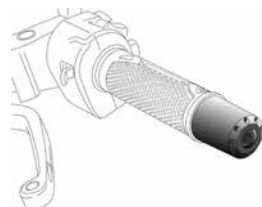

LONG

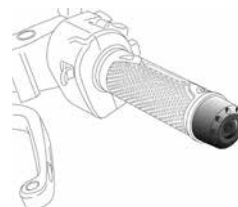

SHORT

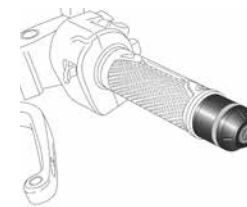

SHORT WITH RING

MODEL	YEAR	BAR ENDS MODEL	REFERENCE	R O A T N P V	C
CBR1000RR FIREBLADE	04' - 13'	SHORT WITH RING	8034	(*)	
CBR1000RR FIREBLADE	04' - 13'	THRUSTER	9410+9420	(*)	
CBR1000RR FIREBLADE /SP	14' - 16'	LONG	5619	(*)	
CBR1000RR FIREBLADE /SP	14' - 16'	SHORT	6181	(*)	
CBR1000RR FIREBLADE /SP	14' - 16'	SHORT WITH RING	8034	(*)	
CBR1000RR FIREBLADE /SP	14' - 16'	THRUSTER	9410+9420	(*)	
CBR1000RR FIREBLADE/SP/SP2	17' - 18'	LARGO	5619	(*)	
CBR1000RR FIREBLADE/SP/SP2	17' - 18'	SHORT	6181	(*)	
CBR1000RR FIREBLADE/SP/SP2	17' - 18'	SHORT WITH RING	8034	(*)	
CBR1000RR FIREBLADE/SP/SP2	17' - 18'	THRUSTER	9410+9420	(*)	
CBR1100XX BLACKBIRD	97' - 07'	LONG	5619	(*)	
CBR1100XX BLACKBIRD	97' - 07'	SHORT	6181	(*)	
CBR1100XX BLACKBIRD	97' - 07'	SHORT WITH RING	8034	(*)	
CBR1100XX BLACKBIRD	97' - 07'	THRUSTER	9410+9420	(*)	
CROSSRUNNER	15' - 18'	LONG	5777	(*)	
CROSSRUNNER	15' - 18'	SHORT	6203	(*)	
CROSSRUNNER	15' - 18'	SHORT WITH RING	8498	(*)	
CROSSRUNNER	15' - 18'	THRUSTER	9411+9420	(*)	
INTEGRA 700	12' - 13'	LONG	5619	(*)	
INTEGRA 700	12' - 13'	SHORT	6181	(*)	
INTEGRA 700	12' - 13'	SHORT WITH RING	8034	(*)	
INTEGRA 700	12' - 13'	THRUSTER	9410+9420	(*)	
INTEGRA 750	14' - 15'	LONG	5619	(*)	
INTEGRA 750	14' - 15'	SHORT	6181	(*)	
INTEGRA 750	14' - 15'	SHORT WITH RING	8034	(*)	
INTEGRA 750	14' - 15'	THRUSTER	9410+9420	(*)	
INTEGRA 750	16' - 18'	LONG	8837	(*)	(*)
INTEGRA 750	16' - 18'	SHORT	8838	(*)	(*)
INTEGRA 750	16' - 18'	SHORT WITH RING	8839	(*)	
NC700S/X	12' - 13'	LONG	5619	(*)	
NC700S/X	12' - 13'	SHORT	6181	(*)	
NC700S/X	12' - 13'	SHORT WITH RING	8034	(*)	
NC700S/X	12' - 13'	THRUSTER	9410+9420	(*)	
NC750S/X	14' - 15'	LONG	5619	(*)	
NC750S/X	14' - 15'	SHORT	6181	(*)	
NC750S/X	14' - 15'	SHORT WITH RING	8034	(*)	
NC750S/X	14' - 15'	THRUSTER	9410+9420	(*)	
NC750S/X	16' - 18'	LONG	8837	(*)	(*)
NC750S/X	16' - 18'	SHORT	8838	(*)	(*)

MODEL	YEAR	BAR ENDS MODEL	REFERENCE	R O A T N P V	C
NC750S/X	16' - 18'	SHORT WITH RING	8839	(*)	
MSX125	14' - 18'	LONG	6819	(*)	(*)
MSX125	14' - 18'	SHORT	6820	(*)	
MSX125	14' - 18'	SHORT WITH RING	8067	(*)	
PCX 125	10' - 18'	LONG	6819	(*)	(*)
PCX 125	10' - 18'	SHORT	6820	(*)	
PCX 125	10' - 18'	SHORT WITH RING	8067	(*)	
VFR800F	98' - 01'	LONG	5619	(*)	
VFR800F	98' - 01'	SHORT	6181	(*)	
VFR800F	98' - 01'	SHORT WITH RING	8034	(*)	
VFR800F	98' - 01'	THRUSTER	9410+9420	(*)	
VFR800F	14' - 18'	SHORT WITH RING	8070	(*)	
VFR1200F	10' - 16'	LONG	5619	(*)	
VFR1200F	10' - 16'	SHORT	6181	(*)	
VFR1200F	10' - 16'	SHORT WITH RING	8034	(*)	
VFR1200F	10' - 16'	THRUSTER	9410+9420	(*)	
VTR1000F FIRE STORM	97' - 07'	LONG	5619	(*)	
VTR1000F FIRE STORM	97' - 07'	SHORT	6181	(*)	
VTR1000F FIRE STORM	97' - 07'	SHORT WITH RING	8034	(*)	
VTR1000F FIRE STORM	97' - 07'	THRUSTER	9410+9420	(*)	
X-ADV	17' - 18'	LARGO	CHECK WEB		
X-ADV	17' - 18'	SHORT	CHECK WEB		
X-ADV	17' - 18'	SHORT WITH RING	CHECK WEB		
X-ELEVEN	99' - 03'	LONG	5619	(*)	
X-ELEVEN	99' - 03'	SHORT	6181	(*)	
X-ELEVEN	99' - 03'	SHORT WITH RING	8034	(*)	
X-ELEVEN	99' - 03'	THRUSTER	9410+9420	(*)	
KAWASAKI					
ER-6N	05' - 16'	LONG	5618	(*)	(*)
ER-6N	05' - 16'	SHORT	6186	(*)	(*)
ER-6N	05' - 16'	SHORT WITH RING	8074	(*)	
ER-6N	05' - 16'	THRUSTER	9409+9420	(*)	
ER-6F	09' - 16'	LONG	5618	(*)	(*)
ER-6F	09' - 16'	SHORT	6186	(*)	(*)
ER-6F	09' - 16'	SHORT WITH RING	8074	(*)	
ER-6F	09' - 16'	THRUSTER	9409+9420	(*)	
NINJA 250R	08' - 12'	LONG	5618	(*)	(*)
NINJA 250R	08' - 12'	SHORT	6186	(*)	(*)
NINJA 250R	08' - 12'	SHORT WITH RING	8074	(*)	
NINJA 250R	08' - 12'	THRUSTER	9409+9420	(*)	
NINJA 250SL	15' - 16'	LONG	5777	(*)	
NINJA 250SL	15' - 16'	SHORT	6203	(*)	
NINJA 250SL	15' - 16'	SHORT WITH RING	8498	(*)	

R O A T N P V COLORS: BAR ENDS THRUSTER | REF. 9420 = SET OF CAPS BAR ENDS

R O A T N P V C COLORS: LONG BAR ENDS

R O A T N P V C COLORS: SHORT BAR ENDS

N COLORS: SHORT WITH RINGS BAR ENDS

(*) Check price with your distributor.

IMPORTANT: Indicate code color after part#. Example: 0973A.

BAR ENDS

HI-TECH PARTS | BAR ENDS MODEL:

2019
MODELS:
www.puig.tv

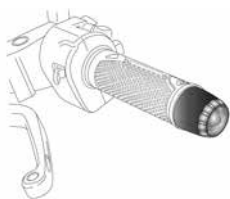

THRUSTER

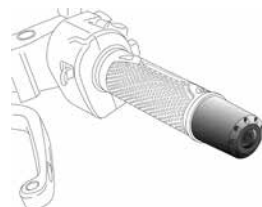

LONG

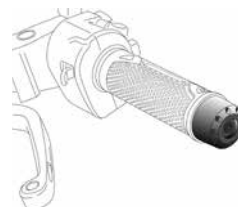

SHORT



SHORT WITH RING

MODEL	YEAR	BAR ENDS MODEL	REFERENCE	R O A T N P V	C
NINJA 250SL	15' - 16'	THRUSTER	9411+9420	(*)	
NINJA 300	13' - 17'	LONG	5618	(*)	(*)
NINJA 300	13' - 17'	SHORT	6186	(*)	(*)
NINJA 300	13' - 17'	SHORT WITH RING	8074	(*)	
NINJA 300	13' - 17'	THRUSTER	9409+9420	(*)	
NINJA 400	18'	LONG	5618	(*)	(*)
NINJA 400	18'	SHORT	6186	(*)	(*)
NINJA 400	18'	SHORT WITH RING	8074	(*)	
NINJA 400	18'	THRUSTER	9409+9420	(*)	
NINJA 650	17' - 18'	LARGO	9357	(*)	
NINJA 650	17' - 18'	SHORT	9358	(*)	
NINJA 650	17' - 18'	SHORT WITH RING	9359	(*)	
NINJA 650	17' - 18'	THRUSTER	9877+9420	(*)	
NINJA H2 SX	18'	LARGO	9357	(*)	
NINJA H2 SX	18'	SHORT	9358	(*)	
NINJA H2 SX	18'	SHORT WITH RING	9359	(*)	
NINJA H2 SX	18'	THRUSTER	9877+9420	(*)	
VERSYS-X 300	17' - 18'	LARGO	9357	(*)	
VERSYS-X 300	17' - 18'	SHORT	9358	(*)	
VERSYS-X 300	17' - 18'	SHORT WITH RING	9359	(*)	
VERSYS-X 300	17' - 18'	THRUSTER	9877+9420	(*)	
VERSYS 650	07' - 18'	LONG	5618	(*)	(*)
VERSYS 650	07' - 18'	SHORT	6186	(*)	(*)
VERSYS 650	07' - 18'	SHORT WITH RING	8074	(*)	
VERSYS 650	07' - 18'	THRUSTER	9409+9420	(*)	
VERSYS 1000	12' - 18'	LONG	5618	(*)	(*)
VERSYS 1000	12' - 18'	SHORT	6186	(*)	(*)
VERSYS 1000	12' - 18'	SHORT WITH RING	8074	(*)	
VERSYS 1000	12' - 18'	THRUSTER	9409+9420	(*)	
VULCAN S	15' - 18'	LARGO	5618	(*)	(*)
VULCAN S	15' - 18'	SHORT	6186	(*)	(*)
VULCAN S	15' - 18'	SHORT WITH RING	8074	(*)	
VULCAN S	15' - 18'	THRUSTER	9409+9420	(*)	
VULCAN S CAFE	17' - 18'	LARGO	5618	(*)	(*)
VULCAN S CAFE	17' - 18'	SHORT	6186	(*)	(*)
VULCAN S CAFE	17' - 18'	SHORT WITH RING	8074	(*)	
VULCAN S CAFE	17' - 18'	THRUSTER	9409+9420	(*)	
Z125	17' - 18'	LARGO	5777	(*)	
Z125	17' - 18'	SHORT	6203	(*)	

MODEL	YEAR	BAR ENDS MODEL	REFERENCE	R O A T N P V C	C
Z125	17' - 18'	SHORT WITH RING	8498	(*)	
Z125	17' - 18'	THRUSTER	9411+9420	(*)	
Z250SL	15' - 16'	LONG	5777	(*)	
Z250SL	15' - 16'	SHORT	6203	(*)	
Z250SL	15' - 16'	SHORT WITH RING	8498	(*)	
Z250SL	15' - 16'	THRUSTER	9411+9420	(*)	
Z300	15' - 17'	LONG	5618	(*)	(*)
Z300	15' - 17'	SHORT	6186	(*)	(*)
Z300	15' - 17'	SHORT WITH RING	8074	(*)	
Z300	15' - 17'	THRUSTER	9409+9420	(*)	
Z750	04' - 12'	LONG	5618	(*)	(*)
Z750	04' - 12'	SHORT	6186	(*)	(*)
Z750	04' - 12'	SHORT WITH RING	8074	(*)	
Z750	04' - 12'	THRUSTER	9409+9420	(*)	
Z750R	11 - 12'	LONG	5618	(*)	(*)
Z750R	11 - 12'	SHORT	6186	(*)	(*)
Z750R	11 - 12'	SHORT WITH RING	8074	(*)	
Z750R	11 - 12'	THRUSTER	9409+9420	(*)	
Z650	17' - 18'	LARGO	9357	(*)	
Z650	17' - 18'	SHORT	9358	(*)	
Z650	17' - 18'	SHORT WITH RING	9359	(*)	
Z650	17' - 18'	THRUSTER	9877+9420	(*)	
Z800/E	13' - 16'	LONG	5618	(*)	(*)
Z800/E	13' - 16'	SHORT	6186	(*)	(*)
Z800/E	13' - 16'	SHORT WITH RING	8074	(*)	
Z800/E	13' - 16'	THRUSTER	9409+9420	(*)	
Z900	17' - 18'	LARGO	5618	(*)	(*)
Z900	17' - 18'	SHORT	6186	(*)	(*)
Z900	17' - 18'	SHORT WITH RING	8074	(*)	
Z900	17' - 18'	THRUSTER	9409+9420	(*)	
Z900RS	18'	LARGO	5618	(*)	(*)
Z900RS	18'	SHORT	6186	(*)	(*)
Z900RS	18'	SHORT WITH RING	8074	(*)	
Z900RS	18'	THRUSTER	9409+9420	(*)	
Z1000	03' - 18'	LONG	5618	(*)	(*)
Z1000	03' - 18'	SHORT	6186	(*)	(*)
Z1000	03' - 18'	SHORT WITH RING	8074	(*)	
Z1000	03' - 18'	THRUSTER	9409+9420	(*)	
Z1000R	17' - 18'	LONG	5618	(*)	(*)
Z1000R	17' - 18'	SHORT	6186	(*)	(*)
Z1000R	17' - 18'	SHORT WITH RING	8074	(*)	
Z1000R	17' - 18'	THRUSTER	9409+9420	(*)	
Z1000SX	11' - 18'	LONG	5618	(*)	(*)

- R O A T N P V COLORS: BAR ENDS THRUSTER | REF. 9420 = SET OF CAPS BAR ENDS
- R O A T N P V C COLORS: LONG BAR ENDS
- R O A T N P V C COLORS: SHORT BAR ENDS
- N COLORS: SHORT WITH RINGS BAR ENDS

(*) Check price with your distributor.

IMPORTANT: Indicate code color after part#. Example: 0973A.

BAR ENDS

HI-TECH PARTS | BAR ENDS MODEL:

2019
MODELS:
www.puig.tv

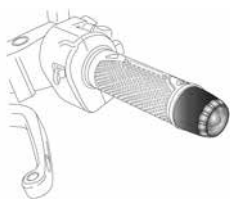

THRUSTER

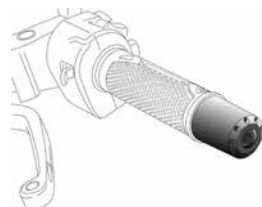

LONG

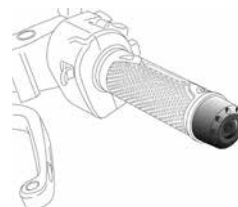

SHORT

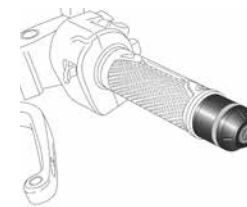

SHORT WITH RING

MODEL	YEAR	BAR ENDS MODEL	REFERENCE	R O A T N P V	C
Z1000SX	11' - 18'	SHORT	6186	(*)	(*)
Z1000SX	11' - 18'	SHORT WITH RING	8074	(*)	
Z1000SX	11' - 18'	THRUSTER	9409+9420	(*)	
ZR7	99' - 03'	LONG	5618	(*)	(*)
ZR7	99' - 03'	SHORT	6186	(*)	(*)
ZR7	99' - 03'	SHORT WITH RING	8074	(*)	
ZR7	99' - 03'	THRUSTER	9409+9420	(*)	
ZR7S	01' - 03'	LONG	5618	(*)	(*)
ZR7S	01' - 03'	SHORT	6186	(*)	(*)
ZR7S	01' - 03'	SHORT WITH RING	8074	(*)	
ZR7S	01' - 03'	THRUSTER	9409+9420	(*)	
ZRX1100	97' - 01'	LONG	5618	(*)	(*)
ZRX1100	97' - 01'	SHORT	6186	(*)	(*)
ZRX1100	97' - 01'	SHORT WITH RING	8074	(*)	
ZRX1100	97' - 01'	THRUSTER	9409+9420	(*)	
ZRX1200/S	01' - 07'	LONG	5618	(*)	(*)
ZRX1200/S	01' - 07'	SHORT	6186	(*)	(*)
ZRX1200/S	01' - 07'	SHORT WITH RING	8074	(*)	
ZRX1200/S	01' - 07'	THRUSTER	9409+9420	(*)	
ZX-6R	99' - 06'	LONG	5618	(*)	(*)
ZX-6R	99' - 06'	SHORT	6186	(*)	(*)
ZX-6R	99' - 06'	SHORT WITH RING	8074	(*)	
ZX-6R	99' - 06'	THRUSTER	9409+9420	(*)	
ZX-6R	07' - 08'	SHORT	6190	(*)	
ZX-6R	07' - 08'	SHORT WITH RING	8097	(*)	
ZX-6R	09' - 16'	LONG	5618	(*)	(*)
ZX-6R	09' - 16'	SHORT	6186	(*)	(*)
ZX-6R	09' - 16'	SHORT WITH RING	8074	(*)	
ZX-6R	09' - 16'	THRUSTER	9409+9420	(*)	
ZX-6R 636	13' - 16'	LONG	5618	(*)	(*)
ZX-6R 636	13' - 16'	SHORT	6186	(*)	(*)
ZX-6R 636	13' - 16'	SHORT WITH RING	8074	(*)	
ZX-6R 636	13' - 16'	THRUSTER	9409+9420	(*)	
ZX-7R	96' - 01'	LONG	5618	(*)	(*)
ZX-7R	96' - 01'	SHORT	6186	(*)	(*)
ZX-7R	96' - 01'	SHORT WITH RING	8074	(*)	
ZX-7R	96' - 01'	THRUSTER	9409+9420	(*)	
ZX-9R	94' - 04'	LONG	5618	(*)	(*)
ZX-9R	94' - 04'	SHORT	6186	(*)	(*)

MODEL	YEAR	BAR ENDS MODEL	REFERENCE	R O A T N P V	C
ZX-9R	94' - 04'	SHORT WITH RING	8074	(*)	
ZX-9R	94' - 04'	THRUSTER	9409+9420	(*)	
ZX-10R	04' - 10'	SHORT	6190	(*)	
ZX-10R	04' - 10'	SHORT WITH RING	8097	(*)	
ZX-10R	11' - 15'	LONG	5618	(*)	(*)
ZX-10R	11' - 15'	SHORT	6186	(*)	(*)
ZX-10R	11' - 15'	SHORT WITH RING	8074	(*)	
ZX-10R	11' - 15'	THRUSTER	9409+9420	(*)	
ZX-10R	16' - 18'	LONG	8840	(*)	(*)
ZX-10R	16' - 18'	SHORT WITH RING	8842	(*)	
ZX-10RR	17' - 18'	LARGO	8840	(*)	(*)
ZX-10RR	17' - 18'	SHORT WITH RING	8842	(*)	
ZX-10R SE	18'	LARGO	8840	(*)	(*)
ZX-10R SE	18'	SHORT WITH RING	8842	(*)	
ZX-12R	00' - 06'	LONG	5618	(*)	(*)
ZX-12R	00' - 06'	SHORT	6186	(*)	(*)
ZX-12R	00' - 06'	SHORT WITH RING	8074	(*)	
ZX-12R	00' - 06'	THRUSTER	9409+9420	(*)	
ZZR600	93' - 05'	LONG	5618	(*)	(*)
ZZR600	93' - 05'	SHORT	6186	(*)	(*)
ZZR600	93' - 05'	SHORT WITH RING	8074	(*)	
ZZR600	93' - 05'	THRUSTER	9409+9420	(*)	
ZZR1100	93' - 01'	LONG	5618	(*)	(*)
ZZR1100	93' - 01'	SHORT	6186	(*)	(*)
ZZR1100	93' - 01'	SHORT WITH RING	8074	(*)	
ZZR1100	93' - 01'	THRUSTER	9409+9420	(*)	
ZZR1200	02' - 05'	LONG	5618	(*)	(*)
ZZR1200	02' - 05'	SHORT	6186	(*)	(*)
ZZR1200	02' - 05'	SHORT WITH RING	8074	(*)	
ZZR1200	02' - 05'	THRUSTER	9409+9420	(*)	
ZZR1400	06' - 18'	LONG	5618	(*)	(*)
ZZR1400	06' - 18'	SHORT	6186	(*)	(*)
ZZR1400	06' - 18'	SHORT WITH RING	8074	(*)	
ZZR1400	06' - 18'	THRUSTER	9409+9420	(*)	
KTM					
125 DUKE	11' - 18'	LONG	5777	(*)	
125 DUKE	11' - 18'	SHORT	6203	(*)	
125 DUKE	11' - 18'	SHORT WITH RING	8498	(*)	
125 DUKE	11' - 18'	THRUSTER	9411+9420	(*)	
390 DUKE	13' - 16'	LONG	5777	(*)	
390 DUKE	13' - 16'	SHORT	6203	(*)	
390 DUKE	13' - 16'	SHORT WITH RING	8498	(*)	
390 DUKE	13' - 16'	THRUSTER	9411+9420	(*)	

R O A T N P V COLORS: BAR ENDS THRUSTER | REF. 9420 = SET OF CAPS BAR ENDS

R O A T N P V C COLORS: LONG BAR ENDS

R O A T N P V C COLORS: SHORT BAR ENDS

N COLORS: SHORT WITH RINGS BAR ENDS

(*) Check price with your distributor.

IMPORTANT: Indicate code color after part#. Example: 0973A.

BAR ENDS

HI-TECH PARTS | BAR ENDS MODEL:

2019
MODELS:
www.puig.tv

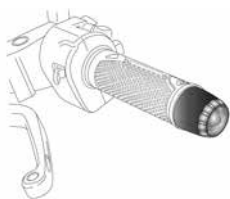

THRUSTER

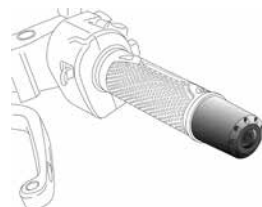

LONG

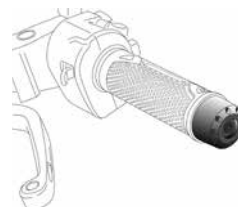

SHORT

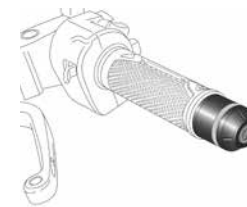

SHORT WITH RING

MODEL	YEAR	BAR ENDS MODEL	REFERENCE	R O A T N P V	C
390 DUKE	17' - 18'	LARGO	CHECK WEB		
390 DUKE	17' - 18'	SHORT	CHECK WEB		
390 DUKE	17' - 18'	SHORT WITH RING	CHECK WEB		
690 DUKE	12' - 18'	LONG	5777	(*)	
690 DUKE	12' - 18'	SHORT	6203	(*)	
690 DUKE	12' - 18'	SHORT WITH RING	8498	(*)	
690 DUKE	12' - 18'	THRUSTER	9411+9420	(*)	
690 DUKE R	12' - 17'	LONG	5777	(*)	
690 DUKE R	12' - 17'	SHORT	6203	(*)	
690 DUKE R	12' - 17'	SHORT WITH RING	8498	(*)	
690 DUKE R	12' - 17'	THRUSTER	9411+9420	(*)	
790 DUKE	18'	LONG	5777	(*)	
790 DUKE	18'	SHORT	6203	(*)	
790 DUKE	18'	SHORT WITH RING	8498	(*)	
790 DUKE	18'	THRUSTER	9411+9420	(*)	
RC125/390	14' - 18'	LONG	5777	(*)	
RC125/390	14' - 18'	SHORT	6203	(*)	
RC125/390	14' - 18'	SHORT WITH RING	8498	(*)	
RC125/390	14' - 18'	THRUSTER	9411+9420	(*)	
1290 SUPERDUKE R	14' - 18'	LONG	5777	(*)	
1290 SUPERDUKE R	14' - 18'	SHORT	6203	(*)	
1290 SUPERDUKE R	14' - 18'	SHORT WITH RING	8498	(*)	
1290 SUPERDUKE R	14' - 18'	THRUSTER	9411+9420	(*)	
1290 SUPERDUKE GT	16' - 18'	LONG	5777	(*)	
1290 SUPERDUKE GT	16' - 18'	SHORT	6203	(*)	
1290 SUPERDUKE GT	16' - 18'	SHORT WITH RING	8498	(*)	
1290 SUPERDUKE GT	16' - 18'	THRUSTER	9411+9420	(*)	
KYMCO					
AK 550	17' - 18'	LONG	9537	(*)	
MV AGUSTA					
BRUTALE 675	12' - 18'	SHORT WITH RING	8113	(*)	
BRUTALE 800/R	13' - 18'	SHORT WITH RING	8113	(*)	
BRUTALE 1090R	13'	LARGO	5777	(*)	
BRUTALE 1090R	13'	SHORT	6203	(*)	
BRUTALE 1090R	13'	SHORT WITH RING	8498	(*)	
BRUTALE 1090R	13'	THRUSTER	9411+9420	(*)	
SUZUKI					
B-KING	08' - 11'	LONG	5627	(*)	
B-KING	08' - 11'	SHORT	6192	(*)	(*)

MODEL	YEAR	BAR ENDS MODEL	REFERENCE	R O A T N P V C	
B-KING	08' - 11'	SHORT WITH RING	8505	(*)	
BURGMAN 400	17' - 18'	LARGO	8496	(*)	(*)
BURGMAN 400	17' - 18'	SHORT	8504	(*)	(*)
BURGMAN 400	17' - 18'	SHORT WITH RING	8505	(*)	
DL250-V-STROM	17' - 18'	LARGO	8496	(*)	(*)
DL250-V-STROM	17' - 18'	SHORT	8504	(*)	(*)
DL250-V-STROM	17' - 18'	SHORT WITH RING	8505	(*)	
DL650 V-STROM	04' - 11'	LONG	8496	(*)	(*)
DL650 V-STROM	04' - 11'	SHORT	8504	(*)	(*)
DL650 V-STROM	04' - 11'	SHORT WITH RING	8505	(*)	
DL650 V-STROM	12' - 18'	LONG	8496	(*)	(*)
DL650 V-STROM	12' - 18'	SHORT	8504	(*)	(*)
DL650 V-STROM	12' - 18'	SHORT WITH RING	8505	(*)	
DL650XT V-STROM	15' - 18'	LONG	8496	(*)	(*)
DL650XT V-STROM	15' - 18'	SHORT	8504	(*)	(*)
DL650XT V-STROM	15' - 18'	SHORT WITH RING	8505	(*)	
DL1000 V-STROM	02' - 07'	LONG	8496	(*)	(*)
DL1000 V-STROM	02' - 07'	SHORT	8504	(*)	(*)
DL1000 V-STROM	02' - 07'	SHORT WITH RING	8505	(*)	
DL1000 V-STROM	14' - 16'	LONG	8496	(*)	(*)
DL1000 V-STROM	14' - 16'	SHORT	8504	(*)	(*)
DL1000 V-STROM	14' - 16'	SHORT WITH RING	8505	(*)	
GS500F	04' - 07'	LONG	8496	(*)	(*)
GS500F	04' - 07'	SHORT	8504	(*)	(*)
GS500F	04' - 07'	SHORT WITH RING	8505	(*)	
GSF600 BANDIT	96' - 06'	LONG	8496	(*)	(*)
GSF600 BANDIT	96' - 06'	SHORT	8504	(*)	(*)
GSF600 BANDIT	96' - 06'	SHORT WITH RING	8505	(*)	
GSF600S BANDIT	96' - 04'	LONG	8496	(*)	(*)
GSF600S BANDIT	96' - 04'	SHORT	8504	(*)	(*)
GSF600S BANDIT	96' - 04'	SHORT WITH RING	8505	(*)	
GSF650 BANDIT/S	07' - 14'	LONG	8496	(*)	(*)
GSF650 BANDIT/S	07' - 14'	SHORT	8504	(*)	(*)
GSF650 BANDIT/S	07' - 14'	SHORT WITH RING	8505	(*)	
GSF1200 BANDIT/S	96' - 06'	LONG	8496	(*)	(*)
GSF1200 BANDIT/S	96' - 06'	SHORT	8504	(*)	(*)
GSF1200 BANDIT/S	96' - 06'	SHORT WITH RING	8505	(*)	
GSF1250 BANDIT/S	07' - 13'	LONG	8496	(*)	(*)
GSF1250 BANDIT/S	07' - 13'	SHORT	8504	(*)	(*)
GSF1250 BANDIT/S	07' - 13'	SHORT WITH RING	8505	(*)	
GSR600	06' - 11'	LONG	8496	(*)	(*)
GSR600	06' - 11'	SHORT	8504	(*)	(*)
GSR600	06' - 11'	SHORT WITH RING	8505	(*)	

- R O A T N P V COLORS: BAR ENDS THRUSTER | REF. 9420 = SET OF CAPS BAR ENDS
- R O A T N P V C COLORS: LONG BAR ENDS
- R O A T N P V C COLORS: SHORT BAR ENDS
- N COLORS: SHORT WITH RINGS BAR ENDS

(*) Check price with your distributor.

IMPORTANT: Indicate code color after part#. Example: 0973A.

BAR ENDS

HI-TECH PARTS | BAR ENDS MODEL:

2019
MODELS:
www.puig.tv

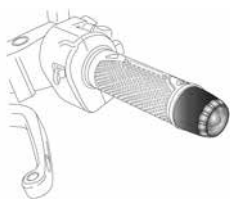

THRUSTER

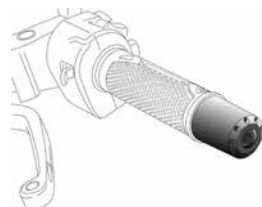

LONG

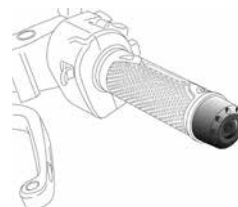

SHORT

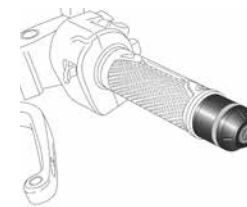

SHORT WITH RING

MODEL	YEAR	BAR ENDS MODEL	REFERENCE	R O A T N P V	C
GSR750	11' - 16'	LONG	8496	(*)	(*)
GSR750	11' - 16'	SHORT	8504	(*)	(*)
GSR750	11' - 16'	SHORT WITH RING	8505	(*)	
GSX650F	08' - 17'	LONG	8496	(*)	(*)
GSX650F	08' - 17'	SHORT	8504	(*)	(*)
GSX650F	08' - 17'	SHORT WITH RING	8505	(*)	
GSX750F	92' - 97'	LONG	8496	(*)	(*)
GSX750F	92' - 97'	SHORT	8504	(*)	(*)
GSX750F	92' - 97'	SHORT WITH RING	8505	(*)	
GSX1400	01' - 06'	LONG	8496	(*)	(*)
GSX1400	01' - 06'	SHORT	8504	(*)	(*)
GSX1400	01' - 06'	SHORT WITH RING	8505	(*)	
GSX1200	99' - 00'	LONG	8496	(*)	(*)
GSX1200	99' - 00'	SHORT	8504	(*)	(*)
GSX1200	99' - 00'	SHORT WITH RING	8505	(*)	
GSX1250F	10' - 17'	LONG	8496	(*)	(*)
GSX1250F	10' - 17'	SHORT	8504	(*)	(*)
GSX1250F	10' - 17'	SHORT WITH RING	8505	(*)	
GSX-R125	17' - 18'	LARGO	8496	(*)	(*)
GSX-R125	17' - 18'	SHORT	8504	(*)	(*)
GSX-R125	17' - 18'	SHORT WITH RING	8505	(*)	
GSX-R250	17' - 18'	LARGO	8496	(*)	(*)
GSX-R250	17' - 18'	SHORT	8504	(*)	(*)
GSX-R250	17' - 18'	SHORT WITH RING	8505	(*)	
GSX-R250	17' - 18'	THRUSTER	9417+9420	(*)	
GSX-R600	96' - 05'	LONG	8496	(*)	(*)
GSX-R600	96' - 05'	SHORT	8504	(*)	(*)
GSX-R600	96' - 05'	SHORT WITH RING	8505	(*)	
GSX-R600	06' - 16	LONG	8496	(*)	(*)
GSX-R600	06' - 16	SHORT	8504	(*)	(*)
GSX-R600	06' - 16	SHORT WITH RING	8505	(*)	
GSX-R750	96' - 05'	LONG	8496	(*)	(*)
GSX-R750	96' - 05'	SHORT	8504	(*)	(*)
GSX-R750	96' - 05'	SHORT WITH RING	8505	(*)	
GSX-R750	06' - 16'	LONG	8496	(*)	(*)
GSX-R750	06' - 16'	SHORT	8504	(*)	(*)
GSX-R750	06' - 16'	SHORT WITH RING	8505	(*)	
GSX-R1000	01' - 04'	LONG	8496	(*)	(*)
GSX-R1000	01' - 04'	SHORT	8504	(*)	(*)

MODEL	YEAR	BAR ENDS MODEL	REFERENCE	R O A T N P V C	C
GSX-R1000	01' - 04'	SHORT WITH RING	8505	(*)	
GSX-R1000	05' - 16'	LONG	8496	(*)	(*)
GSX-R1000	05' - 16'	SHORT	8504	(*)	(*)
GSX-R1000	05' - 16'	SHORT WITH RING	8505	(*)	
GSX-R1000/R	17' - 18'	LONG	9008	(*)	(*)
GSX-R1000/R	17' - 18'	SHORT	9009	(*)	(*)
GSX-R1000/R	17' - 18'	SHORT WITH RING	9010	(*)	
GSX-S125	17' - 18'	LARGO	5777	(*)	
GSX-S125	17' - 18'	SHORT	6203	(*)	
GSX-S125	17' - 18'	SHORT WITH RING	8498	(*)	
GSX-S125	17' - 18'	THRUSTER	9411+9420	(*)	
GSX-S750	17' - 18'	LONG	8496	(*)	(*)
GSX-S750	17' - 18'	SHORT	8504	(*)	(*)
GSX-S750	17' - 18'	SHORT WITH RING	8505	(*)	
GSX-S750	17' - 18'	THRUSTER	9417+9420	(*)	
GSX-S1000	15' - 18'	LONG	8496	(*)	(*)
GSX-S1000	15' - 18'	SHORT	8504	(*)	(*)
GSX-S1000	15' - 18'	SHORT WITH RING	8505	(*)	
GSX-S1000	15' - 18'	THRUSTER	9417+9420	(*)	
GSX-S1000F	15' - 18'	LONG	8496	(*)	(*)
GSX-S1000F	15' - 18'	SHORT	8504	(*)	(*)
GSX-S1000F	15' - 18'	SHORT WITH RING	8505	(*)	
GSX-S1000F	15' - 18'	THRUSTER	9417+9420	(*)	
GSX-R1300 HAYABUSA	99' - 07'	LONG	8496	(*)	(*)
GSX-R1300 HAYABUSA	99' - 07'	SHORT	8504	(*)	(*)
GSX-R1300 HAYABUSA	99' - 07'	SHORT WITH RING	8505	(*)	
GSX-R1300 HAYABUSA	08' - 12'	LONG	5626	(*)	
GSX-R1300 HAYABUSA	08' - 12'	SHORT	8504	(*)	(*)
GSX-R1300 HAYABUSA	08' - 12'	SHORT WITH RING	8505	(*)	
GSX-R1300 HAYABUSA	13' - 17'	LONG	5626	(*)	
GSX-R1300 HAYABUSA	13' - 17'	SHORT	8504	(*)	(*)
GSX-R1300 HAYABUSA	13' - 17'	SHORT WITH RING	8505	(*)	
SFV650 GLADIUS	09' - 15'	LONG	5627	(*)	
SFV650 GLADIUS	09' - 15'	SHORT	6192	(*)	(*)
SFV650 GLADIUS	09' - 15'	SHORT WITH RING	8505	(*)	
SV650	05' - 08'	LONG	5623	(*)	
SV650	05' - 08'	SHORT	8504	(*)	(*)
SV650	05' - 08'	SHORT WITH RING	8505	(*)	
SV650	05' - 08'	THRUSTER	9417+9420	(*)	
SV650S	03' - 08'	LONG	5623	(*)	
SV650S	03' - 08'	SHORT	8504	(*)	(*)
SV650S	03' - 08'	SHORT WITH RING	8505	(*)	
SV650S	03' - 08'	THRUSTER	9417+9420	(*)	

R O A T N P V COLORS: BAR ENDS THRUSTER | REF. 9420 = SET OF CAPS BAR ENDS

R O A T N P V C COLORS: LONG BAR ENDS

R O A T N P V C COLORS: SHORT BAR ENDS

N COLORS: SHORT WITH RINGS BAR ENDS

(*) Check price with your distributor.

IMPORTANT: Indicate code color after part#. Example: 0973A.

BAR ENDS

HI-TECH PARTS | BAR ENDS MODEL:

2019
MODELS:
www.puig.tv

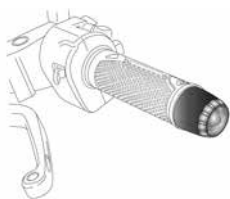

THRUSTER

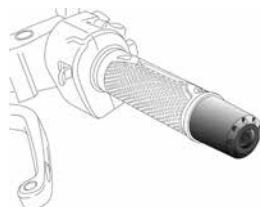

LONG

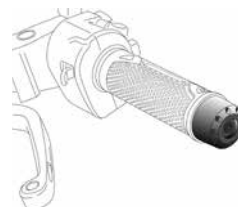

SHORT

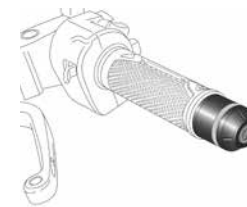

SHORT WITH RING

MODEL	YEAR	BAR ENDS MODEL	REFERENCE	R N	O P	A V	T V	C
SV650	16' - 18'	LONG	5627	(*)				
SV650	16' - 18'	SHORT	6192	(*)				(*)
SV650	16' - 18'	SHORT WITH RING	8505	(*)				
SV650X	18'	LONG	8496	(*)				(*)
SV650X	18'	SHORT	8504	(*)				(*)
SV650X	18'	SHORT WITH RING	8505	(*)				
SV1000/S	03' - 05'	LONG	5623	(*)				
SV1000/S	03' - 05'	SHORT	8504	(*)				(*)
SV1000/S	03' - 05'	SHORT WITH RING	8505	(*)				
SV1000/S	03' - 05'	THRUSTER	9417+9420	(*)				
TL1000R	98' - 99'	LONG	8496	(*)				(*)
TL1000R	98' - 99'	SHORT	8504	(*)				(*)
TL1000R	98' - 99'	SHORT WITH RING	8505	(*)				
TL1000S	97' - 00'	LONG	8496	(*)				(*)
TL1000S	97' - 00'	SHORT	8504	(*)				(*)
TL1000S	97' - 00'	SHORT WITH RING	8505	(*)				
TRIUMPH								
BONNEVILLE T100	16' - 18'	SHORT WITH RING	8860	(*)				
BONNEVILLE T120	16' - 18'	SHORT WITH RING	8860	(*)				
STREET TRIPLE/ R	13' - 16'	LONG	6640	(*)				(*)
STREET TRIPLE/ R	13' - 16'	SHORT	6653	(*)				(*)
STREET TRIPLE/ R	13' - 16'	SHORT WITH RING	8157	(*)				
STREET TRIPLE/R/S/RS	17' - 18'	SHORT WITH RING	8860	(*)				
STREET TWIN	16' - 18'	SHORT WITH RING	8860	(*)				
STREET SCRAMBLER	17' - 18'	SHORT WITH RING	8860	(*)				
TIGER SPORT	13' - 18'	SHORT WITH RING	8159	(*)				
YAMAHA								
FAZER8	13' - 16'	LONG	5621	(*)				
FAZER8	13' - 16'	SHORT	6199	(*)				
FAZER8	13' - 16'	SHORT WITH RING	8160	(*)				
FAZER8	13' - 16'	THRUSTER	9414+9420	(*)				
FJR1300A/AS	06' - 18'	LONG	5621	(*)				
FJR1300A/AS	06' - 18'	SHORT	6199	(*)				
FJR1300A/AS	06' - 18'	SHORT WITH RING	8160	(*)				
FJR1300A/AS	06' - 18'	THRUSTER	9414+9420	(*)				
FZ1	06' - 15'	LONG	5621	(*)				
FZ1	06' - 15'	SHORT	6199	(*)				
FZ1	06' - 15'	SHORT WITH RING	8160	(*)				
FZ1	06' - 15'	THRUSTER	9414+9420	(*)				

MODEL	YEAR	BAR ENDS MODEL	REFERENCE	R O A T N P V C	C
FZ1 FAZER	06' - 15'	LONG	6890	(*)	(*)
FZ1 FAZER	06' - 15'	SHORT	6891	(*)	(*)
FZ1 FAZER	06' - 15'	SHORT WITH RING	8170	(*)	
FZ1 FAZER	06' - 15'	THRUSTER	9416+9420	(*)	
FZ6	04' - 08'	LONG	6890	(*)	(*)
FZ6	04' - 08'	SHORT	6891	(*)	(*)
FZ6	04' - 08'	SHORT WITH RING	8170	(*)	
FZ6	04' - 08'	THRUSTER	9416+9420	(*)	
FZ8	10' - 16'	LONG	5621	(*)	
FZ8	10' - 16'	SHORT	6199	(*)	
FZ8	10' - 16'	SHORT WITH RING	8160	(*)	
FZ8	10' - 16'	THRUSTER	9414+9420	(*)	
FZ8 FAZER	10' - 12'	LONG	5621	(*)	
FZ8 FAZER	10' - 12'	SHORT	6199	(*)	
FZ8 FAZER	10' - 12'	SHORT WITH RING	8160	(*)	
FZ8 FAZER	10' - 12'	THRUSTER	9414+9420	(*)	
FZS600 FAZER	98' - 04'	LONG	5621	(*)	
FZS600 FAZER	98' - 04'	SHORT	6199	(*)	
FZS600 FAZER	98' - 04'	SHORT WITH RING	8160	(*)	
FZS600 FAZER	98' - 04'	THRUSTER	9414+9420	(*)	
FZS1000 FAZER	01' - 05'	LONG	6890	(*)	(*)
FZS1000 FAZER	01' - 05'	SHORT	6891	(*)	(*)
FZS1000 FAZER	01' - 05'	SHORT WITH RING	8170	(*)	
FZS1000 FAZER	01' - 05'	THRUSTER	9416+9420	(*)	
MT-125	14' - 18'	LONG	6890	(*)	(*)
MT-125	14' - 18'	SHORT	6891	(*)	(*)
MT-125	14' - 18'	SHORT WITH RING	8170	(*)	
MT-125	14' - 18'	THRUSTER	9416+9420	(*)	
MT-03	16' - 18'	LONG	8861	(*)	(*)
MT-03	16' - 18'	SHORT	8862	(*)	(*)
MT-03	16' - 18'	SHORT WITH RING	8863	(*)	
MT-07	14' - 18'	LONG	6890	(*)	(*)
MT-07	14' - 18'	SHORT	6891	(*)	(*)
MT-07	14' - 18'	SHORT WITH RING	8170	(*)	
MT-07	14' - 18'	THRUSTER	9416+9420	(*)	
MT-07 TRACER	16' - 18'	LONG	9207	(*)	(*)
MT-07 TRACER	16' - 18'	SHORT	9208	(*)	(*)
MT-07 TRACER	16' - 18'	SHORT WITH RING	9209	(*)	
MT-07 TRACER	16' - 18'	THRUSTER	9876+9420	(*)	
MT-09	13' - 18'	LONG	6890	(*)	(*)
MT-09	13' - 18'	SHORT	6891	(*)	(*)
MT-09	13' - 18'	SHORT WITH RING	8170	(*)	
MT-09	13' - 18'	THRUSTER	9416+9420	(*)	

R O A T N P V COLORS: BAR ENDS THRUSTER | REF. 9420 = SET OF CAPS BAR ENDS

R O A T N P V C COLORS: LONG BAR ENDS

R O A T N P V C COLORS: SHORT BAR ENDS

N COLORS: SHORT WITH RINGS BAR ENDS

(*) Check price with your distributor.

IMPORTANT: Indicate code color after part#. Example: 0973A.

BAR ENDS

HI-TECH PARTS | BAR ENDS MODEL:

2019
MODELS:
www.puig.tv

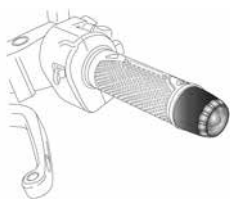

THRUSTER

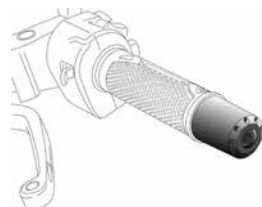

LONG

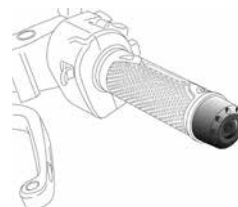

SHORT



SHORT WITH RING

MODEL	YEAR	BAR ENDS MODEL	REFERENCE	R O A T N P V	C
MT-09 SP	18'	LONG	6890	(*)	(*)
MT-09 SP	18'	SHORT	6891	(*)	(*)
MT-09 SP	18'	SHORT WITH RING	8170	(*)	
MT-09 SP	18'	THRUSTER	9416+9420	(*)	
MT-09 TRACER	15' - 17'	LONG	9372	(*)	(*)
MT-09 TRACER	15' - 17'	SHORT	9373	(*)	(*)
MT-09 TRACER	15' - 17'	SHORT WITH RING	9374	(*)	
MT-09 TRACER	15' - 17'	THRUSTER	9875+9420	(*)	
MT-10	16' - 18'	LONG	6890	(*)	(*)
MT-10	16' - 18'	SHORT	6891	(*)	(*)
MT-10	16' - 18'	SHORT WITH RING	8170	(*)	
MT-10	16' - 18'	THRUSTER	9416+9420	(*)	
MT-10 SP	17' - 18'	LONG	6890	(*)	(*)
MT-10 SP	17' - 18'	SHORT	6891	(*)	(*)
MT-10 SP	17' - 18'	SHORT WITH RING	8170	(*)	
MT-10 SP	17' - 18'	THRUSTER	9416+9420	(*)	
TDM 850	96' - 01'	LONG	6890	(*)	(*)
TDM 850	96' - 01'	SHORT	6891	(*)	(*)
TDM 850	96' - 01'	SHORT WITH RING	8170	(*)	
TDM 850	96' - 01'	THRUSTER	9416+9420	(*)	
TDM900	02' - 13'	LONG	6890	(*)	(*)
TDM900	02' - 13'	SHORT	6891	(*)	(*)
TDM900	02' - 13'	SHORT WITH RING	8170	(*)	
TDM900	02' - 13'	THRUSTER	9416+9420	(*)	
TZR50	98' - 16'	LONG	6890	(*)	(*)
TZR50	98' - 16'	SHORT	6891	(*)	(*)
TZR50	98' - 16'	SHORT WITH RING	8170	(*)	
TZR50	98' - 16'	THRUSTER	9416+9420	(*)	
T-MAX 500	08' - 11'	LONG	6890	(*)	(*)
T-MAX 500	08' - 11'	SHORT	6891	(*)	(*)
T-MAX 500	08' - 11'	SHORT WITH RING	8170	(*)	
T-MAX 500	08' - 11'	THRUSTER	9416+9420	(*)	
T-MAX 530	12' - 14'	LONG	6890	(*)	(*)
T-MAX 530	12' - 14'	SHORT	6891	(*)	(*)
T-MAX 530	12' - 14'	SHORT WITH RING	8170	(*)	
T-MAX 530	12' - 14'	THRUSTER	9416+9420	(*)	
T-MAX 530	15' - 16'	LONG	6890	(*)	(*)
T-MAX 530	15' - 16'	SHORT	6891	(*)	(*)
T-MAX 530	15' - 16'	SHORT WITH RING	8170	(*)	

MODEL	YEAR	BAR ENDS MODEL	REFERENCE	R O A T N P V C	C
T-MAX 530	15' - 16'	THRUSTER	9416+9420	(*)	
T-MAX 530/DX/SX	17' - 18'	LONG	6890	(*)	(*)
T-MAX 530/DX/SX	17' - 18'	SHORT	6891	(*)	(*)
T-MAX 530/DX/SX	17' - 18'	SHORT WITH RING	8170	(*)	
T-MAX 530/DX/SX	17' - 18'	THRUSTER	9416+9420	(*)	
XJ6	09' - 16'	LONG	6890	(*)	(*)
XJ6	09' - 16'	SHORT	6891	(*)	(*)
XJ6	09' - 16'	SHORT WITH RING	8170	(*)	
XJ6	09' - 16'	THRUSTER	9416+9420	(*)	
XJ6/DIVERSION	09' - 16'	LONG	6890	(*)	(*)
XJ6/DIVERSION	09' - 16'	SHORT	6891	(*)	(*)
XJ6/DIVERSION	09' - 16'	SHORT WITH RING	8170	(*)	
XJ6/DIVERSION	09' - 16'	THRUSTER	9416+9420	(*)	
XJ6 DIVERSION F	10' - 16'	LONG	6890	(*)	(*)
XJ6 DIVERSION F	10' - 16'	SHORT	6891	(*)	(*)
XJ6 DIVERSION F	10' - 16'	SHORT WITH RING	8170	(*)	
XJ6 DIVERSION F	10' - 16'	THRUSTER	9416+9420	(*)	
XJR1200	94' - 98'	LONG	6890	(*)	(*)
XJR1200	94' - 98'	SHORT	6891	(*)	(*)
XJR1200	94' - 98'	SHORT WITH RING	8170	(*)	
XJR1200	94' - 98'	THRUSTER	9416+9420	(*)	
XJR1300	99' - 16'	LONG	6890	(*)	(*)
XJR1300	99' - 16'	SHORT	6891	(*)	(*)
XJR1300	99' - 16'	SHORT WITH RING	8170	(*)	
XJR1300	99' - 16'	THRUSTER	9416+9420	(*)	
X-MAX 125 (M16)	10'-18'	LONG	6890	(*)	(*)
X-MAX 125(M6)	10'-18'	LONG	6276	(*)	
X-MAX 250 (M16)	10'-16'	LONG	6890	(*)	(*)
X-MAX 250(M6)	10'-16'	LONG	6276	(*)	
X-MAX 125	18'	LONG	8496	(*)	(*)
X-MAX 125	18'	SHORT	8504	(*)	(*)
X-MAX 125	18'	SHORT WITH RING	8505	(*)	
X-MAX 125	18'	THRUSTER	9417+9420	(*)	
X-MAX 400	13' - 17'	LONG	6890	(*)	(*)
X-MAX 400	13' - 17'	SHORT	6891	(*)	(*)
X-MAX 400	13' - 17'	SHORT WITH RING	8170	(*)	
X-MAX 400	13' - 17'	THRUSTER	9416+9420	(*)	
X-MAX 400	18'	LARGO	8496	(*)	(*)
X-MAX 400	18'	SHORT	8504	(*)	(*)
X-MAX 400	18'	SHORT WITH RING	8505	(*)	
X-MAX 400	18'	THRUSTER	9417+9420	(*)	
X-MAX 300	17' - 18'	LARGO	8496	(*)	(*)
X-MAX 300	17' - 18'	SHORT	8504	(*)	(*)

R O A T N P V COLORS: BAR ENDS THRUSTER | REF. 9420 = SET OF CAPS BAR ENDS
R O A T N P V C COLORS: LONG BAR ENDS
R O A T N P V C COLORS: SHORT BAR ENDS
N COLORS: SHORT WITH RINGS BAR ENDS

(*) Check price with your distributor.

IMPORTANT: Indicate code color after part#. Example: 0973A.

BAR ENDS

HI-TECH PARTS | BAR ENDS MODEL:

2019
MODELS:
www.puig.tv

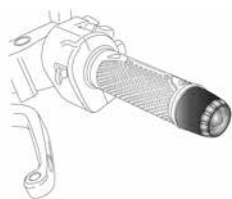

THRUSTER

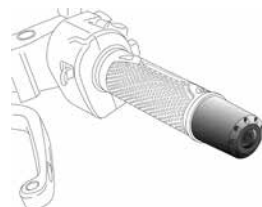

LONG

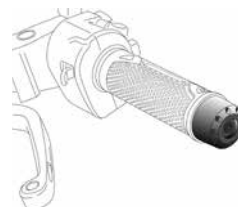

SHORT

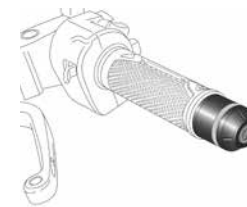

SHORT WITH RING

MODEL	YEAR	BAR ENDS MODEL	REFERENCE	R O A T N P V	C
X-MAX 300	17' - 18'	SHORT WITH RING	8505	(*)	
X-MAX 300	17' - 18'	THRUSTER	9417+9420	(*)	
XSR700	16' - 18'	LONG	6890	(*)	(*)
XSR700	16' - 18'	SHORT	6891	(*)	(*)
XSR700	16' - 18'	SHORT WITH RING	8170	(*)	
XSR700	16' - 18'	THRUSTER	9416+9420	(*)	
XSR900	16' - 18'	LONG	6890	(*)	(*)
XSR900	16' - 18'	SHORT	6891	(*)	(*)
XSR900	16' - 18'	SHORT WITH RING	8170	(*)	
XSR900	16' - 18'	THRUSTER	9416+9420	(*)	
YZF 600 R THUNDERCAT	96' - 02'	LONG	6890	(*)	(*)
YZF 600 R THUNDERCAT	96' - 02'	SHORT	6891	(*)	(*)
YZF 600 R THUNDERCAT	96' - 02'	SHORT WITH RING	8170	(*)	
YZF 600 R THUNDERCAT	96' - 02'	THRUSTER	9416+9420	(*)	
YZF 1000 R THUNDERACE	96' - 03'	LONG	6890	(*)	(*)
YZF 1000 R THUNDERACE	96' - 03'	SHORT	6891	(*)	(*)
YZF 1000 R THUNDERACE	96' - 03'	SHORT WITH RING	8170	(*)	
YZF 1000 R THUNDERACE	96' - 03'	THRUSTER	9416+9420	(*)	
YZF-R125	08' - 13'	LONG	6890	(*)	(*)
YZF-R125	08' - 13'	SHORT	6891	(*)	(*)
YZF-R125	08' - 13'	SHORT WITH RING	8170	(*)	
YZF-R125	08' - 13'	THRUSTER	9416+9420	(*)	
YZF-R125	14' - 18'	LONG	7581	(*)	
YZF-R125	14' - 18'	SHORT	7580	(*)	(*)
YZF-R125	14' - 18'	SHORT WITH RING	8173	(*)	
YZF-R1	98' - 14'	LONG	5621	(*)	
YZF-R1	98' - 14'	SHORT	6199	(*)	
YZF-R1	98' - 14'	SHORT WITH RING	8160	(*)	
YZF-R1	98' - 14'	THRUSTER	9414+9420	(*)	
YZF-R1	15' - 18'	LONG	8007	(*)	(*)
YZF-R1	15' - 18'	SHORT	8008	(*)	(*)
YZF-R1	15' - 18'	SHORT WITH RING	8189	(*)	
YZF-R1	15' - 18'	THRUSTER	9874+9420	(*)	
YZF-R1M	17' - 18'	LONG	8007	(*)	(*)
YZF-R1M	17' - 18'	SHORT	8008	(*)	(*)
YZF-R1M	17' - 18'	SHORT WITH RING	8189	(*)	
YZF-R1M	17' - 18'	THRUSTER	9874+9420	(*)	
YZF-R3	15' - 18'	LONG	5777	(*)	
YZF-R3	15' - 18'	SHORT	6203	(*)	

MODEL	YEAR	BAR ENDS MODEL	REFERENCE	R O A T N P V C	
YZF-R3	15' - 18'	SHORT WITH RING	8498	(*)	
YZF-R3	15' - 18'	THRUSTER	9411+9420	(*)	
YZF-R6	99' - 02'	LONG	7581	(*)	
YZF-R6	99' - 02'	SHORT	7580	(*)	(*)
YZF-R6	99' - 02'	SHORT WITH RING	8173	(*)	
YZF-R6	06' - 16'	LONG	5621	(*)	
YZF-R6	06' - 16'	SHORT	6199	(*)	
YZF-R6	06' - 16'	SHORT WITH RING	8160	(*)	
YZF-R6	06' - 16'	THRUSTER	9414+9420	(*)	
YZF-R6	17' - 18'	LONG	8007	(*)	(*)
YZF-R6	17' - 18'	SHORT	8008	(*)	(*)
YZF-R6	17' - 18'	SHORT WITH RING	8189	(*)	
YZF-R6	17' - 18'	THRUSTER	9874+9420	(*)	

R O A T N P V COLORS: **BAR ENDS THRUSTER** | REF. 9420 = SET OF CAPS BAR ENDS
R O A T N P V C COLORS: **LONG BAR ENDS**
R O A T N P V C COLORS: **SHORT BAR ENDS**
N COLORS: **SHORT WITH RINGS BAR ENDS**

(*) Check price with your distributor.

IMPORTANT: Indicate code color after part#. Example: 0973A.

PLUG-OIL CAPS

TYPES OF PLUG-OIL CAPS

2019
MODELS:
www.puig.tv

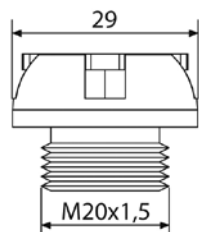

REF. 6155

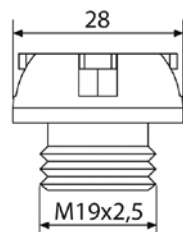

REF. 6156

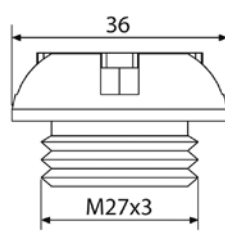

REF. 6157

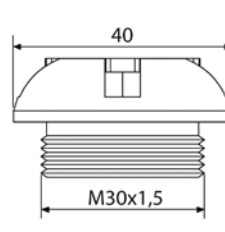

REF. 6158

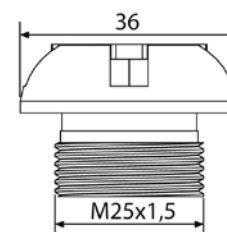

REF. 6777

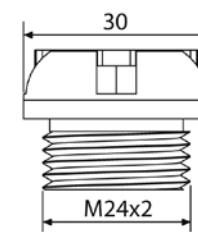

REF. 6778

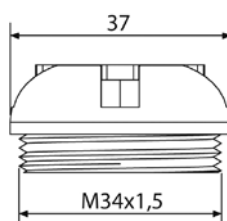

REF. 6779

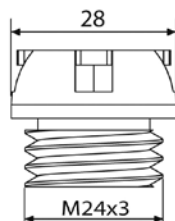

REF. 6780

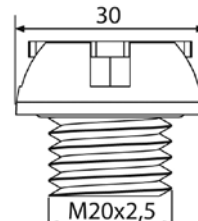

REF. 6781

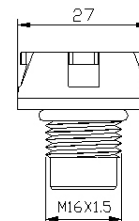

REF. 7140

MODEL	YEAR	REF.	R	O	A	T	N	P	V
APRILIA									
DORSODURO 750	08' - 16'	6777	(*)						
DORSODURO 900	17' - 18'	6777	(*)						
RSV4	09' - 12'	6777	(*)						
RSV4 FACTORY	13' - 14'	6777	(*)						
RSV4 R	13' - 14'	6777	(*)						
RSV4 RF	15' - 18'	6777	(*)						
RSV4 RR	15' - 18'	6777	(*)						
SHIVER 750	07' - 16'	6777	(*)						
SHIVER 900	17' - 18'	6155	(*)						
TUONO 1000R	06' - 10'	6777	(*)						
TUONO V4R	11' - 14'	6777	(*)						
TUONO V4 1100 RR	15' - 18'	6777	(*)						
TUONO V4 1100 FACTORY	15' - 18'	6777	(*)						
BMW									
G310 R	16' - 18'	8764	(*)						
R1200 GS	04' - 18'	6779	(*)						
R1200GS EXCLUSIVE	17' - 18'	6779	(*)						
R1200GS RALLYE	17' - 18'	6779	(*)						
R1200 GS ADVENTURE	06' - 18'	6779	(*)						
R1250GS	18'	6779	(*)						
R1200 S	06' - 08'	6779	(*)						
R1200 R	15' - 18'	6779	(*)						
R1200 RS	15' - 18'	6779	(*)						
R NINE T	14' - 18'	6779	(*)						
R NINE T SCRAMBLER	16' - 18'	6779	(*)						

MODEL	YEAR	REF.	R	O	A	T	N	P	V
R NINE T URBAN G/S	17' - 18'	6779	(*)						
R NINE T PURE/RACER	17' - 18'	6779	(*)						
S1000 R	14' - 18'	6778	(*)						
S1000 RR	09' - 18'	6778	(*)						
S1000 XR	15' - 18'	6778	(*)						
DUCATI									
848	08' - 13'	6156	(*)						
899 PANIGALE	14' - 15'	6156	(*)						
959 PANIGALE	16' - 18'	6156	(*)						
959 PANIGALE CORSE	18'	6156	(*)						
PANIGALE V4	18'	6156	(*)						
PANIGALE V4S	18'	6156	(*)						
PANIGALE V4 SPECIALE	18'	6156	(*)						
1299 PANIGALE/S	15' - 17'	6156	(*)						
HYPERMOTARD 796	10' - 13'	6156	(*)						
HYPERMOTARD 821/SP	13' - 15'	6156	(*)						
HYPERMOTARD 939/SP	16' - 18'	6156	(*)						
HYPERSTRADA 939/SP	16' - 17'	6156	(*)						
MONSTER 696	08' - 14'	6156	(*)						
MONSTER 796	10' - 14'	6156	(*)						
MONSTER 797	17' - 18'	6156	(*)						
MONSTER 1100	09' - 10'	6156	(*)						
MONSTER 1100 EVO	11' - 13'	6156	(*)						
MONSTER 821	14' - 18'	6156	(*)						
MONSTER 1200/S	14' - 18'	6156	(*)						
MONSTER 1200 R	16' - 18'	6156	(*)						

MODEL	YEAR	REF.	R O A T N P V
MULTISTRADA 950	17' - 18'	6156	(*)
MULTISTRADA 1200/S	10' - 17'	6156	(*)
MULTISTRAD 1200 ENDURO/PRO	16' - 18'	6156	(*)
MULTISTRADA 1200 PIKES PEAK	16' - 17'	6156	(*)
MULTISTRADA 1260/S/S DJAIR	18'	6156	(*)
MULTISTRADA 1260 PIKES PEAK	18'	6156	(*)
SCRAMBLER ICON/CLASSIC/FULL THROTTLE	15' - 18'	6156	(*)
SCRAMBLER SIXTY2	16' - 18'	6156	(*)
SCRAMBLER URBAN ENDURO	15' - 16'	6156	(*)
SCRAMBLER FLAT TRACK PRO	16'	6156	(*)
SCRAMBLER DESERT SLED	17' - 18'	6156	(*)
SCRAMBLER 1100	18'	6156	(*)
SCRAMBLER 1100 SPORT	18'	6156	(*)
SCRAMBLER 1100 SPECIAL	18'	6156	(*)
STREETFIGHTER 848	12' - 15'	6156	(*)
SUPERSPORT 939/S	17' - 18'	6156	(*)
X DIAVEL/S	16' - 18'	6156	(*)
HONDA			
CB125F	15' - 18'	6156	(*)
CB300F	15' - 18'	6156	(*)
CB500F	13' - 18'	6156	(*)
CB500X	13' - 18'	6156	(*)
CB600F HORNET	02' - 15'	6156	(*)
CB650F	14' - 18'	6156	(*)
CB1000R	08' - 16'	6156	(*)
CB1000R NEO SPORTS CAFE	18'	6156	(*)
CB1100	13' - 14'	6156	(*)
CB1100EX	14 - 18'	6156	(*)
CB1100RS	17' - 18'	6156	(*)
CBF600	04' - 14'	6156	(*)
CBF600S	08' - 14'	6156	(*)
CBF1000	06' - 11'	6156	(*)
CBR600F	01' - 07'	6156	(*)
CBR600F	11' - 13'	6156	(*)
CBR650F	14' - 16'	6156	(*)
CBR125R	07' - 16'	6156	(*)
CBR250R	11' - 15'	6156	(*)
CBR300R	15' - 17'	6156	(*)
CBR500R	13' - 18'	6156	(*)
CBR600RR	03' - 16'	6156	(*)
CBR900RR FIRE BLADE	00' - 03'	6156	(*)

MODEL	YEAR	REF.	R O A T N P V
CBR1000RR FIREBLADE	04' - 13'	6156	(*)
CBR1000RR FIREBLADE /SP	14' - 16'	6156	(*)
CBR1000RR FIREBLADE/SP/SP2	17' - 18'	6156	(*)
CRF1000L AFRICA TWIN	16' - 18'	6156	(*)
CMX 500 REBEL	17' - 18'	6156	(*)
CROSSTOURER	12' - 18'	6156	(*)
INTEGRA 700	12' - 13'	6156	(*)
INTEGRA 750	14' - 18'	6156	(*)
NC750S/X	14' - 18'	6156	(*)
NT650V DEAUVILLE	98' - 05'	6156	(*)
NT700V DEAUVILLE	06' - 12'	6156	(*)
VFR800F	14' - 18'	6156	(*)
VFR1200F	10' - 16'	6156	(*)
VTR1000F FIRE STORM	97' - 07'	6156	(*)
VTR1000 SP-1	00' - 02'	6156	(*)
VTR1000 SP-2	02' - 05'	6156	(*)
XL600V TRANSALP	87' - 93'	6156	(*)
XL650V TRANSALP	00' - 07'	6156	(*)
XL1000V VARADERO	99' - 11'	6156	(*)
X-ADV	17' - 18'	6156	(*)
KAWASAKI			
GTR1400	07' - 17'	6158	(*)
NINJA 250R	08' - 12'	6158	(*)
NINJA 250SL	15' - 16'	6156	(*)
NINJA 300	13' - 17'	6158	(*)
NINJA 400	18'	6156	(*)
NINJA 650	17' - 18'	6156	(*)
NINJA H2 SX	18'	6158	(*)
ER-6F	06' - 16'	6156	(*)
ER-6N	06' - 16'	6156	(*)
VERSYS X-300	17' - 18'	6158	(*)
VERSYS 650	07' - 18'	6156	(*)
VERSYS 1000	12' - 18'	6156	(*)
VULCAN S	15' - 18'	6156	(*)
VULCAN CAFE	17' - 18'	6156	(*)
Z250SL	15' - 16'	6156	(*)
Z300	15' - 17'	6158	(*)
Z650	17' - 18'	6156	(*)
Z800	13' - 16'	6156	(*)
Z800E	13' - 16'	6156	(*)
Z900	17' - 18'	6156	(*)

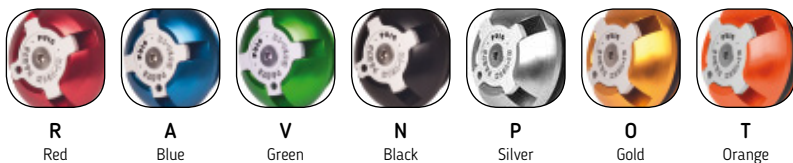

WE RECOMMEND TO VERIFY THE MEASUREMENTS OF THE ORIGINAL CAP AND PITCH THREAD WHEN ORDERING.

(*) Check price with your distributor.

IMPORTANT: Indicate code color after part#. Example: 0973A.

PLUG-OIL CAPS

TYPES OF PLUG-OIL CAPS

2019
MODELS:
www.puig.tv

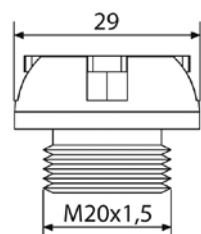

REF. 6155

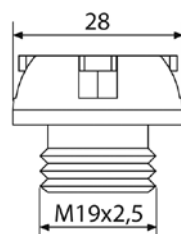

REF. 6156

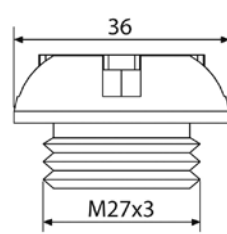

REF. 6157

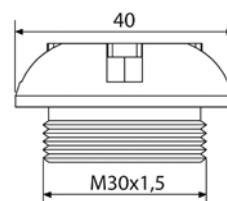

REF. 6158

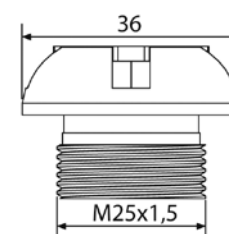

REF. 6777

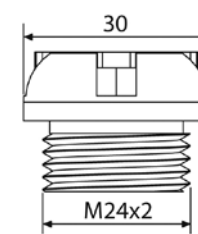

REF. 6778

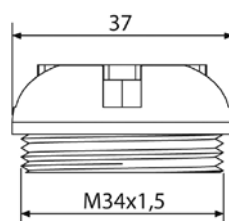

REF. 6779

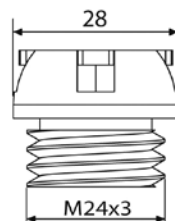

REF. 6780

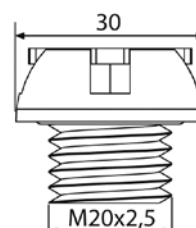

REF. 6781

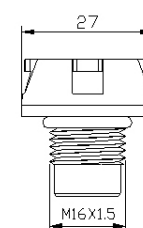

REF. 7140

MODEL	YEAR	REF.	R D A T N P V
Z900RS	18'	6156	(*)
Z1000	10' - 18'	6156	(*)
Z1000R	17' - 18'	6156	(*)
Z1000SX	11' - 13'	6156	(*)
Z1000SX	14' - 16'	6156	(*)
Z1000SX	17' - 18'	6156	(*)
ZX-6R	03' - 16'	6158	(*)
ZX-6R 636	13' - 16'	6158	(*)
ZX-10R	16' - 18'	6158	(*)
ZX-10RR	17' - 18'	6158	(*)
ZZR1200	02' - 05'	6158	(*)
ZZR1400	06' - 18'	6158	(*)
KTM			
125 DUKE	11' - 18'	7140	(*)
200 DUKE	12' - 15'	7140	(*)
390 DUKE	13' - 18'	7140	(*)
690 DUKE/R	12' - 18'	6780	(*)
690 DUKE R	12' - 17'	6780	(*)
790 DUKE	18'	6780	(*)
990 SUPERMOTO/R	08' - 13'	6780	(*)
1290 SUPERDUKE R	14' - 18'	6780	(*)
1290 SUPERDUKE GT	16' - 18'	6780	(*)
RC125/390	14' - 18'	7140	(*)
SUZUKI			
B-KING	08' - 11'	6155	(*)
DL250 V-STROM	17' - 18'	6155	(*)

MODEL	YEAR	REF.	R D A T N P V
DL650 V-STROM	04' - 18'	6155	(*)
DL650XT V-STROM	15' - 18'	6155	(*)
DL1000 V-STROM	14' - 18'	6155	(*)
DL1000XT V-STROM	17' - 18'	6155	(*)
DR800	91' - 99'	6155	(*)
GS500F	04' - 07'	6155	(*)
GSF650 BANDIT	09' - 11'	6155	(*)
GSF650S BANDIT	05' - 14'	6155	(*)
GSF1200S BANDIT	01' - 06'	6155	(*)
GSF1250 BANDIT	10' - 13'	6155	(*)
GSF1250S BANDIT	07' - 16'	6155	(*)
GSR600	06' - 11'	6155	(*)
GSR750	11' - 16'	6155	(*)
GSX650F	08' - 16'	6155	(*)
GSX1250F	10' - 17'	6155	(*)
GSX-S125	17' - 18'	6155	(*)
GSX-S750	17' - 18'	6155	(*)
GSX-S1000	15' - 18'	6155	(*)
GSX-S1000F	15' - 18'	6155	(*)
GSX-R125	17' - 18'	6155	(*)
GSX-R250	17' - 18'	6155	(*)
GSX-R600	01' - 16'	6155	(*)
GSX-R750	01' - 16'	6155	(*)
GSX-R1000	01' - 16'	6155	(*)
GSX-R1000/R	17' - 18'	6155	(*)
GSX-R1300 HAYABUSA	99' - 17'	6155	(*)

MODEL	YEAR	REF.	R O A T N P V
INAZUMA	13' - 17'	6155	(*)
INAZUMA F	15' - 17'	6155	(*)
SFV650 GLADIUS	09' - 15'	6155	(*)
SV650	16' - 18'	6155	(*)
SV650X	18'	6155	(*)
TL1000R	98' - 99'	6155	(*)
TRIUMPH			
DAYTONA 675	06' - 12'	6156	(*)
DAYTONA 675	13' - 17'	6156	(*)
DAYTONA 675 R	13' - 17'	6156	(*)
SPEED TRIPLE	11' - 15'	6156	(*)
SPEED TRIPLE R	12' - 15'	6156	(*)
SPEED TRIPLE/R	16' - 18'	6156	(*)
STREET TRIPLE	08' - 18'	6156	(*)
STREET TRIPLE R	09' - 18'	6156	(*)
TIGER 800	11' - 14'	6156	(*)
TIGER 800 XC	11' - 14'	6156	(*)
TIGER 800 XC/XCX/XCA	15' - 18'	6156	(*)
TIGER 800 XR/XRX/XRT	15' - 18'	6156	(*)
TIGER EXPLORER	12' - 15'	6156	(*)
TIGER EXPLORER XC	13' - 15'	6156	(*)
TIGER EXPLORER XC/XR/XRX/XRT/XCX/XCA	16' - 18'	6156	(*)
YAMAHA			
FAZER8	13' - 16'	6157	(*)
FZS600 FAZER	98' - 04'	6157	(*)
FZS1000 FAZER	01' - 05'	6157	(*)
FZ1	06' - 15'	6157	(*)
FZ1 FAZER	06' - 15'	6157	(*)
FZ750	87' - 95'	6157	(*)
FZ8	10' - 16'	6157	(*)
FZ8 FAZER	10' - 12'	6157	(*)
MT-125	14' - 18'	6157	(*)
MT-07	14' - 18'	6157	(*)
MT-07 TRACER	16' - 18'	6157	(*)
MT-09	13' - 18'	6781	(*)
MT-09 SP	18'	6781	(*)
MT-09 TRACER	15' - 18'	6781	(*)
MT-09 TRACER GT	18'	6781	(*)
MT-10	16' - 18'	6157	(*)
MT-10 SP	17' - 18'	6157	(*)
T-MAX 530	12' - 16'	6781	(*)

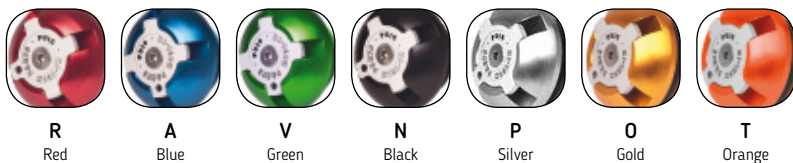

MODEL	YEAR	REF.	R O A T N P V
T-MAX 530/DX/SX	17' - 18'	6781	(*)
XJ6	09' - 16'	6157	(*)
XJ6 DIVERSION	09' - 16'	6157	(*)
XJ6 DIVERSION F	10' - 16'	6157	(*)
XSR900	16' - 18'	6781	(*)
XSR700	16' - 18'	6157	(*)
XT660X	04' - 16'	6157	(*)
XT660R	04' - 16'	6157	(*)
XT660Z TÉNÉRÉ	08' - 16'	6157	(*)
XT1200Z SUPER TÉNÉRÉ	10' - 18'	6157	(*)
YZF 1000 R THUNDERACE	96' - 03'	6157	(*)
YZF-R1	98' - 18'	6157	(*)
YZF-R3	15' - 18'	6157	(*)
YZF-R6	99' - 18'	6157	(*)

WE RECOMMEND TO VERIFY THE MEASUREMENTS OF THE ORIGINAL CAP AND PITCH THREAD WHEN ORDERING.

(*) Check price with your distributor.

IMPORTANT: Indicate code color after part#. Example: 0973A.

SPOOLS

HI-TECH PARTS | TYPE OF SPOOL:

2019
MODELS:
www.puig.tv

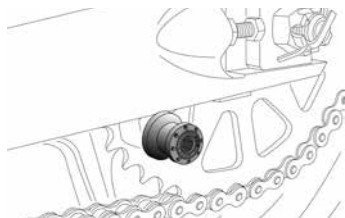

SPOOL



SPOOL SLIDER



SPOOL PRO

MODEL	YEAR	TYPE OF SPOOL	SCREW	REF.	
APRILIA					
CAPONORD 1200	13' - 16'	SPOOL	M6	5922	(*)
CAPONORD 1200	13' - 16'	SPOOL PRO	M6	9258	(*)
CAPONORD 1200	13' - 16'	SPOOL SLIDER	M6	4031	(*)
DORSODURO 750	08' - 16'	SPOOL	M6	5922	(*)
DORSODURO 750	08' - 16'	SPOOL PRO	M6	9258	(*)
DORSODURO 750	08' - 16'	SPOOL SLIDER	M6	4031	(*)
DORSODURO 900	17' - 18'	SPOOL	M6	5922	(*)
DORSODURO 900	17' - 18'	SPOOL PRO	M6	9258	(*)
DORSODURO 900	17' - 18'	SPOOL SLIDER	M6	4031	(*)
DORSODURO 1200	11' - 16'	SPOOL	M6	5922	(*)
DORSODURO 1200	11' - 16'	SPOOL PRO	M6	9258	(*)
DORSODURO 1200	11' - 16'	SPOOL SLIDER	M6	4031	(*)
MANA 850	07' - 16'	SPOOL	M6	5922	(*)
MANA 850	07' - 16'	SPOOL PRO	M6	9258	(*)
MANA 850	07' - 16'	SPOOL SLIDER	M6	4031	(*)
MANA GT 850	09' - 16'	SPOOL	M6	5922	(*)
MANA GT 850	09' - 16'	SPOOL PRO	M6	9258	(*)
MANA GT 850	09' - 16'	SPOOL SLIDER	M6	4031	(*)
PEGASO STRADA 650	05' - 09'	SPOOL	M6	5922	(*)
PEGASO STRADA 650	05' - 09'	SPOOL PRO	M6	9258	(*)
PEGASO STRADA 650	05' - 09'	SPOOL SLIDER	M6	4031	(*)
PEGASO TRAIL 650	06' - 09'	SPOOL	M6	5922	(*)
PEGASO TRAIL 650	06' - 09'	SPOOL PRO	M6	9258	(*)
PEGASO TRAIL 650	06' - 09'	SPOOL SLIDER	M6	4031	(*)
RS 50/ RS 125/ RS 250	99' - 05'	SPOOL	M6	5922	(*)
RS 50/ RS 125/ RS 250	99' - 05'	SPOOL PRO	M6	9258	(*)
RS 50/ RS 125/ RS 250	99' - 05'	SPOOL SLIDER	M6	4031	(*)
RS 50/ RS 125	06' - 10'	SPOOL	M6	5922	(*)
RS 50/ RS 125	06' - 10'	SPOOL PRO	M6	9258	(*)
RS 50/ RS 125	06' - 10'	SPOOL SLIDER	M6	4031	(*)
RS4 50/RS4 125	11' - 18'	SPOOL	M6	5922	(*)
RS4 50/RS4 125	11' - 18'	SPOOL PRO	M6	9258	(*)
RS4 50/RS4 125	11' - 18'	SPOOL SLIDER	M6	4031	(*)
RSV1000 MILLE	98' - 00'	SPOOL	M6	5922	(*)
RSV1000 MILLE	98' - 00'	SPOOL PRO	M6	9258	(*)
RSV1000 MILLE	98' - 00'	SPOOL SLIDER	M6	4031	(*)
RSV1000 MILLE	02' - 03'	SPOOL	M6	5922	(*)

MODEL	YEAR	TYPE OF SPOOL	SCREW	REF.	
RSV1000 MILLE	02' - 03'	SPOOL PRO	M6	9258	(*)
RSV1000 MILLE	02' - 03'	SPOOL SLIDER	M6	4031	(*)
RSV1000 R MILLE	00' - 02'	SPOOL	M6	5922	(*)
RSV1000 R MILLE	00' - 02'	SPOOL PRO	M6	9258	(*)
RSV1000 R MILLE	00' - 02'	SPOOL SLIDER	M6	4031	(*)
RSV1000 R MILLE	04' - 08'	SPOOL	M6	5922	(*)
RSV1000 R MILLE	04' - 08'	SPOOL PRO	M6	9258	(*)
RSV1000 R MILLE	04' - 08'	SPOOL SLIDER	M6	4031	(*)
RSV4	09' - 12'	SPOOL	M6	5922	(*)
RSV4	09' - 12'	SPOOL PRO	M6	9258	(*)
RSV4	09' - 12'	SPOOL SLIDER	M6	4031	(*)
RSV4 FACTORY	13' - 14'	SPOOL	M6	5922	(*)
RSV4 FACTORY	13' - 14'	SPOOL PRO	M6	9258	(*)
RSV4 FACTORY	13' - 14'	SPOOL SLIDER	M6	4031	(*)
RSV4 R	13' - 14'	SPOOL	M6	5922	(*)
RSV4 R	13' - 14'	SPOOL PRO	M6	9258	(*)
RSV4 R	13' - 14'	SPOOL SLIDER	M6	4031	(*)
RSV4 RF/RR	15' - 17'	SPOOL	M6	5922	(*)
RSV4 RF/RR	15' - 17'	SPOOL PRO	M6	9258	(*)
RSV4 RF/RR	15' - 17'	SPOOL SLIDER	M6	4031	(*)
SHIVER 750	07' - 16'	SPOOL	M6	5922	(*)
SHIVER 750	07' - 16'	SPOOL PRO	M6	9258	(*)
SHIVER 750	07' - 16'	SPOOL SLIDER	M6	4031	(*)
SHIVER 750 GT	08' - 16'	SPOOL	M6	5922	(*)
SHIVER 750 GT	08' - 16'	SPOOL PRO	M6	9258	(*)
SHIVER 750 GT	08' - 16'	SPOOL SLIDER	M6	4031	(*)
SHIVER 900	17' - 18'	SPOOL	M6	5922	(*)
SHIVER 900	17' - 18'	SPOOL PRO	M6	9258	(*)
SHIVER 900	17' - 18'	SPOOL SLIDER	M6	4031	(*)
TUONO 125	17' - 18'	SPOOL	M6	5922	(*)
TUONO 125	17' - 18'	SPOOL PRO	M6	9258	(*)
TUONO 125	17' - 18'	SPOOL SLIDER	M6	4031	(*)
TUONO 1000R	06' - 10'	SPOOL	M6	5922	(*)
TUONO 1000R	06' - 10'	SPOOL PRO	M6	9258	(*)
TUONO 1000R	06' - 10'	SPOOL SLIDER	M6	4031	(*)
TUONO V4R	11' - 14'	SPOOL	M6	5922	(*)
TUONO V4R	11' - 14'	SPOOL PRO	M6	9258	(*)
TUONO V4R	11' - 14'	SPOOL SLIDER	M6	4031	(*)
TUONO V4 1100 RR	15' - 18'	SPOOL	M6	5922	(*)
TUONO V4 1100 RR	15' - 18'	SPOOL PRO	M6	9258	(*)
TUONO V4 1100 RR	15' - 18'	SPOOL SLIDER	M6	4031	(*)
TUONO V4 1100 FACTORY	15' - 18'	SPOOL	M6	5922	(*)
TUONO V4 1100 FACTORY	15' - 18'	SPOOL PRO	M6	9258	(*)



R
Red



A
Blue



N
Black



V
Green



P
Silver



O
Gold



T
Orange

SPOOL
SPOOL PRO



N
Black Nylon

SPOOL
SLIDER

Part numbers that appear in the list are compatible with most bikes. Nevertheless, we advise to check the dimensions of OEM piece.

(*) Check price with your distributor.

IMPORTANT: Indicate code color after part#. Example: 0973A.

SPOOLS

HI-TECH PARTS | TYPE OF SPOOL:

2019
MODELS:
www.puig.tv

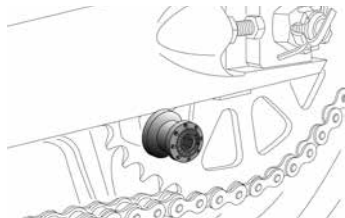

SPOOL



SPOOL SLIDER

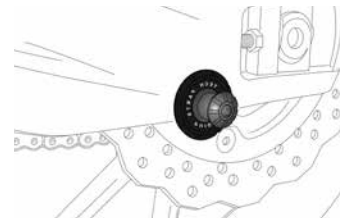

SPOOL PRO

MODEL	YEAR	TYPE OF SPOOL	SCREW	REF.	R N	O P	A V	T V	
TUONO V4 1100 FACTORY	15' - 18'	SPOOL SLIDER	M6	4031				(*)	
BMW									
S1000 R	14' - 18'	SPOOL	M8	5923				(*)	
S1000 R	14' - 18'	SPOOL PRO	M8	9259				(*)	
S1000 R	14' - 18'	SPOOL SLIDER	M8	7184				(*)	
S1000 XR	15' - 18'	SPOOL	M8	5923				(*)	
S1000 XR	15' - 18'	SPOOL PRO	M8	9259				(*)	
S1000 XR	15' - 18'	SPOOL SLIDER	M8	7184				(*)	
S1000 RR	09' - 18'	SPOOL	M8	5923				(*)	
S1000 RR	09' - 18'	SPOOL PRO	M8	9259				(*)	
S1000 RR	09' - 18'	SPOOL SLIDER	M8	7184				(*)	
BENELLI									
TRK 502	16' - 18'	SPOOL	M6	5922				(*)	
TRK 502	16' - 18'	SPOOL PRO	M6	9258				(*)	
TRK 502	16' - 18'	SPOOL SLIDER	M6	4031				(*)	
DUCATI									
899 PANIGALE	14' - 15'	SPOOL	M6	5922				(*)	
899 PANIGALE	14' - 15'	SPOOL PRO	M6	9258				(*)	
899 PANIGALE	14' - 15'	SPOOL SLIDER	M6	4031				(*)	
959 PANIGALE	16' - 18'	SPOOL	M6	5922				(*)	
959 PANIGALE	16' - 18'	SPOOL PRO	M6	9258				(*)	
959 PANIGALE	16' - 18'	SPOOL SLIDER	M6	4031				(*)	
MONSTER 821	14' - 18'	SPOOL	M6	5922				(*)	
MONSTER 821	14' - 18'	SPOOL PRO	M6	9258				(*)	
MONSTER 821	14' - 18'	SPOOL SLIDER	M6	4031				(*)	
MULTIESTRADA 950	17' - 18'	SPOOL	M8	5923				(*)	
MULTIESTRADA 950	17' - 18'	SPOOL PRO	M8	9259				(*)	
MULTIESTRADA 950	17' - 18'	SPOOL SLIDER	M8	7184				(*)	
HONDA									
CBF125	09' - 15'	SPOOL	M8	5923				(*)	
CBF125	09' - 15'	SPOOL PRO	M8	9259				(*)	
CBF125	09' - 15'	SPOOL SLIDER	M8	7184				(*)	
CB300F	15' - 16'	SPOOL	M8	5923				(*)	
CB300F	15' - 16'	SPOOL PRO	M8	9259				(*)	
CB300F	15' - 16'	SPOOL SLIDER	M8	7184				(*)	
CB500F	13' - 18'	SPOOL	M8	5923				(*)	
CB500F	13' - 18'	SPOOL PRO	M8	9259				(*)	
CB500F	13' - 18'	SPOOL SLIDER	M8	7184				(*)	

MODEL	YEAR	TYPE OF SPOOL	SCREW	REF.	
CB500X	13' - 18'	SPOOL	M8	5923	(*)
CB500X	13' - 18'	SPOOL PRO	M8	9259	(*)
CB500X	13' - 18'	SPOOL SLIDER	M8	7184	(*)
CB600F HORNET	05' - 15'	SPOOL	M8	5923	(*)
CB600F HORNET	05' - 15'	SPOOL PRO	M8	9259	(*)
CB600F HORNET	05' - 15'	SPOOL SLIDER	M8	7184	(*)
CB1000R	08' - 16'	SPOOL	M8	5923	(*)
CB1000R	08' - 16'	SPOOL PRO	M8	9259	(*)
CB1000R	08' - 16'	SPOOL SLIDER	M8	7184	(*)
CB1300S	05' - 13'	SPOOL	M8	5923	(*)
CB1300S	05' - 13'	SPOOL PRO	M8	9259	(*)
CB1300S	05' - 13'	SPOOL SLIDER	M8	7184	(*)
CBF600S	04' - 14'	SPOOL	M8	5923	(*)
CBF600S	04' - 14'	SPOOL PRO	M8	9259	(*)
CBF600S	04' - 14'	SPOOL SLIDER	M8	7184	(*)
CBF1000	06' - 11'	SPOOL	M8	5923	(*)
CBF1000	06' - 11'	SPOOL PRO	M8	9259	(*)
CBF1000	06' - 11'	SPOOL SLIDER	M8	7184	(*)
CBF1000F	10' - 16'	SPOOL	M8	5923	(*)
CBF1000F	10' - 16'	SPOOL PRO	M8	9259	(*)
CBF1000F	10' - 16'	SPOOL SLIDER	M8	7184	(*)
CBR600F	95' - 07'	SPOOL	M8	5923	(*)
CBR600F	11' - 13'	SPOOL	M8	5923	(*)
CBR600F	95' - 07'	SPOOL SLIDER	M8	7184	(*)
CBR600F	11' - 13'	SPOOL SLIDER	M8	7184	(*)
CBR600F	95' - 07'	SPOOL PRO	M8	9259	(*)
CBR600F	11' - 13'	SPOOL PRO	M8	9259	(*)
CBR650F	14' - 16'	SPOOL	M8	5923	(*)
CBR650F	14' - 16'	SPOOL PRO	M8	9259	(*)
CBR650F	14' - 16'	SPOOL SLIDER	M8	7184	(*)
CBR125R	07' - 16'	SPOOL	M8	5923	(*)
CBR125R	07' - 16'	SPOOL PRO	M8	9259	(*)
CBR125R	07' - 16'	SPOOL SLIDER	M8	7184	(*)
CBR250R	11' - 15'	SPOOL	M8	5923	(*)
CBR250R	11' - 15'	SPOOL PRO	M8	9259	(*)
CBR250R	11' - 15'	SPOOL SLIDER	M8	7184	(*)
CBR300R	15' - 17'	SPOOL	M8	5923	(*)
CBR300R	15' - 17'	SPOOL PRO	M8	9259	(*)
CBR300R	15' - 17'	SPOOL SLIDER	M8	7184	(*)
CBR500R	13' - 18'	SPOOL	M8	5923	(*)
CBR500R	13' - 18'	SPOOL PRO	M8	9259	(*)
CBR500R	13' - 18'	SPOOL SLIDER	M8	7184	(*)
CBR600RR	03' - 16'	SPOOL	M8	5923	(*)

R
RedA
BlueN
BlackV
GreenP
SilverO
GoldT
OrangeSPOOL
SPOOL PRON
Black NylonSPOOL
SLIDER

Part numbers that appear in the list are compatible with most bikes. Nevertheless, we advise to check the dimensions of OEM piece.

(*) Check price with your distributor.

IMPORTANT: Indicate code color after part#. Example: 0973A.

SPOOLS

HI-TECH PARTS | TYPE OF SPOOL:

2019
MODELS:
www.puig.tv

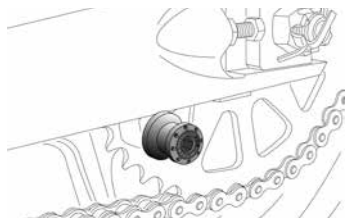

SPOOL



SPOOL SLIDER



SPOOL PRO

MODEL	YEAR	TYPE OF SPOOL	SCREW	REF.	
CBR600RR	03' - 16'	SPOOL PRO	M8	9259	(*)
CBR600RR	03' - 16'	SPOOL SLIDER	M8	7184	(*)
CBR900RR FIRE BLADE	98' - 03'	SPOOL	M8	5923	(*)
CBR900RR FIRE BLADE	98' - 03'	SPOOL PRO	M8	9259	(*)
CBR900RR FIRE BLADE	98' - 03'	SPOOL SLIDER	M8	7184	(*)
CBR1000RR FIRE BLADE	04' - 13'	SPOOL	M8	5923	(*)
CBR1000RR FIRE BLADE	04' - 13'	SPOOL PRO	M8	9259	(*)
CBR1000RR FIRE BLADE	04' - 13'	SPOOL SLIDER	M8	7184	(*)
CBR1000RR FIRE BLADE/SP	14' - 16'	SPOOL	M8	5923	(*)
CBR1000RR FIRE BLADE/SP	14' - 16'	SPOOL PRO	M8	9259	(*)
CBR1000RR FIRE BLADE/SP	14' - 16'	SPOOL SLIDER	M8	7184	(*)
CBR1000RR FIREBLADE/SP/SP2	17' - 18'	SPOOL	M8	5923	(*)
CBR1000RR FIREBLADE/SP/SP2	17' - 18'	SPOOL PRO	M8	9259	(*)
CBR1000RR FIREBLADE/SP/SP2	17' - 18'	SPOOL SLIDER	M8	7184	(*)
CBR1100XX BLACKBIRD	97' - 07'	SPOOL	M8	5923	(*)
CBR1100XX BLACKBIRD	97' - 07'	SPOOL PRO	M8	9259	(*)
CBR1100XX BLACKBIRD	97' - 07'	SPOOL SLIDER	M8	7184	(*)
CRF1000L AFRICA TWIN	16' - 18'	SPOOL	M8	5923	(*)
CRF1000L AFRICA TWIN	16' - 18'	SPOOL PRO	M8	9259	(*)
CRF1000L AFRICA TWIN	16' - 18'	SPOOL SLIDER	M8	7184	(*)
CROSSTOURER	12' - 18'	SPOOL	M8	5923	(*)
CROSSTOURER	12' - 18'	SPOOL PRO	M8	9259	(*)
CROSSTOURER	12' - 18'	SPOOL SLIDER	M8	7184	(*)
CTX700	14' - 16'	SPOOL	M8	5923	(*)
CTX700	14' - 16'	SPOOL PRO	M8	9259	(*)
CTX700	14' - 16'	SPOOL SLIDER	M8	7184	(*)
CTX700N	14' - 16'	SPOOL	M8	5923	(*)
CTX700N	14' - 16'	SPOOL PRO	M8	9259	(*)
CTX700N	14' - 16'	SPOOL SLIDER	M8	7184	(*)
CTX1300	14' - 16'	SPOOL	M8	5923	(*)
CTX1300	14' - 16'	SPOOL PRO	M8	9259	(*)
CTX1300	14' - 16'	SPOOL SLIDER	M8	7184	(*)
NC700S	12' - 13'	SPOOL	M8	5923	(*)
NC700S	12' - 13'	SPOOL PRO	M8	9259	(*)
NC700S	12' - 13'	SPOOL SLIDER	M8	7184	(*)
NC750S	14' - 18'	SPOOL	M8	5923	(*)
NC750S	14' - 18'	SPOOL PRO	M8	9259	(*)
NC750S	14' - 18'	SPOOL SLIDER	M8	7184	(*)

MODEL	YEAR	TYPE OF SPOOL	SCREW	REF.	
NC700X	12' - 13'	SPOOL	M8	5923	(*)
NC700X	12' - 13'	SPOOL PRO	M8	9259	(*)
NC700X	12' - 13'	SPOOL SLIDER	M8	7184	(*)
NC750X	14' -15'	SPOOL	M8	5923	(*)
NC750X	14' -15'	SPOOL PRO	M8	9259	(*)
NC750X	14' -15'	SPOOL SLIDER	M8	7184	(*)
NT650V DEAUVILLE	98' - 05'	SPOOL	M8	5923	(*)
NT650V DEAUVILLE	98' - 05'	SPOOL PRO	M8	9259	(*)
NT650V DEAUVILLE	98' - 05'	SPOOL SLIDER	M8	7184	(*)
NT700V DEAUVILLE	06' - 12'	SPOOL	M8	5923	(*)
NT700V DEAUVILLE	06' - 12'	SPOOL PRO	M8	9259	(*)
NT700V DEAUVILLE	06' - 12'	SPOOL SLIDER	M8	7184	(*)
PAN-EUROPEAN	02' - 13'	SPOOL	M8	5923	(*)
PAN-EUROPEAN	02' - 13'	SPOOL PRO	M8	9259	(*)
PAN-EUROPEAN	02' - 13'	SPOOL SLIDER	M8	7184	(*)
ST1100 PAN EUROPEAN	90' - 01'	SPOOL	M8	5923	(*)
ST1100 PAN EUROPEAN	90' - 01'	SPOOL PRO	M8	9259	(*)
ST1100 PAN EUROPEAN	90' - 01'	SPOOL SLIDER	M8	7184	(*)
VFR800	02' - 13'	SPOOL	M8	5923	(*)
VFR800	02' - 13'	SPOOL PRO	M8	9259	(*)
VFR800	02' - 13'	SPOOL SLIDER	M8	7184	(*)
VFR800F	14' - 18'	SPOOL	M8	5923	(*)
VFR800F	14' - 18'	SPOOL PRO	M8	9259	(*)
VFR800F	14' - 18'	SPOOL SLIDER	M8	7184	(*)
VFR1200F	10' - 16'	SPOOL	M8	5923	(*)
VFR1200F	10' - 16'	SPOOL PRO	M8	9259	(*)
VFR1200F	10' - 16'	SPOOL SLIDER	M8	7184	(*)
VTR1000F FIRE STORM	97' - 07'	SPOOL	M8	5923	(*)
VTR1000F FIRE STORM	97' - 07'	SPOOL PRO	M8	9259	(*)
VTR1000F FIRE STORM	97' - 07'	SPOOL SLIDER	M8	7184	(*)
VTR1000 SP-1	00' - 02'	SPOOL	M8	5923	(*)
VTR1000 SP-1	00' - 02'	SPOOL PRO	M8	9259	(*)
VTR1000 SP-1	00' - 02'	SPOOL SLIDER	M8	7184	(*)
VTR1000 SP-2	02' - 05'	SPOOL	M8	5923	(*)
VTR1000 SP-2	02' - 05'	SPOOL PRO	M8	9259	(*)
VTR1000 SP-2	02' - 05'	SPOOL SLIDER	M8	7184	(*)
XL600V TRANSALP	87' - 93'	SPOOL	M8	5923	(*)
XL600V TRANSALP	87' - 93'	SPOOL PRO	M8	9259	(*)
XL600V TRANSALP	87' - 93'	SPOOL SLIDER	M8	7184	(*)
XL650V TRANSALP	00' - 07'	SPOOL	M8	5923	(*)
XL650V TRANSALP	00' - 07'	SPOOL PRO	M8	9259	(*)
XL650V TRANSALP	00' - 07'	SPOOL SLIDER	M8	7184	(*)
XL1000V VARADERO	99' - 11'	SPOOL	M8	5923	(*)

R
RedA
BlueN
BlackV
GreenP
SilverO
GoldT
OrangeSPOOL
SPOOL PRON
Black NylonSPOOL
SLIDER

Part numbers that appear in the list are compatible with most bikes. Nevertheless, we advise to check the dimensions of OEM piece.

(*) Check price with your distributor.

IMPORTANT: Indicate code color after part#. Example: 0973A.

SPOOLS

HI-TECH PARTS | TYPE OF SPOOL:

2019
MODELS:
www.puig.tv

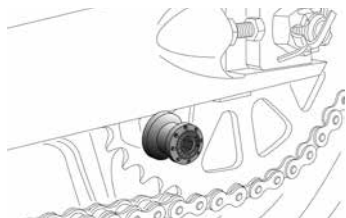

SPOOL

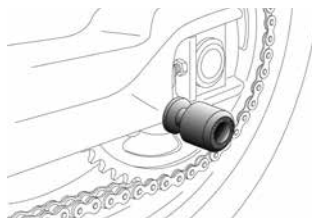

SPOOL SLIDER



SPOOL PRO

MODEL	YEAR	TYPE OF SPOOL	SCREW	REF.	
XL1000V VARADERO	99' - 11'	SPOOL PRO	M8	9259	(*)
XL1000V VARADERO	99' - 11'	SPOOL SLIDER	M8	7184	(*)
KAWASAKI					
ER-6F	06' - 16'	SPOOL	M10/125	5924	(*)
ER-6F	06' - 16'	SPOOL PRO	M10/125	9260	(*)
ER-6F	06' - 16'	SPOOL SLIDER	M10/125	4033	(*)
ER-6N	05' - 16'	SPOOL	M10/125	5924	(*)
ER-6N	05' - 16'	SPOOL PRO	M10/125	9260	(*)
ER-6N	05' - 16'	SPOOL SLIDER	M10/125	4033	(*)
GPX600R	88' - 99'	SPOOL	M10/125	5924	(*)
GPX600R	88' - 99'	SPOOL PRO	M10/125	9260	(*)
GPX600R	88' - 99'	SPOOL SLIDER	M10/125	4033	(*)
GPZ500S	94' - 03'	SPOOL	M10/125	5924	(*)
GPZ500S	94' - 03'	SPOOL PRO	M10/125	9260	(*)
GPZ500S	94' - 03'	SPOOL SLIDER	M10/125	4033	(*)
GTR1400	07' - 18'	SPOOL	M10/125	5924	(*)
GTR1400	07' - 18'	SPOOL PRO	M10/125	9260	(*)
GTR1400	07' - 18'	SPOOL SLIDER	M10/125	4033	(*)
KLE500	96' - 07'	SPOOL	M10/125	5924	(*)
KLE500	96' - 07'	SPOOL PRO	M10/125	9260	(*)
KLE500	96' - 07'	SPOOL SLIDER	M10/125	4033	(*)
KLV1000	04' - 05'	SPOOL	M10/125	5924	(*)
KLV1000	04' - 05'	SPOOL PRO	M10/125	9260	(*)
KLV1000	04' - 05'	SPOOL SLIDER	M10/125	4033	(*)
NINJA 250R	08' - 12'	SPOOL	M10/125	5924	(*)
NINJA 250R	08' - 12'	SPOOL PRO	M10/125	9260	(*)
NINJA 250R	08' - 12'	SPOOL SLIDER	M10/125	4033	(*)
NINJA 250SL	15' - 16'	SPOOL	M8	5923	(*)
NINJA 250SL	15' - 16'	SPOOL PRO	M8	9259	(*)
NINJA 250SL	15' - 16'	SPOOL SLIDER	M8	7184	(*)
NINJA 300	13' - 17'	SPOOL	M8	5923	(*)
NINJA 300	13' - 17'	SPOOL PRO	M8	9259	(*)
NINJA 300	13' - 17'	SPOOL SLIDER	M8	7184	(*)
NINJA 400	18'	SPOOL	M8	5923	(*)
NINJA 400	18'	SPOOL PRO	M8	9259	(*)
NINJA 400	18'	SPOOL SLIDER	M8	7184	(*)
NINJA 650	17' - 18'	SPOOL	M8	5923	(*)
NINJA 650	17' - 18'	SPOOL PRO	M8	9259	(*)

MODEL	YEAR	TYPE OF SPOOL	SCREW	REF.	
NINJA 650	17' - 18'	SPOOL SLIDER	M8	7184	(*)
NINJA H2/H2R	15' - 18'	SPOOL	M8	5923	(*)
NINJA H2/H2R	15' - 18'	SPOOL PRO	M8	9259	(*)
NINJA H2/H2R	15' - 18'	SPOOL SLIDER	M8	7184	(*)
VERSYS 650	07' - 18'	SPOOL	M8	5923	(*)
VERSYS 650	07' - 18'	SPOOL PRO	M8	9259	(*)
VERSYS 650	07' - 18'	SPOOL SLIDER	M8	7184	(*)
VERSYS 1000	12' - 14'	SPOOL	M10/125	5924	(*)
VERSYS 1000	12' - 14'	SPOOL PRO	M10/125	9260	(*)
VERSYS 1000	12' - 14'	SPOOL SLIDER	M10/125	4033	(*)
VULCAN S	15' - 18'	SPOOL	M10/125	5924	(*)
VULCAN S	15' - 18'	SPOOL PRO	M10/125	9260	(*)
VULCAN S	15' - 18'	SPOOL SLIDER	M10/125	4033	(*)
VULCAN S CAFE	17' - 18'	SPOOL	M10/125	5924	(*)
VULCAN S CAFE	17' - 18'	SPOOL PRO	M10/125	9260	(*)
VULCAN S CAFE	17' - 18'	SPOOL SLIDER	M10/125	4033	(*)
Z250SL	15' - 16'	SPOOL	M10/125	5924	(*)
Z250SL	15' - 16'	SPOOL PRO	M10/125	9260	(*)
Z250SL	15' - 16'	SPOOL SLIDER	M10/125	4033	(*)
Z300	15' - 17'	SPOOL	M10/125	5924	(*)
Z300	15' - 17'	SPOOL PRO	M10/125	9260	(*)
Z300	15' - 17'	SPOOL SLIDER	M10/125	4033	(*)
Z650	17' - 18'	SPOOL	M8	5923	(*)
Z650	17' - 18'	SPOOL PRO	M8	9259	(*)
Z650	17' - 18'	SPOOL SLIDER	M8	7184	(*)
Z750S	05' - 06'	SPOOL	M10/125	5924	(*)
Z750S	05' - 06'	SPOOL PRO	M10/125	9260	(*)
Z750S	05' - 06'	SPOOL SLIDER	M10/125	4033	(*)
Z750	07' - 12'	SPOOL	M10/125	5924	(*)
Z750	07' - 12'	SPOOL PRO	M10/125	9260	(*)
Z750	07' - 12'	SPOOL SLIDER	M10/125	4033	(*)
Z750R	11' - 12'	SPOOL	M10/125	5924	(*)
Z750R	11' - 12'	SPOOL PRO	M10/125	9260	(*)
Z750R	11' - 12'	SPOOL SLIDER	M10/125	4033	(*)
Z800/E	13' - 16'	SPOOL	M8	5923	(*)
Z800/E	13' - 16'	SPOOL PRO	M8	9259	(*)
Z800/E	13' - 16'	SPOOL SLIDER	M8	7184	(*)
Z900	17' - 18'	SPOOL	M8	5923	(*)
Z900	17' - 18'	SPOOL PRO	M8	9259	(*)
Z900	17' - 18'	SPOOL SLIDER	M8	7184	(*)
Z900RS	18'	SPOOL	M8	5923	(*)
Z900RS	18'	SPOOL PRO	M8	9259	(*)
Z900RS	18'	SPOOL SLIDER	M8	7184	(*)



R
Red



A
Blue



N
Black



V
Green



P
Silver



O
Gold



T
Orange

SPOOL
SPOOL PRO



N
Black Nylon

SPOOL
SLIDER

Part numbers that appear in the list are compatible with most bikes. Nevertheless, we advise to check the dimensions of OEM piece.

(*) Check price with your distributor.

IMPORTANT: Indicate code color after part#. Example: 0973A.

SPOOLS

HI-TECH PARTS | TYPE OF SPOOL:

2019
MODELS:
www.puig.tv

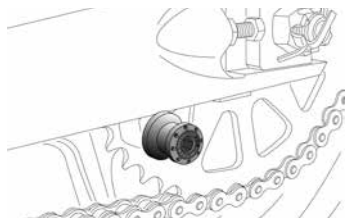

SPOOL



SPOOL SLIDER



SPOOL PRO

MODEL	YEAR	TYPE OF SPOOL	SCREW	REF.	R N	O P	A V	T V
Z1000	03' - 12'	SPOOL	M10/125	5924				*
Z1000	03' - 12'	SPOOL PRO	M10/125	9260				*
Z1000	03' - 12'	SPOOL SLIDER	M10/125	4033				*
Z1000	13' - 18'	SPOOL	M8	5923				*
Z1000	13' - 18'	SPOOL PRO	M8	9259				*
Z1000	13' - 18'	SPOOL SLIDER	M8	7184				*
Z1000SX	11' - 12'	SPOOL	M10/125	5924				*
Z1000SX	11' - 12'	SPOOL PRO	M10/125	9260				*
Z1000SX	11' - 12'	SPOOL SLIDER	M10/125	4033				*
Z1000SX	13' - 18'	SPOOL	M8	5923				*
Z1000SX	13' - 18'	SPOOL PRO	M8	9259				*
Z1000SX	13' - 18'	SPOOL SLIDER	M8	7184				*
ZR7S	01' - 03'	SPOOL	M10/125	5924				*
ZR7S	01' - 03'	SPOOL PRO	M10/125	9260				*
ZR7S	01' - 03'	SPOOL SLIDER	M10/125	4033				*
ZRX1200R	97' - 06'	SPOOL	M10/125	5924				*
ZRX1200R	97' - 06'	SPOOL PRO	M10/125	9260				*
ZRX1200R	97' - 06'	SPOOL SLIDER	M10/125	4033				*
ZRX1200S	01' - 07'	SPOOL	M10/125	5924				*
ZRX1200S	01' - 07'	SPOOL PRO	M10/125	9260				*
ZRX1200S	01' - 07'	SPOOL SLIDER	M10/125	4033				*
ZX-6R	98' - 16'	SPOOL	M10/125	5924				*
ZX-6R	98' - 16'	SPOOL PRO	M10/125	9260				*
ZX-6R	98' - 16'	SPOOL SLIDER	M10/125	4033				*
ZX-6R 636	13' - 16'	SPOOL	M8	5923				*
ZX-6R 636	13' - 16'	SPOOL PRO	M8	9259				*
ZX-6R 636	13' - 16'	SPOOL SLIDER	M8	7184				*
ZX-9R	94' - 04'	SPOOL	M10/125	5924				*
ZX-9R	94' - 04'	SPOOL PRO	M10/125	9260				*
ZX-9R	94' - 04'	SPOOL SLIDER	M10/125	4033				*
ZX-10R	16' - 18'	SPOOL	M8	5923				*
ZX-10R	16' - 18'	SPOOL PRO	M8	9259				*
ZX-10R	16' - 18'	SPOOL SLIDER	M8	7184				*
ZX-12R	00' - 06'	SPOOL	M10/125	5924				*
ZX-12R	00' - 06'	SPOOL PRO	M10/125	9260				*
ZX-12R	00' - 06'	SPOOL SLIDER	M10/125	4033				*
ZZR600	93' - 06'	SPOOL	M10/125	5924				*
ZZR600	93' - 06'	SPOOL PRO	M10/125	9260				*

MODEL	YEAR	TYPE OF SPOOL	SCREW	REF.	
ZZR600	93' - 06'	SPOOL SLIDER	M10/125	4033	(*)
ZZR1200	02' - 05'	SPOOL	M10/125	5924	(*)
ZZR1200	02' - 05'	SPOOL PRO	M10/125	9260	(*)
ZZR1200	02' - 05'	SPOOL SLIDER	M10/125	4033	(*)
ZZR1400	06' - 18'	SPOOL	M10/125	5924	(*)
ZZR1400	06' - 18'	SPOOL PRO	M10/125	9260	(*)
ZZR1400	06' - 18'	SPOOL SLIDER	M10/125	4033	(*)
KTM					
125 DUKE	11' - 18'	SPOOL	M10/150	5988	(*)
125 DUKE	11' - 18'	SPOOL PRO	M10/150	9261	(*)
125 DUKE	11' - 18'	SPOOL SLIDER	M10/150	7185	(*)
200 DUKE	12 - 15'	SPOOL	M10/150	5988	(*)
200 DUKE	12 - 15'	SPOOL PRO	M10/150	9261	(*)
200 DUKE	12 - 15'	SPOOL SLIDER	M10/150	7185	(*)
390 DUKE	13' - 18'	SPOOL	M10/150	5988	(*)
390 DUKE	13' - 18'	SPOOL PRO	M10/150	9261	(*)
390 DUKE	13' - 18'	SPOOL SLIDER	M10/150	7185	(*)
690 DUKE	08' - 18'	SPOOL	M10/150	5988	(*)
690 DUKE	08' - 18'	SPOOL PRO	M10/150	9261	(*)
690 DUKE	08' - 18'	SPOOL SLIDER	M10/150	7185	(*)
690 DUKE R	10' - 17'	SPOOL	M10/150	5988	(*)
690 DUKE R	10' - 17'	SPOOL PRO	M10/150	9261	(*)
690 DUKE R	10' - 17'	SPOOL SLIDER	M10/150	7185	(*)
690 SUPERMOTO	07' - 11'	SPOOL	M10/150	5988	(*)
690 SUPERMOTO	07' - 11'	SPOOL PRO	M10/150	9261	(*)
690 SUPERMOTO	07' - 11'	SPOOL SLIDER	M10/150	7185	(*)
690 SUPERMOTO SMC R	12' - 17'	SPOOL	M10/150	5988	(*)
690 SUPERMOTO SMC R	12' - 17'	SPOOL PRO	M10/150	9261	(*)
690 SUPERMOTO SMC R	12' - 17'	SPOOL SLIDER	M10/150	7185	(*)
790 DUKE	18'	SPOOL	M10/150	5988	(*)
790 DUKE	18'	SPOOL PRO	M10/150	9261	(*)
790 DUKE	18'	SPOOL SLIDER	M10/150	7185	(*)
950 SUPERMOTO	05' - 07'	SPOOL	M10/150	5988	(*)
950 SUPERMOTO	05' - 07'	SPOOL PRO	M10/150	9261	(*)
950 SUPERMOTO	05' - 07'	SPOOL SLIDER	M10/150	7185	(*)
950 SUPERMOTO R	07' - 08'	SPOOL	M10/150	5988	(*)
950 SUPERMOTO R	07' - 08'	SPOOL PRO	M10/150	9261	(*)
950 SUPERMOTO R	07' - 08'	SPOOL SLIDER	M10/150	7185	(*)
950 SUPERENDURO	06' - 09'	SPOOL	M10/150	5988	(*)
950 SUPERENDURO	06' - 09'	SPOOL PRO	M10/150	9261	(*)
950 SUPERENDURO	06' - 09'	SPOOL SLIDER	M10/150	7185	(*)
990 SUPERDUKE/R	07' - 13'	SPOOL	M10/150	5988	(*)
990 SUPERDUKE/R	07' - 13'	SPOOL PRO	M10/150	9261	(*)



R
Red



A
Blue



N
Black



V
Green



P
Silver



O
Gold



T
Orange

**SPOOL
SPOOL PRO**



N
Black Nylon

**SPOOL
SLIDER**

Part numbers that appear in the list are compatible with most bikes. Nevertheless, we advise to check the dimensions of OEM piece.

(*) Check price with your distributor.

IMPORTANT: Indicate code color after part#. Example: 0973A.

SPOOLS

HI-TECH PARTS | TYPE OF SPOOL:

2019
MODELS:
www.puig.tv

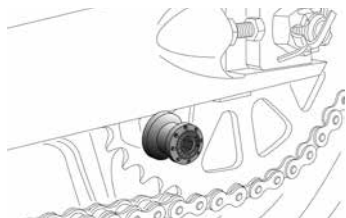

SPOOL

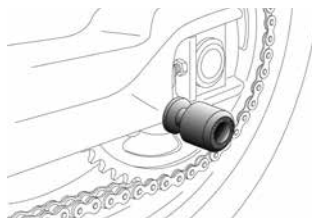

SPOOL SLIDER



SPOOL PRO

MODEL	YEAR	TYPE OF SPOOL	SCREW	REF.	R O A T N P V
990 SUPERDUKE/R	07' - 13'	SPOOL SLIDER	M10/150	7185	(*)
990 SUPERMOTO	08' - 13'	SPOOL	M10/150	5988	(*)
990 SUPERMOTO	08' - 13'	SPOOL PRO	M10/150	9261	(*)
990 SUPERMOTO	08' - 13'	SPOOL SLIDER	M10/150	7185	(*)
990 SUPERMOTO R	09' - 13'	SPOOL	M10/150	5988	(*)
990 SUPERMOTO R	09' - 13'	SPOOL PRO	M10/150	9261	(*)
990 SUPERMOTO R	09' - 13'	SPOOL SLIDER	M10/150	7185	(*)
990 SUPERMOTO T	09' - 12'	SPOOL	M10/150	5988	(*)
990 SUPERMOTO T	09' - 12'	SPOOL PRO	M10/150	9261	(*)
990 SUPERMOTO T	09' - 12'	SPOOL SLIDER	M10/150	7185	(*)
1050 ADVENTURE	15' - 16'	SPOOL	M10/150	5988	(*)
1050 ADVENTURE	15' - 16'	SPOOL PRO	M10/150	9261	(*)
1050 ADVENTURE	15' - 16'	SPOOL SLIDER	M10/150	7185	(*)
1090 ADVENTURE/R	17' - 18'	SPOOL	M10/150	5988	(*)
1090 ADVENTURE/R	17' - 18'	SPOOL PRO	M10/150	9261	(*)
1090 ADVENTURE/R	17' - 18'	SPOOL SLIDER	M10/150	7185	(*)
1190 ADVENTURE/R	13' - 16'	SPOOL	M10/150	5988	(*)
1190 ADVENTURE/R	13' - 16'	SPOOL PRO	M10/150	9261	(*)
1190 ADVENTURE/R	13' - 16'	SPOOL SLIDER	M10/150	7185	(*)
1190 RC8/R	08' - 15'	SPOOL	M10/150	5988	(*)
1190 RC8/R	08' - 15'	SPOOL PRO	M10/150	9261	(*)
1190 RC8/R	08' - 15'	SPOOL SLIDER	M10/150	7185	(*)
1290 SUPERDUKE R	14' - 16'	SPOOL	M10/150	5988	(*)
1290 SUPERDUKE R	14' - 16'	SPOOL PRO	M10/150	9261	(*)
1290 SUPERDUKE R	14' - 16'	SPOOL SLIDER	M10/150	7185	(*)
1290 SUPER ADVENTURE	15' - 16'	SPOOL	M10/150	5988	(*)
1290 SUPER ADVENTURE	15' - 16'	SPOOL PRO	M10/150	9261	(*)
1290 SUPER ADVENTURE	15' - 16'	SPOOL SLIDER	M10/150	7185	(*)
1290 SUPER ADVENTURE T	17'	SPOOL	M10/150	5988	(*)
1290 SUPER ADVENTURE T	17'	SPOOL PRO	M10/150	9261	(*)
1290 SUPER ADVENTURE T	17'	SPOOL SLIDER	M10/150	7185	(*)
1290 SUPER ADVENTURE R	17' - 18'	SPOOL	M10/150	5988	(*)
1290 SUPER ADVENTURE R	17' - 18'	SPOOL PRO	M10/150	9261	(*)
1290 SUPER ADVENTURE R	17' - 18'	SPOOL SLIDER	M10/150	7185	(*)
1290 SUPER ADVENTURE S	17' - 18'	SPOOL	M10/150	5988	(*)
1290 SUPER ADVENTURE S	17' - 18'	SPOOL PRO	M10/150	9261	(*)
1290 SUPER ADVENTURE S	17' - 18'	SPOOL SLIDER	M10/150	7185	(*)
RC125/RC390	14' - 18'	SPOOL	M10/125	5924	(*)

MODEL	YEAR	TYPE OF SPOOL	SCREW	REF.	
RC125/RC390	14' - 18'	SPOOL PRO	M10/125	9260	(*)
RC125/RC390	14' - 18'	SPOOL SLIDER	M10/125	4033	(*)
SUZUKI					
B-KING	08' - 11'	SPOOL	M8	5923	(*)
B-KING	08' - 11'	SPOOL PRO	M8	9259	(*)
B-KING	08' - 11'	SPOOL SLIDER	M8	7184	(*)
DL250 V-STROM	17' - 18'	SPOOL	M8	5923	(*)
DL250 V-STROM	17' - 18'	SPOOL PRO	M8	9259	(*)
DL250 V-STROM	17' - 18'	SPOOL SLIDER	M8	7184	(*)
DL650 V-STROM	04' - 18'	SPOOL	M8	5923	(*)
DL650 V-STROM	04' - 18'	SPOOL PRO	M8	9259	(*)
DL650 V-STROM	04' - 18'	SPOOL SLIDER	M8	7184	(*)
DL650XT V-STROM	15' -18'	SPOOL	M8	5923	(*)
DL650XT V-STROM	15' -18'	SPOOL PRO	M8	9259	(*)
DL650XT V-STROM	15' -18'	SPOOL SLIDER	M8	7184	(*)
DL1000 V-STROM	02' - 07'	SPOOL	M8	5923	(*)
DL1000 V-STROM	14' - 18'	SPOOL	M8	5923	(*)
DL1000 V-STROM	02' - 07'	SPOOL PRO	M8	9259	(*)
DL1000 V-STROM	14' - 18'	SPOOL PRO	M8	9259	(*)
DL1000 V-STROM	02' - 07'	SPOOL SLIDER	M8	7184	(*)
DL1000 V-STROM	14' - 18'	SPOOL SLIDER	M8	7184	(*)
DL1000XT V-STROM	17' - 18'	SPOOL	M8	5923	(*)
DL1000XT V-STROM	17' - 18'	SPOOL PRO	M8	9259	(*)
DL1000XT V-STROM	17' - 18'	SPOOL SLIDER	M8	7184	(*)
DR800	91' - 99'	SPOOL	M8	5923	(*)
DR800	91' - 99'	SPOOL PRO	M8	9259	(*)
DR800	91' - 99'	SPOOL SLIDER	M8	7184	(*)
GS500F	04' - 07'	SPOOL	M8	5923	(*)
GS500F	04' - 07'	SPOOL PRO	M8	9259	(*)
GS500F	04' - 07'	SPOOL SLIDER	M8	7184	(*)
GSF600S BANDIT	96' - 04'	SPOOL	M8	5923	(*)
GSF600S BANDIT	96' - 04'	SPOOL PRO	M8	9259	(*)
GSF600S BANDIT	96' - 04'	SPOOL SLIDER	M8	7184	(*)
GSF650 BANDIT	09' - 11'	SPOOL	M8	5923	(*)
GSF650 BANDIT	09' - 11'	SPOOL PRO	M8	9259	(*)
GSF650 BANDIT	09' - 11'	SPOOL SLIDER	M8	7184	(*)
GSF650S BANDIT	05' - 08'	SPOOL	M8	5923	(*)
GSF650S BANDIT	05' - 08'	SPOOL PRO	M8	9259	(*)
GSF650S BANDIT	05' - 08'	SPOOL SLIDER	M8	7184	(*)
GSF650S BANDIT	05' - 14'	SPOOL	M8	5923	(*)
GSF650S BANDIT	05' - 14'	SPOOL PRO	M8	9259	(*)
GSF650S BANDIT	05' - 14'	SPOOL SLIDER	M8	7184	(*)
GSF1200S BANDIT	96' - 06'	SPOOL	M8	5923	(*)

R
RedA
BlueN
BlackV
GreenP
SilverO
GoldT
OrangeSPOOL
SPOOL PRON
Black NylonSPOOL
SLIDER

Part numbers that appear in the list are compatible with most bikes. Nevertheless, we advise to check the dimensions of OEM piece.

(*) Check price with your distributor.

IMPORTANT: Indicate code color after part#. Example: 0973A.

SPOOLS

HI-TECH PARTS | TYPE OF SPOOL:

2019
MODELS:
www.puig.tv

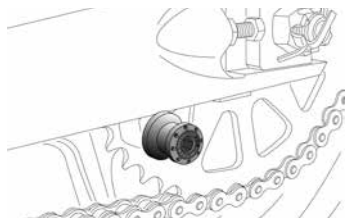

SPOOL



SPOOL SLIDER



SPOOL PRO

MODEL	YEAR	TYPE OF SPOOL	SCREW	REF.	
GSF1200S BANDIT	96' - 06'	SPOOL PRO	M8	9259	(*)
GSF1200S BANDIT	96' - 06'	SPOOL SLIDER	M8	7184	(*)
GSF1250 BANDIT	10' - 13'	SPOOL	M8	5923	(*)
GSF1250 BANDIT	10' - 13'	SPOOL PRO	M8	9259	(*)
GSF1250 BANDIT	10' - 13'	SPOOL SLIDER	M8	7184	(*)
GSF1250S BANDIT	07' - 17'	SPOOL	M8	5923	(*)
GSF1250S BANDIT	07' - 17'	SPOOL PRO	M8	9259	(*)
GSF1250S BANDIT	07' - 17'	SPOOL SLIDER	M8	7184	(*)
GSR600	06' - 11'	SPOOL	M8	5923	(*)
GSR600	06' - 11'	SPOOL PRO	M8	9259	(*)
GSR600	06' - 11'	SPOOL SLIDER	M8	7184	(*)
GSR750	11' - 16'	SPOOL	M8	5923	(*)
GSR750	11' - 16'	SPOOL PRO	M8	9259	(*)
GSR750	11' - 16'	SPOOL SLIDER	M8	7184	(*)
GSX650F	08' - 17'	SPOOL	M8	5923	(*)
GSX650F	08' - 17'	SPOOL PRO	M8	9259	(*)
GSX650F	08' - 17'	SPOOL SLIDER	M8	7184	(*)
GSX1250F	10' - 17'	SPOOL	M8	5923	(*)
GSX1250F	10' - 17'	SPOOL PRO	M8	9259	(*)
GSX1250F	10' - 17'	SPOOL SLIDER	M8	7184	(*)
GSX-R125	17' - 18'	SPOOL	M8	5923	(*)
GSX-R125	17' - 18'	SPOOL PRO	M8	9259	(*)
GSX-R125	17' - 18'	SPOOL SLIDER	M8	7184	(*)
GSX-R250	17' - 18'	SPOOL	M8	5923	(*)
GSX-R250	17' - 18'	SPOOL PRO	M8	9259	(*)
GSX-R250	17' - 18'	SPOOL SLIDER	M8	7184	(*)
GSX-R600	98' - 17'	SPOOL	M8	5923	(*)
GSX-R600	98' - 17'	SPOOL PRO	M8	9259	(*)
GSX-R600	98' - 17'	SPOOL SLIDER	M8	7184	(*)
GSX-R750	96' - 17'	SPOOL	M8	5923	(*)
GSX-R750	96' - 17'	SPOOL PRO	M8	9259	(*)
GSX-R750	96' - 17'	SPOOL SLIDER	M8	7184	(*)
GSX-R1000	01' - 16'	SPOOL	M8	5923	(*)
GSX-R1000	01' - 16'	SPOOL PRO	M8	9259	(*)
GSX-R1000	01' - 16'	SPOOL SLIDER	M8	7184	(*)
GSX-R1000/R	17' - 18'	SPOOL	M8	5923	(*)
GSX-R1000/R	17' - 18'	SPOOL PRO	M8	9259	(*)
GSX-R1000/R	17' - 18'	SPOOL SLIDER	M8	7184	(*)

MODEL	YEAR	TYPE OF SPOOL	SCREW	REF.	
GSX-R1300 HAYABUSA	99' - 17'	SPOOL	M8	5923	(*)
GSX-R1300 HAYABUSA	99' - 17'	SPOOL PRO	M8	9259	(*)
GSX-R1300 HAYABUSA	99' - 17'	SPOOL SLIDER	M8	7184	(*)
GSX-S125	17' - 18'	SPOOL	M8	5923	(*)
GSX-S125	17' - 18'	SPOOL PRO	M8	9259	(*)
GSX-S125	17' - 18'	SPOOL SLIDER	M8	7184	(*)
GSX-S750	17' - 18'	SPOOL	M8	5923	(*)
GSX-S750	17' - 18'	SPOOL PRO	M8	9259	(*)
GSX-S750	17' - 18'	SPOOL SLIDER	M8	7184	(*)
GSX-S1000	15' - 18'	SPOOL	M8	5923	(*)
GSX-S1000	15' - 18'	SPOOL PRO	M8	9259	(*)
GSX-S1000	15' - 18'	SPOOL SLIDER	M8	7184	(*)
GSX-S1000F	15' - 18'	SPOOL	M8	5923	(*)
GSX-S1000F	15' - 18'	SPOOL PRO	M8	9259	(*)
GSX-S1000F	15' - 18'	SPOOL SLIDER	M8	7184	(*)
INAZUMA	13' - 17'	SPOOL	M8	5923	(*)
INAZUMA	13' - 17'	SPOOL PRO	M8	9259	(*)
INAZUMA	13' - 17'	SPOOL SLIDER	M8	7184	(*)
INAZUMA F	15' - 17'	SPOOL	M8	5923	(*)
INAZUMA F	15' - 17'	SPOOL PRO	M8	9259	(*)
INAZUMA F	15' - 17'	SPOOL SLIDER	M8	7184	(*)
RF600	93' - 99'	SPOOL	M8	5923	(*)
RF600	93' - 99'	SPOOL PRO	M8	9259	(*)
RF600	93' - 99'	SPOOL SLIDER	M8	7184	(*)
RF900R	93' - 99'	SPOOL	M8	5923	(*)
RF900R	93' - 99'	SPOOL PRO	M8	9259	(*)
RF900R	93' - 99'	SPOOL SLIDER	M8	7184	(*)
SFV650 GLADIUS	09' - 15'	SPOOL	M8	5923	(*)
SFV650 GLADIUS	09' - 15'	SPOOL PRO	M8	9259	(*)
SFV650 GLADIUS	09' - 15'	SPOOL SLIDER	M8	7184	(*)
SV650	05' - 08'	SPOOL	M8	5923	(*)
SV650	05' - 08'	SPOOL PRO	M8	9259	(*)
SV650	05' - 08'	SPOOL SLIDER	M8	7184	(*)
SV650S	99' - 08	SPOOL	M8	5923	(*)
SV650S	99' - 08	SPOOL PRO	M8	9259	(*)
SV650S	99' - 08	SPOOL SLIDER	M8	7184	(*)
SV650X	18'	SPOOL	M8	5923	(*)
SV650X	18'	SPOOL PRO	M8	9259	(*)
SV650X	18'	SPOOL SLIDER	M8	7184	(*)
SV1000	03' - 05'	SPOOL	M8	5923	(*)
SV1000	03' - 05'	SPOOL PRO	M8	9259	(*)
SV1000	03' - 05'	SPOOL SLIDER	M8	7184	(*)
SV1000S	03' - 05'	SPOOL	M8	5923	(*)

R
RedA
BlueN
BlackV
GreenP
SilverO
GoldT
OrangeSPOOL
SPOOL PRON
Black NylonSPOOL
SLIDER

Part numbers that appear in the list are compatible with most bikes. Nevertheless, we advise to check the dimensions of OEM piece.

(*) Check price with your distributor.

IMPORTANT: Indicate code color after part#. Example: 0973A.

/// SPOOLS

HI-TECH PARTS | TYPE OF SPOOL:

2019
MODELS:
www.puig.tv

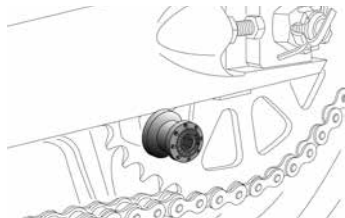

SPOOL



SPOOL SLIDER

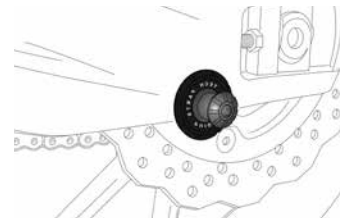

SPOOL PRO

MODEL	YEAR	TYPE OF SPOOL	SCREW	REF.	R N	O P	A V	T V
SV1000S	03' - 05'	SPOOL PRO	M8	9259				*
SV1000S	03' - 05'	SPOOL SLIDER	M8	7184				*
TL1000R	98' - 99'	SPOOL	M8	5923				*
TL1000R	98' - 99'	SPOOL PRO	M8	9259				*
TL1000R	98' - 99'	SPOOL SLIDER	M8	7184				*
TRIUMPH								
DAYTONA 600	03' - 04'	SPOOL	M6	5922				*
DAYTONA 600	03' - 04'	SPOOL PRO	M6	9258				*
DAYTONA 600	03' - 04'	SPOOL SLIDER	M6	4031				*
DAYTONA 650	05'	SPOOL	M6	5922				*
DAYTONA 650	05'	SPOOL PRO	M6	9258				*
DAYTONA 650	05'	SPOOL SLIDER	M6	4031				*
DAYTONA 675	06' - 09'	SPOOL	M6	5922				*
DAYTONA 675	06' - 09'	SPOOL PRO	M6	9258				*
DAYTONA 675	06' - 09'	SPOOL SLIDER	M6	4031				*
DAYTONA 675	10' - 12'	SPOOL	M8	5923				*
DAYTONA 675	10' - 12'	SPOOL PRO	M8	9259				*
DAYTONA 675	10' - 12'	SPOOL SLIDER	M8	7184				*
DAYTONA 675	13' - 16'	SPOOL	M8	5923				*
DAYTONA 675	13' - 16'	SPOOL PRO	M8	9259				*
DAYTONA 675	13' - 16'	SPOOL SLIDER	M8	7184				*
DAYTONA 675 R	11' - 16'	SPOOL	M8	5923				*
DAYTONA 675 R	11' - 16'	SPOOL PRO	M8	9259				*
DAYTONA 675 R	11' - 16'	SPOOL SLIDER	M8	7184				*
DAYTONA 955i	01' - 03'	SPOOL	M6	5922				*
DAYTONA 955i	01' - 03'	SPOOL PRO	M6	9258				*
DAYTONA 955i	01' - 03'	SPOOL SLIDER	M6	4031				*
SPEED TRIPLE	05' - 09'	SPOOL	M6	5922				*
SPEED TRIPLE	05' - 09'	SPOOL PRO	M6	9258				*
SPEED TRIPLE	05' - 09'	SPOOL SLIDER	M6	4031				*
SPEED TRIPLE	10' - 18'	SPOOL	M8	5923				*
SPEED TRIPLE	10' - 18'	SPOOL PRO	M8	9259				*
SPEED TRIPLE	10' - 18'	SPOOL SLIDER	M8	7184				*
SPEED TRIPLE R	12' - 15'	SPOOL	M8	5923				*
SPEED TRIPLE R	12' - 15'	SPOOL PRO	M8	9259				*
SPEED TRIPLE R	12' - 15'	SPOOL SLIDER	M8	7184				*
STREET TRIPLE	07' - 09'	SPOOL	M6	5922				*
STREET TRIPLE	07' - 09'	SPOOL PRO	M6	9258				*

MODEL	YEAR	TYPE OF SPOOL	SCREW	REF.	
STREET TRIPLE	07' - 09'	SPOOL SLIDER	M6	4031	(*)
STREET TRIPLE	10' - 18'	SPOOL	M8	5923	(*)
STREET TRIPLE	10' - 18'	SPOOL PRO	M8	9259	(*)
STREET TRIPLE	10' - 18'	SPOOL SLIDER	M8	7184	(*)
STREET TRIPLE R	09'	SPOOL	M6	5922	(*)
STREET TRIPLE R	09'	SPOOL PRO	M6	9258	(*)
STREET TRIPLE R	09'	SPOOL SLIDER	M6	4031	(*)
STREET TRIPLE R	10' - 18'	SPOOL	M8	5923	(*)
STREET TRIPLE R	10' - 18'	SPOOL PRO	M8	9259	(*)
STREET TRIPLE R	10' - 18'	SPOOL SLIDER	M8	7184	(*)
STREET TRIPLE RS	17' -18'	SPOOL	M8	5923	(*)
STREET TRIPLE RS	17' -18'	SPOOL PRO	M8	9259	(*)
STREET TRIPLE RS	17' -18'	SPOOL SLIDER	M8	7184	(*)
STREET TRIPLE S	17' -18'	SPOOL	M8	5923	(*)
STREET TRIPLE S	17' -18'	SPOOL PRO	M8	9259	(*)
STREET TRIPLE S	17' -18'	SPOOL SLIDER	M8	7184	(*)
TIGER 1050	07' - 09'	SPOOL	M6	5922	(*)
TIGER 1050	07' - 09'	SPOOL PRO	M6	9258	(*)
TIGER 1050	07' - 09'	SPOOL SLIDER	M6	4031	(*)
TIGER 1050	10' - 13'	SPOOL	M8	5923	(*)
TIGER 1050	10' - 13'	SPOOL PRO	M8	9259	(*)
TIGER 1050	10' - 13'	SPOOL SLIDER	M8	7184	(*)
TIGER SPORT	13' - 18'	SPOOL	M8	5923	(*)
TIGER SPORT	13' - 18'	SPOOL PRO	M8	9259	(*)
TIGER SPORT	13' - 18'	SPOOL SLIDER	M8	7184	(*)
TIGER 800/ XC	11' - 14'	SPOOL	M8	5923	(*)
TIGER 800/XC	11' - 14'	SPOOL PRO	M8	9259	(*)
TIGER 800/XC	11' - 14'	SPOOL SLIDER	M8	7184	(*)
TIGER 800 XC/XCX/XCA/XR/XRX/XRT	15' - 17'	SPOOL	M8	5923	(*)
TIGER 800 XC/XCX/XCA/XR/XRX/XRT	15' - 17'	SPOOL PRO	M8	9259	(*)
TIGER 800 XC/XCX/XCA/XR/XRX/XRT	15' - 17'	SPOOL SLIDER	M8	7184	(*)
TIGER EXPLORER	12' - 15'	SPOOL	M8	5923	(*)
TIGER EXPLORER	12' - 15'	SPOOL PRO	M8	9259	(*)
TIGER EXPLORER	12' - 15'	SPOOL SLIDER	M8	7184	(*)
TIGER EXPLORER XC	13' - 15'	SPOOL	M8	5923	(*)
TIGER EXPLORER XC	13' - 15'	SPOOL PRO	M8	9259	(*)
TIGER EXPLORER XC	13' - 15'	SPOOL SLIDER	M8	7184	(*)
TIGER EXPLORER XC/XR/XRX/XRT/XCX/XCA	16' - 18'	SPOOL	M8	5923	(*)
TIGER EXPLORER XC/XR/XRX/XRT/XCX/XCA	16' - 18'	SPOOL PRO	M8	9259	(*)
TIGER EXPLORER XC/XR/XRX/XRT/XCX/XCA	16' - 18'	SPOOL SLIDER	M8	7184	(*)
YAMAHA					
FJR1300	01' - 05'	SPOOL	M6	5922	(*)
FJR1300	01' - 05'	SPOOL PRO	M6	9258	(*)

R
RedA
BlueN
BlackV
GreenP
SilverO
GoldT
OrangeSPOOL
SPOOL PRON
Black NylonSPOOL
SLIDER

Part numbers that appear in the list are compatible with most bikes. Nevertheless, we advise to check the dimensions of OEM piece.

(*) Check price with your distributor.

IMPORTANT: Indicate code color after part#. Example: 0973A.

SPOOLS

HI-TECH PARTS | TYPE OF SPOOL:

2019
MODELS:
www.puig.tv

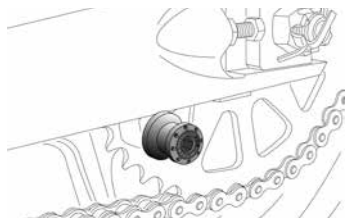

SPOOL



SPOOL SLIDER



SPOOL PRO

MODEL	YEAR	TYPE OF SPOOL	SCREW	REF.	R N	O P	A V	T V
FJR1300	01' - 05'	SPOOL SLIDER	M6	4031				(*)
FJR1300A/AS	06' - 18'	SPOOL	M6	5922				(*)
FJR1300A/AS	06' - 18'	SPOOL PRO	M6	9258				(*)
FJR1300A/AS	06' - 18'	SPOOL SLIDER	M6	4031				(*)
FZ6	04' - 08'	SPOOL	M6	5922				(*)
FZ6	04' - 08'	SPOOL PRO	M6	9258				(*)
FZ6	04' - 08'	SPOOL SLIDER	M6	4031				(*)
FZ6 S2	07' - 10'	SPOOL	M6	5922				(*)
FZ6 S2	07' - 10'	SPOOL PRO	M6	9258				(*)
FZ6 S2	07' - 10'	SPOOL SLIDER	M6	4031				(*)
FZ6 FAZER	04' - 08'	SPOOL	M6	5922				(*)
FZ6 FAZER	04' - 08'	SPOOL PRO	M6	9258				(*)
FZ6 FAZER	04' - 08'	SPOOL SLIDER	M6	4031				(*)
FZ6 FAZER S2	07' - 10'	SPOOL	M6	5922				(*)
FZ6 FAZER S2	07' - 10'	SPOOL PRO	M6	9258				(*)
FZ6 FAZER S2	07' - 10'	SPOOL SLIDER	M6	4031				(*)
FZ750	87' - 95'	SPOOL	M6	5922				(*)
FZ750	87' - 95'	SPOOL PRO	M6	9258				(*)
FZ750	87' - 95'	SPOOL SLIDER	M6	4031				(*)
FZ8	10' - 16'	SPOOL	M6	5922				(*)
FZ8	10' - 16'	SPOOL PRO	M6	9258				(*)
FZ8	10' - 16'	SPOOL SLIDER	M6	4031				(*)
FZ8 FAZER	10' - 12'	SPOOL	M6	5922				(*)
FZ8 FAZER	10' - 12'	SPOOL PRO	M6	9258				(*)
FZ8 FAZER	10' - 12'	SPOOL SLIDER	M6	4031				(*)
FAZER8	13' - 16'	SPOOL	M6	5922				(*)
FAZER8	13' - 16'	SPOOL PRO	M6	9258				(*)
FAZER8	13' - 16'	SPOOL SLIDER	M6	4031				(*)
FZ1	06' - 15'	SPOOL	M6	5922				(*)
FZ1	06' - 15'	SPOOL PRO	M6	9258				(*)
FZ1	06' - 15'	SPOOL SLIDER	M6	4031				(*)
FZ1 FAZER	06' - 15'	SPOOL	M6	5922				(*)
FZ1 FAZER	06' - 15'	SPOOL PRO	M6	9258				(*)
FZ1 FAZER	06' - 15'	SPOOL SLIDER	M6	4031				(*)
FZS600 FAZER	98' - 04'	SPOOL	M6	5922				(*)
FZS600 FAZER	98' - 04'	SPOOL PRO	M6	9258				(*)
FZS600 FAZER	98' - 04'	SPOOL SLIDER	M6	4031				(*)
FZS1000 FAZER	01' - 05'	SPOOL	M6	5922				(*)

MODEL	YEAR	TYPE OF SPOOL	SCREW	REF.	
FZS1000 FAZER	01' - 05'	SPOOL PRO	M6	9258	(*)
FZS1000 FAZER	01' - 05'	SPOOL SLIDER	M6	4031	(*)
MT-125	14' - 18'	SPOOL	M6	5922	(*)
MT-125	14' - 18'	SPOOL PRO	M6	9258	(*)
MT-125	14' - 18'	SPOOL SLIDER	M6	4031	(*)
MT-03	16' - 18'	SPOOL	M6	5922	(*)
MT-03	16' - 18'	SPOOL PRO	M6	9258	(*)
MT-03	16' - 18'	SPOOL SLIDER	M6	4031	(*)
MT-07 TRACER	16' - 18'	SPOOL	M6	5922	(*)
MT-07 TRACER	16' - 18'	SPOOL PRO	M6	9258	(*)
MT-07 TRACER	16' - 18'	SPOOL SLIDER	M6	4031	(*)
MT-09	13' - 18'	SPOOL	M6	5922	(*)
MT-09	13' - 18'	SPOOL PRO	M6	9258	(*)
MT-09	13' - 18'	SPOOL SLIDER	M6	4031	(*)
MT-09 SP	18'	SPOOL	M6	5922	(*)
MT-09 SP	18'	SPOOL PRO	M6	9258	(*)
MT-09 SP	18'	SPOOL SLIDER	M6	4031	(*)
MT-09 TRACER	15' - 18'	SPOOL	M6	5922	(*)
MT-09 TRACER	15' - 18'	SPOOL PRO	M6	9258	(*)
MT-09 TRACER	15' - 18'	SPOOL SLIDER	M6	4031	(*)
MT-09 TRACER GT	18'	SPOOL	M6	5922	(*)
MT-09 TRACER GT	18'	SPOOL PRO	M6	9258	(*)
MT-09 TRACER GT	18'	SPOOL SLIDER	M6	4031	(*)
MT-10	16' - 18'	SPOOL	M6	5922	(*)
MT-10	16' - 18'	SPOOL PRO	M6	9258	(*)
MT-10	16' - 18'	SPOOL SLIDER	M6	4031	(*)
MT-10 SP	17' - 18'	SPOOL	M6	5922	(*)
MT-10 SP	17' - 18'	SPOOL PRO	M6	9258	(*)
MT-10 SP	17' - 18'	SPOOL SLIDER	M6	4031	(*)
XSR900	16' - 18'	SPOOL	M6	5922	(*)
XSR900	16' - 18'	SPOOL PRO	M6	9258	(*)
XSR900	16' - 18'	SPOOL SLIDER	M6	4031	(*)
TDM 900	02' - 13'	SPOOL	M6	5922	(*)
TDM 900	02' - 13'	SPOOL PRO	M6	9258	(*)
TDM 900	02' - 13'	SPOOL SLIDER	M6	4031	(*)
TZR50	98' - 16'	SPOOL	M6	5922	(*)
TZR50	98' - 16'	SPOOL PRO	M6	9258	(*)
TZR50	98' - 16'	SPOOL SLIDER	M6	4031	(*)
TZR80	98' - 02'	SPOOL	M6	5922	(*)
TZR80	98' - 02'	SPOOL PRO	M6	9258	(*)
TZR80	98' - 02'	SPOOL SLIDER	M6	4031	(*)
VMAX	09' - 17'	SPOOL	M6	5922	(*)
VMAX	09' - 17'	SPOOL PRO	M6	9258	(*)

R
RedA
BlueN
BlackV
GreenP
SilverO
GoldT
OrangeSPOOL
SPOOL PRON
Black NylonSPOOL
SLIDER

Part numbers that appear in the list are compatible with most bikes. Nevertheless, we advise to check the dimensions of OEM piece.

(*) Check price with your distributor.

IMPORTANT: Indicate code color after part#. Example: 0973A.

SPOOLS

HI-TECH PARTS | TYPE OF SPOOL:

2019
MODELS:
www.puig.tv

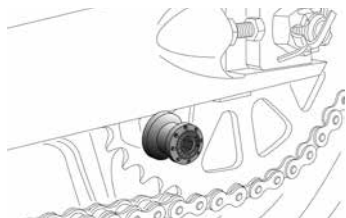

SPOOL



SPOOL SLIDER

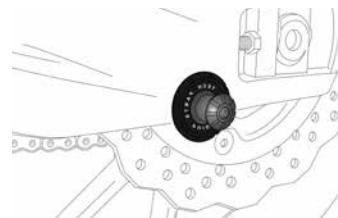

SPOOL PRO

MODEL	YEAR	TYPE OF SPOOL	SCREW	REF.	R N	O P	A V	T V
VMAX	09' - 17'	SPOOL SLIDER	M6	4031				*
XJ600	90' - 03'	SPOOL	M6	5922				*
XJ600	90' - 03'	SPOOL PRO	M6	9258				*
XJ600	90' - 03'	SPOOL SLIDER	M6	4031				*
XJ700	90' - 03'	SPOOL	M6	5922				*
XJ700	90' - 03'	SPOOL PRO	M6	9258				*
XJ700	90' - 03'	SPOOL SLIDER	M6	4031				*
XJ900	83' - 94'	SPOOL	M6	5922				*
XJ900	83' - 94'	SPOOL PRO	M6	9258				*
XJ900	83' - 94'	SPOOL SLIDER	M6	4031				*
XJ6	09' - 16'	SPOOL	M6	5922				*
XJ6	09' - 16'	SPOOL PRO	M6	9258				*
XJ6	09' - 16'	SPOOL SLIDER	M6	4031				*
XJ6 DIVERSION	09' - 16'	SPOOL	M6	5922				*
XJ6 DIVERSION	09' - 16'	SPOOL PRO	M6	9258				*
XJ6 DIVERSION	09' - 16'	SPOOL SLIDER	M6	4031				*
XJ6 DIVERSION F	10' - 16'	SPOOL	M6	5922				*
XJ6 DIVERSION F	10' - 16'	SPOOL PRO	M6	9258				*
XJ6 DIVERSION F	10' - 16'	SPOOL SLIDER	M6	4031				*
XJ900S DIVERSION	94' - 03'	SPOOL	M6	5922				*
XJ900S DIVERSION	94' - 03'	SPOOL PRO	M6	9258				*
XJ900S DIVERSION	94' - 03'	SPOOL SLIDER	M6	4031				*
XT660X	04' - 16'	SPOOL	M6	5922				*
XT660X	04' - 16'	SPOOL PRO	M6	9258				*
XT660X	04' - 16'	SPOOL SLIDER	M6	4031				*
XT660R	04' - 16'	SPOOL	M6	5922				*
XT660R	04' - 16'	SPOOL PRO	M6	9258				*
XT660R	04' - 16'	SPOOL SLIDER	M6	4031				*
XT660Z TÉNÉRÉ	08' - 16'	SPOOL	M6	5922				*
XT660Z TÉNÉRÉ	08' - 16'	SPOOL PRO	M6	9258				*
XT660Z TÉNÉRÉ	08' - 16'	SPOOL SLIDER	M6	4031				*
XT1200Z SUPER TÉNÉRÉ	10' - 18'	SPOOL	M6	5922				*
XT1200Z SUPER TÉNÉRÉ	10' - 18'	SPOOL PRO	M6	9258				*
XT1200Z SUPER TÉNÉRÉ	10' - 18'	SPOOL SLIDER	M6	4031				*
YZF 600 R THUNDERCAT	96' - 02'	SPOOL	M6	5922				*
YZF 600 R THUNDERCAT	96' - 02'	SPOOL PRO	M6	9258				*
YZF 600 R THUNDERCAT	96' - 02'	SPOOL SLIDER	M6	4031				*
YZF-R125	08' - 18'	SPOOL	M6	5922				*



MODEL	YEAR	TYPE OF SPOOL	SCREW	REF.	
YZF-R125	08' - 18'	SPOOL PRO	M6	9258	(*)
YZF-R125	08' - 18'	SPOOL SLIDER	M6	4031	(*)
YZF-R6	99' - 18'	SPOOL	M6	5922	(*)
YZF-R6	99' - 18'	SPOOL PRO	M6	9258	(*)
YZF-R6	99' - 18'	SPOOL SLIDER	M6	4031	(*)
YZF 1000 R THUNDERACE	96' - 03'	SPOOL	M6	5922	(*)
YZF 1000 R THUNDERACE	96' - 03'	SPOOL PRO	M6	9258	(*)
YZF 1000 R THUNDERACE	96' - 03'	SPOOL SLIDER	M6	4031	(*)
YZF-R1	98' - 18'	SPOOL	M6	5922	(*)
YZF-R1	98' - 18'	SPOOL PRO	M6	9258	(*)
YZF-R1	98' - 18'	SPOOL SLIDER	M6	4031	(*)
YZF-R3	15' - 18'	SPOOL	M6	5922	(*)
YZF-R3	15' - 18'	SPOOL PRO	M6	9258	(*)
YZF-R3	15' - 18'	SPOOL SLIDER	M6	4031	(*)

// SPOOL PRO

// SPOOL SLIDER

// SPOOL

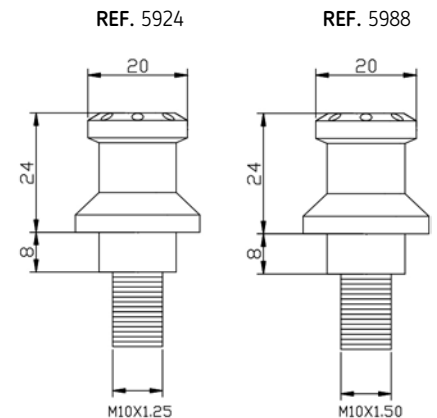
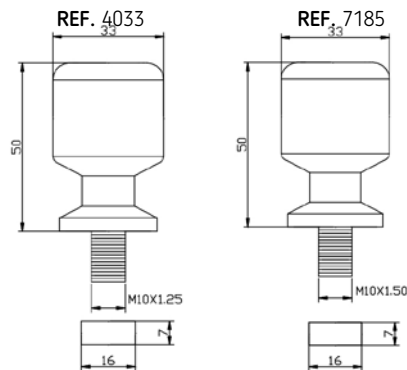
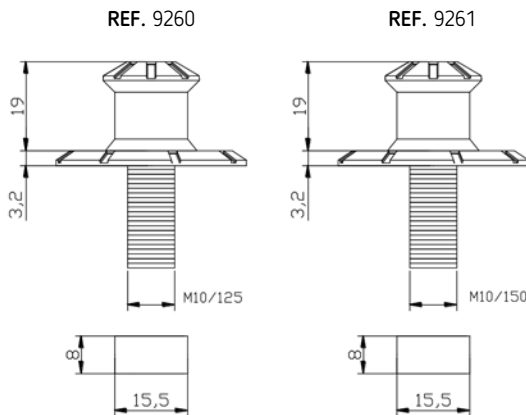
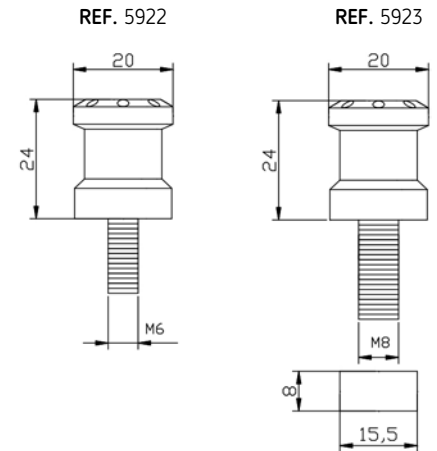
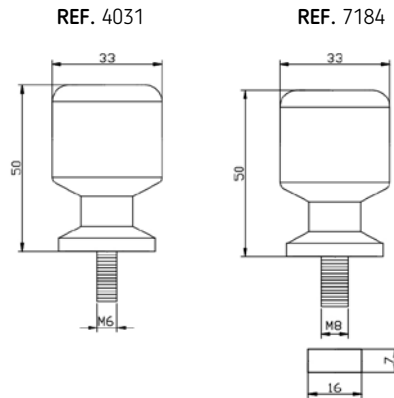
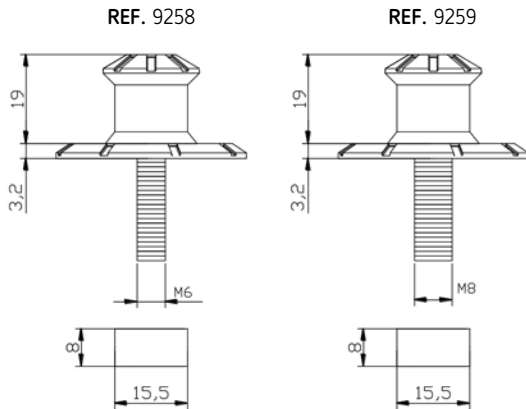

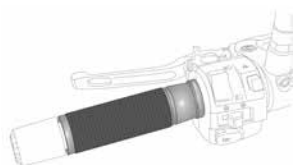

ASCENT / VINTAGE

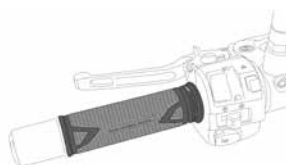

RADIKAL

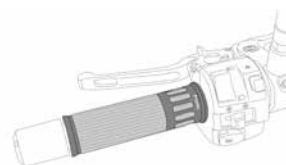

RACING

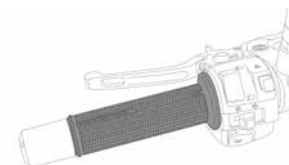

BASIC

MODEL	YEAR	TYPE OF GRIP	REF.	N	R O A T N P V C
APRILIA					
RS125	17' - 18'	ASCENT	6326	(*)	(*)
RS125	17' - 18'	RADIKAL	6325	(*)	(*)
RS125	17' - 18'	RACING	5879	(*)	(*)
RS125	17' - 18'	BASIC	6404-6405-6406	(*)	
TUONO 125	17' - 18'	ASCENT	6326	(*)	(*)
TUONO 125	17' - 18'	RADIKAL	6325	(*)	(*)
TUONO 125	17' - 18'	RACING	5879	(*)	(*)
TUONO 125	17' - 18'	BASIC	6404-6405-6406	(*)	
RSV4	09' - 12'	ASCENT	6326	(*)	(*)
RSV4	09' - 12'	RADIKAL	6325	(*)	(*)
RSV4	09' - 12'	RACING	5879	(*)	(*)
RSV4	09' - 12'	BASIC	6404-6405-6406	(*)	
RSV4 FACTORY	13' - 14'	ASCENT	6326	(*)	(*)
RSV4 FACTORY	13' - 14'	RADIKAL	6325	(*)	(*)
RSV4 FACTORY	13' - 14'	RACING	5879	(*)	(*)
RSV4 FACTORY	13' - 14'	BASIC	6404-6405-6406	(*)	
RSV4 RF	15' - 17'	ASCENT	6326	(*)	(*)
RSV4 RF	15' - 17'	RADIKAL	6325	(*)	(*)
RSV4 RF	15' - 17'	RACING	5879	(*)	(*)
RSV4 RF	15' - 17'	BASIC	6404-6405-6406	(*)	
RSV4 RR	15' - 17'	ASCENT	6326	(*)	(*)
RSV4 RR	15' - 17'	RADIKAL	6325	(*)	(*)
RSV4 RR	15' - 17'	RACING	5879	(*)	(*)
RSV4 RR	15' - 17'	BASIC	6404-6405-6406	(*)	
SHIVER 750	07' - 16'	ASCENT	6326	(*)	(*)
SHIVER 750	07' - 16'	RADIKAL	6325	(*)	(*)
SHIVER 750	07' - 16'	RACING	5879	(*)	(*)
SHIVER 750	07' - 16'	BASIC	6404-6405-6406	(*)	
SHIVER 900	17' - 18'	RADIKAL	6325	(*)	(*)
SHIVER 900	17' - 18'	RACING	5879	(*)	(*)
SHIVER 900	17' - 18'	BASIC	6404-6405-6406	(*)	
DORSODURO 900	17' - 18'	ASCENT	6326	(*)	(*)
DORSODURO 900	17' - 18'	RADIKAL	6325	(*)	(*)
DORSODURO 900	17' - 18'	RACING	5879	(*)	(*)
DORSODURO 900	17' - 18'	BASIC	6404-6405-6406	(*)	
TUONO V4R	11' - 14'	ASCENT	6326	(*)	(*)
TUONO V4R	11' - 14'	RADIKAL	6325	(*)	(*)
TUONO V4R	11' - 14'	RACING	5879	(*)	(*)

MODEL	YEAR	TYPE OF GRIP	REF.	N	
TUONO V4R	11' - 14'	BASIC	6404-6405-6406	(*)	
TUONO V4RR	15' - 17'	ASCENT	6326	(*)	(*)
TUONO V4RR	15' - 17'	RADIKAL	6325	(*)	(*)
TUONO V4RR	15' - 17'	RACING	5879	(*)	(*)
TUONO V4RR	15' - 17'	BASIC	6404-6405-6406	(*)	
TUONO V4 FACTORY	15' - 17'	ASCENT	6326	(*)	(*)
TUONO V4 FACTORY	15' - 17'	RADIKAL	6325	(*)	(*)
TUONO V4 FACTORY	15' - 17'	RACING	5879	(*)	(*)
TUONO V4 FACTORY	15' - 17'	BASIC	6404-6405-6406	(*)	
BMW					
G310 GS	17' - 18'	RADIKAL	6325	(*)	(*)
G310 GS	17' - 18'	RACING	5879	(*)	(*)
G310 GS	17' - 18'	BASIC	6404-6405-6406	(*)	
G310 R	16' - 18'	RADIKAL	6325	(*)	(*)
G310 R	16' - 18'	RACING	5879	(*)	(*)
G310 R	16' - 18'	BASIC	6404-6405-6406	(*)	
C600 SPORT	12' - 15'	RADIKAL	6325	(*)	(*)
C600 SPORT	12' - 15'	RACING	5879	(*)	(*)
C600 SPORT	12' - 15'	BASIC	6404-6405-6406	(*)	
C650 SPORT	16' - 18'	ASCENT	6326	(*)	(*)
C650 SPORT	16' - 18'	RADIKAL	6325	(*)	(*)
C650 SPORT	16' - 18'	RACING	5879	(*)	(*)
C650 SPORT	16' - 18'	BASIC	6404-6405-6406	(*)	
C650 GT	12' - 18'	RADIKAL	6325	(*)	(*)
C650 GT	12' - 18'	RACING	5879	(*)	(*)
C650 GT	12' - 18'	BASIC	6404-6405-6406	(*)	
F650 GS	08' - 12'	RADIKAL	6325	(*)	(*)
F650 GS	08' - 12'	RACING	5879	(*)	(*)
F650 GS	08' - 12'	BASIC	6404-6405-6406	(*)	
F700 GS	12' - 17'	RADIKAL	6325	(*)	(*)
F700 GS	12' - 17'	RACING	5879	(*)	(*)
F700 GS	12' - 17'	BASIC	6404-6405-6406	(*)	
F800 GT	13' - 17'	RADIKAL	6325	(*)	(*)
F800 GT	13' - 17'	RACING	5879	(*)	(*)
F800 GT	13' - 17'	BASIC	6404-6405-6406	(*)	
F800 GS	08' - 17'	RADIKAL	6325	(*)	(*)
F800 GS	08' - 17'	RACING	5879	(*)	(*)
F800 GS	08' - 17'	BASIC	6404-6405-6406	(*)	
F800R	09' - 18'	ASCENT	6326	(*)	(*)
F800R	09' - 18'	RADIKAL	6325	(*)	(*)
F800R	09' - 18'	RACING	5879	(*)	(*)
F800R	09' - 18'	BASIC	6404-6405-6406	(*)	

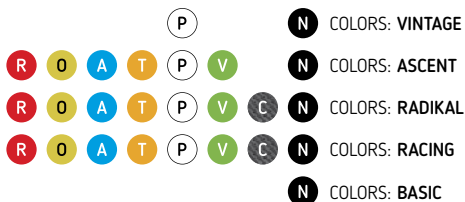

(*) Check price with your distributor.

IMPORTANT: Indicate code color after part#. Example: 0973A.

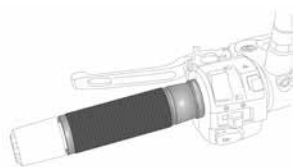

ASCENT / VINTAGE

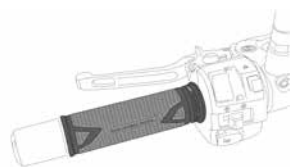

RADIKAL

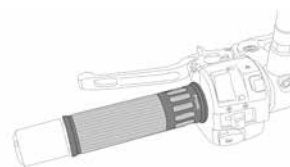

RACING

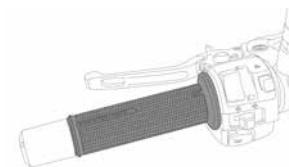

BASIC

MODEL	YEAR	TYPE OF GRIP	REF.	N	R O A T N P V C
G650 GS	11' - 16'	RADIKAL	6325	(*)	(*)
G650 GS	11' - 16'	RACING	5879	(*)	(*)
G650 GS	11' - 16'	BASIC	6404-6405-6406	(*)	
R1200 R	06' - 18'	RADIKAL	6325	(*)	(*)
R1200 R	06' - 18'	RACING	5879	(*)	(*)
R1200 R	06' - 18'	BASIC	6404-6405-6406	(*)	
R1200 RS	15' - 18'	RADIKAL	6325	(*)	(*)
R1200 RS	15' - 18'	RACING	5879	(*)	(*)
R1200 RS	15' - 18'	BASIC	6404-6405-6406	(*)	
R1200 GS	04' - 18'	RADIKAL	6325	(*)	(*)
R1200 GS	04' - 18'	RACING	5879	(*)	(*)
R1200 GS	04' - 18'	BASIC	6404-6405-6406	(*)	
R1200GS EXCLUSIVE	17' - 18'	RADIKAL	6325	(*)	(*)
R1200GS EXCLUSIVE	17' - 18'	RACING	5879	(*)	(*)
R1200GS EXCLUSIVE	17' - 18'	BASIC	6404-6405-6406	(*)	
R1200GS RALLYE	17' - 18'	RADIKAL	6325	(*)	(*)
R1200GS RALLYE	17' - 18'	RACING	5879	(*)	(*)
R1200GS RALLYE	17' - 18'	BASIC	6404-6405-6406	(*)	
R1200 GS ADVENTURE	07' - 13'	RADIKAL	6325	(*)	(*)
R1200 GS ADVENTURE	07' - 13'	RACING	5879	(*)	(*)
R1200 GS ADVENTURE	07' - 13'	BASIC	6404-6405-6406	(*)	
R NINE T	14' - 18'	RADIKAL	6325	(*)	(*)
R NINE T	14' - 18'	RACING	5879	(*)	(*)
R NINE T	14' - 18'	BASIC	6404-6405-6406	(*)	
R NINE T SCRAMBLER	16' - 18'	RADIKAL	6325	(*)	(*)
R NINE T SCRAMBLER	16' - 18'	RACING	5879	(*)	(*)
R NINE T SCRAMBLER	16' - 18'	BASIC	6404-6405-6406	(*)	
R NINE T PURE	17' - 18'	RADIKAL	6325	(*)	(*)
R NINE T PURE	17' - 18'	RACING	5879	(*)	(*)
R NINE T PURE	17' - 18'	BASIC	6404-6405-6406	(*)	
R NINE T RACER	17' - 18'	RADIKAL	6325	(*)	(*)
R NINE T RACER	17' - 18'	RACING	5879	(*)	(*)
R NINE T RACER	17' - 18'	BASIC	6404-6405-6406	(*)	
R NINE T URBAN G/S	17' - 18'	RADIKAL	6325	(*)	(*)
R NINE T URBAN G/S	17' - 18'	RACING	5879	(*)	(*)
R NINE T URBAN G/S	17' - 18'	BASIC	6404-6405-6406	(*)	
S1000 R	14' - 18'	RADIKAL	6325	(*)	(*)
S1000 R	14' - 18'	RACING	5879	(*)	(*)
S1000 R	14' - 18'	BASIC	6404-6405-6406	(*)	

MODEL	YEAR	TYPE OF GRIP	REF.	N	
S1000 RR	09' - 18'	RADIKAL	6325	(*)	(*)
S1000 RR	09' - 18'	RACING	5879	(*)	(*)
S1000 RR	09' - 18'	BASIC	6404-6405-6406	(*)	(*)
S1000 XR	15' - 18'	RADIKAL	6325	(*)	(*)
S1000 XR	15' - 18'	RACING	5879	(*)	(*)
S1000 XR	15' - 18'	BASIC	6404-6405-6406	(*)	(*)
DUCATI					
749S	03' - 06'	ASCENT	6326	(*)	(*)
749S	03' - 06'	RADIKAL	6325	(*)	(*)
749S	03' - 06'	RACING	5879	(*)	(*)
749S	03' - 06'	BASIC	6404-6405-6406	(*)	(*)
749R	03' - 06'	ASCENT	6326	(*)	(*)
749R	03' - 06'	RADIKAL	6325	(*)	(*)
749R	03' - 06'	RACING	5879	(*)	(*)
749R	03' - 06'	BASIC	6404-6405-6406	(*)	(*)
848	08' - 10'	ASCENT	6326	(*)	(*)
848	08' - 10'	RADIKAL	6325	(*)	(*)
848	08' - 10'	RACING	5879	(*)	(*)
848	08' - 10'	BASIC	6404-6405-6406	(*)	(*)
899 PANIGALE	14' - 15'	ASCENT	6326	(*)	(*)
899 PANIGALE	14' - 15'	RADIKAL	6325	(*)	(*)
899 PANIGALE	14' - 15'	RACING	5879	(*)	(*)
899 PANIGALE	14' - 15'	BASIC	6404-6405-6406	(*)	(*)
999S	05' - 06'	ASCENT	6326	(*)	(*)
999S	05' - 06'	RADIKAL	6325	(*)	(*)
999S	05' - 06'	RACING	5879	(*)	(*)
999S	05' - 06'	BASIC	6404-6405-6406	(*)	(*)
999R	05' - 06'	ASCENT	6326	(*)	(*)
999R	05' - 06'	RADIKAL	6325	(*)	(*)
999R	05' - 06'	RACING	5879	(*)	(*)
999R	05' - 06'	BASIC	6404-6405-6406	(*)	(*)
1098	07' - 08'	ASCENT	6326	(*)	(*)
1098	07' - 08'	RADIKAL	6325	(*)	(*)
1098	07' - 08'	RACING	5879	(*)	(*)
1098	07' - 08'	BASIC	6404-6405-6406	(*)	(*)
1198	09' - 11'	ASCENT	6326	(*)	(*)
1198	09' - 11'	RADIKAL	6325	(*)	(*)
1198	09' - 11'	RACING	5879	(*)	(*)
1198	09' - 11'	BASIC	6404-6405-6406	(*)	(*)
1198S	09' - 11'	ASCENT	6326	(*)	(*)
1198S	09' - 11'	RADIKAL	6325	(*)	(*)
1198S	09' - 11'	RACING	5879	(*)	(*)

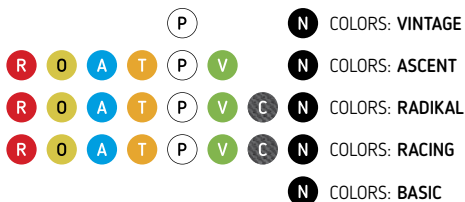

(*) Check price with your distributor.

IMPORTANT: Indicate code color after part#. Example: 0973A.

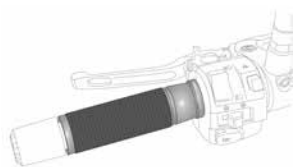

ASCENT / VINTAGE

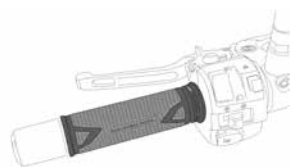

RADIKAL

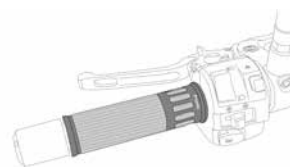

RACING

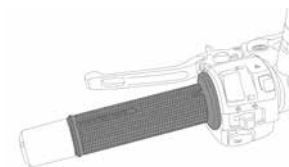

BASIC

MODEL	YEAR	TYPE OF GRIP	REF.	N	R O A T N P V C
1198S	09' - 11'	BASIC	6404-6405-6406	(*)	
1199 PANIGALE	12' - 14'	ASCENT	6326	(*)	(*)
1199 PANIGALE	12' - 14'	RADIKAL	6325	(*)	(*)
1199 PANIGALE	12' - 14'	RACING	5879	(*)	(*)
1199 PANIGALE	12' - 14'	BASIC	6404-6405-6406	(*)	
1199 SUPERLEGGERA	14'	ASCENT	6326	(*)	(*)
1199 SUPERLEGGERA	14'	RADIKAL	6325	(*)	(*)
1199 SUPERLEGGERA	14'	RACING	5879	(*)	(*)
1199 SUPERLEGGERA	14'	BASIC	6404-6405-6406	(*)	
1299 PANIGALE/S	15' - 17'	ASCENT	6326	(*)	(*)
1299 PANIGALE/S	15' - 17'	RADIKAL	6325	(*)	(*)
1299 PANIGALE/S	15' - 17'	RACING	5879	(*)	(*)
1299 PANIGALE/S	15' - 17'	BASIC	6404-6405-6406	(*)	
DIAVEL	11' - 18'	ASCENT	6326	(*)	(*)
DIAVEL	11' - 18'	RADIKAL	6325	(*)	(*)
DIAVEL	11' - 18'	RACING	5879	(*)	(*)
DIAVEL	11' - 18'	BASIC	6404-6405-6406	(*)	
X DIAVEL/S	16' - 18'	RADIKAL	6325	(*)	(*)
X DIAVEL/S	16' - 18'	RACING	5879	(*)	(*)
X DIAVEL/S	16' - 18'	BASIC	6404-6405-6406	(*)	
HYPERMOTARD 821/SP	13' - 15'	ASCENT	6326	(*)	(*)
HYPERMOTARD 821/SP	13' - 15'	RADIKAL	6325	(*)	(*)
HYPERMOTARD 821/SP	13' - 15'	RACING	5879	(*)	(*)
HYPERMOTARD 821/SP	13' - 15'	BASIC	6404-6405-6406	(*)	
HYPERMOTARD 939/SP	16' - 18'	ASCENT	6326	(*)	(*)
HYPERMOTARD 939/SP	16' - 18'	RADIKAL	6325	(*)	(*)
HYPERMOTARD 939/SP	16' - 18'	RACING	5879	(*)	(*)
HYPERMOTARD 939/SP	16' - 18'	BASIC	6404-6405-6406	(*)	
HYPERSTRADA	13' - 15'	ASCENT	6326	(*)	(*)
HYPERSTRADA	13' - 15'	RADIKAL	6325	(*)	(*)
HYPERSTRADA	13' - 15'	RACING	5879	(*)	(*)
HYPERSTRADA	13' - 15'	BASIC	6404-6405-6406	(*)	
HYPERSTRADA 939	16' - 17'	ASCENT	6326	(*)	(*)
HYPERSTRADA 939	16' - 17'	RADIKAL	6325	(*)	(*)
HYPERSTRADA 939	16' - 17'	RACING	5879	(*)	(*)
HYPERSTRADA 939	16' - 17'	BASIC	6404-6405-6406	(*)	
MONSTER 696	08' - 14'	ASCENT	6326	(*)	(*)
MONSTER 696	08' - 14'	RADIKAL	6325	(*)	(*)
MONSTER 696	08' - 14'	RACING	5879	(*)	(*)

MODEL	YEAR	TYPE OF GRIP	REF.	N	
MONSTER 696	08' - 14'	BASIC	6404-6405-6406	(*)	
MONSTER 796	10' - 14'	ASCENT	6326	(*)	(*)
MONSTER 796	10' - 14'	RADIKAL	6325	(*)	(*)
MONSTER 796	10' - 14'	RACING	5879	(*)	(*)
MONSTER 796	10' - 14'	BASIC	6404-6405-6406	(*)	
MONSTER 797	17' -18'	RADIKAL	6325	(*)	(*)
MONSTER 797	17' -18'	RACING	5879	(*)	(*)
MONSTER 797	17' -18'	BASIC	6404-6405-6406	(*)	
MONSTER 821/STRIPE	14' - 18'	RADIKAL	6325	(*)	(*)
MONSTER 821/STRIPE	14' - 18'	RACING	5879	(*)	(*)
MONSTER 821/STRIPE	14' - 18'	BASIC	6404-6405-6406	(*)	
MONSTER 1100	09' - 10'	ASCENT	6326	(*)	(*)
MONSTER 1100	09' - 10'	RADIKAL	6325	(*)	(*)
MONSTER 1100	09' - 10'	RACING	5879	(*)	(*)
MONSTER 1100	09' - 10'	BASIC	6404-6405-6406	(*)	
MONSTER 1100 EVO	11' - 13'	ASCENT	6326	(*)	(*)
MONSTER 1100 EVO	11' - 13'	RADIKAL	6325	(*)	(*)
MONSTER 1100 EVO	11' - 13'	RACING	5879	(*)	(*)
MONSTER 1100 EVO	11' - 13'	BASIC	6404-6405-6406	(*)	
MONSTER 1200/S	14' - 18'	RADIKAL	6325	(*)	(*)
MONSTER 1200/S	14' - 18'	RACING	5879	(*)	(*)
MONSTER 1200/S	14' - 18'	BASIC	6404-6405-6406	(*)	
MONSTER 1200 R	16' - 18'	RADIKAL	6325	(*)	(*)
MONSTER 1200 R	16' - 18'	RACING	5879	(*)	(*)
MONSTER 1200 R	16' - 18'	BASIC	6404-6405-6406	(*)	
MULTISTRADA 950	17' -18'	RADIKAL	6325	(*)	(*)
MULTISTRADA 950	17' -18'	RACING	5879	(*)	(*)
MULTISTRADA 950	17' -18'	BASIC	6404-6405-6406	(*)	
MULTISTRADA 1200/S	10' - 17'	ASCENT	6326	(*)	(*)
MULTISTRADA 1200/S	10' - 17'	RADIKAL	6325	(*)	(*)
MULTISTRADA 1200/S	10' - 17'	RACING	5879	(*)	(*)
MULTISTRADA 1200/S	10' - 17'	BASIC	6404-6405-6406	(*)	
MULTISTRADA 1200 PIKES PEAK	16' - 17'	ASCENT	6326	(*)	(*)
MULTISTRADA 1200 PIKES PEAK	16' - 17'	RADIKAL	6325	(*)	(*)
MULTISTRADA 1200 PIKES PEAK	16' - 17'	RACING	5879	(*)	(*)
MULTISTRADA 1200 PIKES PEAK	16' - 17'	BASIC	6404-6405-6406	(*)	
MULTISTRADA 1200 ENDURO	16' - 17'	ASCENT	6326	(*)	(*)
MULTISTRADA 1200 ENDURO	16' - 17'	RADIKAL	6325	(*)	(*)
MULTISTRADA 1200 ENDURO	16' - 17'	RACING	5879	(*)	(*)
MULTISTRADA 1200 ENDURO	16' - 17'	BASIC	6404-6405-6406	(*)	
SCRAMBLER ICON/CLASSIC/FULL THROTTLE	15' - 18'	ASCENT	6326	(*)	(*)
SCRAMBLER ICON/CLASSIC/FULL THROTTLE	15' - 18'	VINTAGE	9190	(*)	(*)

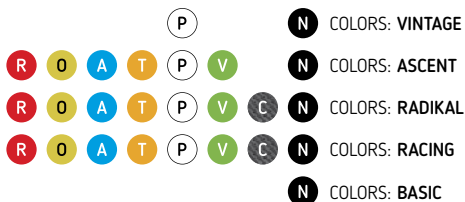

(*) Check price with your distributor.

IMPORTANT: Indicate code color after part#. Example: 0973A.

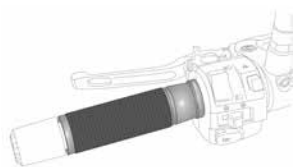

ASCENT / VINTAGE

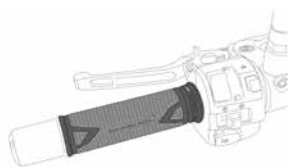

RADIKAL

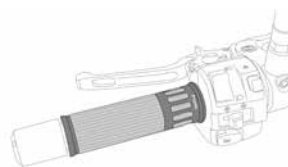

RACING

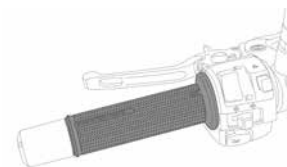

BASIC

MODEL	YEAR	TYPE OF GRIP	REF.	N	R O A T N P V C
SCRAMBLER ICON/CLASSIC/FULL THROTTLE	15' - 18'	RADIKAL	6325	(*)	(*)
SCRAMBLER ICON/CLASSIC/FULL THROTTLE	15' - 18'	RACING	5879	(*)	(*)
SCRAMBLER ICON/CLASSIC/FULL THROTTLE	15' - 18'	BASIC	6404-6405-6406	(*)	
SCRAMBLER SIXTY2	16' - 18'	ASCENT	6326	(*)	(*)
SCRAMBLER SIXTY2	16' - 18'	VINTAGE	9190	(*)	(*)
SCRAMBLER SIXTY2	16' - 18'	RADIKAL	6325	(*)	(*)
SCRAMBLER SIXTY2	16' - 18'	RACING	5879	(*)	(*)
SCRAMBLER SIXTY2	16' - 18'	BASIC	6404-6405-6406	(*)	
SCRAMBLER URBAN ENDURO	15'- 16'	ASCENT	6326	(*)	(*)
SCRAMBLER URBAN ENDURO	15'- 16'	VINTAGE	9190	(*)	(*)
SCRAMBLER URBAN ENDURO	15'- 16'	RADIKAL	6325	(*)	(*)
SCRAMBLER URBAN ENDURO	15'- 16'	RACING	5879	(*)	(*)
SCRAMBLER URBAN ENDURO	15'- 16'	BASIC	6404-6405-6406	(*)	
SCRAMBLER FLAT TRACK PRO	16'	ASCENT	6326	(*)	(*)
SCRAMBLER FLAT TRACK PRO	16'	VINTAGE	9190	(*)	(*)
SCRAMBLER FLAT TRACK PRO	16'	RADIKAL	6325	(*)	(*)
SCRAMBLER FLAT TRACK PRO	16'	RACING	5879	(*)	(*)
SCRAMBLER FLAT TRACK PRO	16'	BASIC	6404-6405-6406	(*)	
SCRAMBLER DESERT SLED	17' -18'	RADIKAL	6325	(*)	(*)
SCRAMBLER DESERT SLED	17' -18'	RACING	5879	(*)	(*)
SCRAMBLER DESERT SLED	17' -18'	BASIC	6404-6405-6406	(*)	
SCRAMBLER CAFE RACER	17' -18'	RADIKAL	6325	(*)	(*)
SCRAMBLER CAFE RACER	17' -18'	RACING	5879	(*)	(*)
SCRAMBLER CAFE RACER	17' -18'	BASIC	6404-6405-6406	(*)	
STREETFIGHTER 848	12' - 16'	ASCENT	6326	(*)	(*)
STREETFIGHTER 848	12' - 16'	RADIKAL	6325	(*)	(*)
STREETFIGHTER 848	12' - 16'	RACING	5879	(*)	(*)
STREETFIGHTER 848	12' - 16'	BASIC	6404-6405-6406	(*)	
STREETFIGHTER 1100	09' - 12'	ASCENT	6326	(*)	(*)
STREETFIGHTER 1100	09' - 12'	RADIKAL	6325	(*)	(*)
STREETFIGHTER 1100	09' - 12'	RACING	5879	(*)	(*)
STREETFIGHTER 1100	09' - 12'	BASIC	6404-6405-6406	(*)	
STREETFIGHTER 1100 S	09' - 13'	ASCENT	6326	(*)	(*)
STREETFIGHTER 1100 S	09' - 13'	RADIKAL	6325	(*)	(*)
STREETFIGHTER 1100 S	09' - 13'	RACING	5879	(*)	(*)
STREETFIGHTER 1100 S	09' - 13'	BASIC	6404-6405-6406	(*)	
SUPERSPORT 939/S	17' -18'	RADIKAL	6325	(*)	(*)
SUPERSPORT 939/S	17' -18'	RACING	5879	(*)	(*)
SUPERSPORT 939/S	17' -18'	BASIC	6404-6405-6406	(*)	

MODEL	YEAR	TYPE OF GRIP	REF.	N	
HONDA					
CB125R NEO SPORTS CAFE	18'	ASCENT	6326	(*)	(*)
CB125R NEO SPORTS CAFE	18'	VINTAGE	9190	(*)	(*)
CB300R NEO SPORTS CAFE	18'	VINTAGE	9190	(*)	(*)
CB300R NEO SPORTS CAFE	18'	VINTAGE	6326	(*)	(*)
CB300R NEO SPORTS CAFE	18'	RADIKAL	6325	(*)	(*)
CB300R NEO SPORTS CAFE	18'	RACING	5879	(*)	(*)
CB300R NEO SPORTS CAFE	18'	BASIC	6404-6405-6406	(*)	(*)
CB500F	13' - 18'	ASCENT	6326	(*)	(*)
CB500F	13' - 18'	RADIKAL	6325	(*)	(*)
CB500F	13' - 18'	RACING	5879	(*)	(*)
CB500F	13' - 18'	BASIC	6404-6405-6406	(*)	(*)
CB500X	13' - 18'	ASCENT	6326	(*)	(*)
CB500X	13' - 18'	RADIKAL	6325	(*)	(*)
CB500X	13' - 18'	RACING	5879	(*)	(*)
CB500X	13' - 17'	BASIC	6404-6405-6406	(*)	(*)
CB600F HORNET	98' - 16'	ASCENT	6326	(*)	(*)
CB600F HORNET	98' - 16'	RADIKAL	6325	(*)	(*)
CB600F HORNET	98' - 16'	RACING	5879	(*)	(*)
CB600F HORNET	98' - 16'	BASIC	6404-6405-6406	(*)	(*)
CB650F	14' - 18'	ASCENT	6326	(*)	(*)
CB650F	14' - 18'	RADIKAL	6325	(*)	(*)
CB650F	14' - 18'	RACING	5879	(*)	(*)
CB650F	14' - 18'	BASIC	6404-6405-6406	(*)	(*)
CB900F HORNET	02' - 05'	ASCENT	6326	(*)	(*)
CB900F HORNET	02' - 05'	RADIKAL	6325	(*)	(*)
CB900F HORNET	02' - 05'	RACING	5879	(*)	(*)
CB900F HORNET	02' - 05'	BASIC	6404-6405-6406	(*)	(*)
CB1000R	08' - 16'	ASCENT	6326	(*)	(*)
CB1000R	08' - 16'	RADIKAL	6325	(*)	(*)
CB1000R	08' - 16'	RACING	5879	(*)	(*)
CB1000R	08' - 16'	BASIC	6404-6405-6406	(*)	(*)
CB1100	13' - 14'	ASCENT	6326	(*)	(*)
CB1100	13' - 14'	VINTAGE	9190	(*)	(*)
CB1100	13' - 14'	RADIKAL	6325	(*)	(*)
CB1100	13' - 14'	RACING	5879	(*)	(*)
CB1100	13' - 14'	BASIC	6404-6405-6406	(*)	(*)
CB1100RS	17' - 18'	ASCENT	6326	(*)	(*)
CB1100RS	17' - 18'	VINTAGE	9190	(*)	(*)
CB1100RS	17' - 18'	RADIKAL	6325	(*)	(*)
CB1100RS	17' - 18'	RACING	5879	(*)	(*)
CB1100RS	17' - 18'	BASIC	6404-6405-6406	(*)	(*)

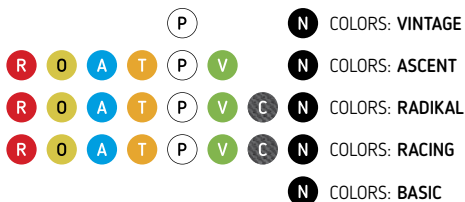

(*) Check price with your distributor.

IMPORTANT: Indicate code color after part#. Example: 0973A.

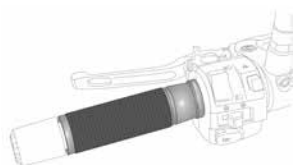

ASCENT / VINTAGE

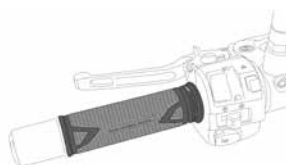

RADIKAL

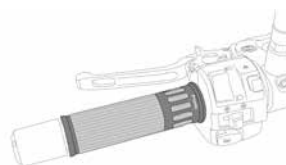

RACING

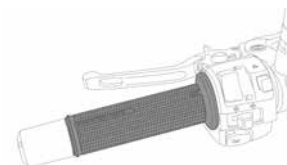

BASIC

MODEL	YEAR	TYPE OF GRIP	REF.	N	R O A T N P V C
CB1100EX	17' -18'	ASCENT	6326	(*)	(*)
CB1100EX	17' -18'	VINTAGE	9190	(*)	(*)
CB1100EX	17' -18'	RADIKAL	6325	(*)	(*)
CB1100EX	17' -18'	RACING	5879	(*)	(*)
CB1100EX	17' -18'	BASIC	6404-6405-6406	(*)	(*)
CB1300	03' - 10'	ASCENT	6326	(*)	(*)
CB1300	03' - 10'	RADIKAL	6325	(*)	(*)
CB1300	03' - 10'	RACING	5879	(*)	(*)
CB1300	03' - 10'	BASIC	6404-6405-6406	(*)	(*)
CBF600/S	04' - 14'	ASCENT	6326	(*)	(*)
CBF600/S	04' - 14'	RADIKAL	6325	(*)	(*)
CBF600/S	04' - 14'	RACING	5879	(*)	(*)
CBF600/S	04' - 14'	BASIC	6404-6405-6406	(*)	(*)
CBR250R	11' - 14'	ASCENT	6326	(*)	(*)
CBR250R	11' - 14'	RADIKAL	6325	(*)	(*)
CBR250R	11' - 14'	RACING	5879	(*)	(*)
CBR250R	11' - 14'	BASIC	6404-6405-6406	(*)	(*)
CBR500R	13' - 18'	ASCENT	6326	(*)	(*)
CBR500R	13' - 18'	RADIKAL	6325	(*)	(*)
CBR500R	13' - 18'	RACING	5879	(*)	(*)
CBR500R	13' - 18'	BASIC	6404-6405-6406	(*)	(*)
CBR600F	86' - 07'	ASCENT	6326	(*)	(*)
CBR600F	86' - 07'	RADIKAL	6325	(*)	(*)
CBR600F	86' - 07'	RACING	5879	(*)	(*)
CBR600F	86' - 07'	BASIC	6404-6405-6406	(*)	(*)
CBR600F	11' - 13'	ASCENT	6326	(*)	(*)
CBR600F	11' - 13'	RADIKAL	6325	(*)	(*)
CBR600F	11' - 13'	RACING	5879	(*)	(*)
CBR600F	11' - 13'	BASIC	6404-6405-6406	(*)	(*)
CBR650F	14' - 18'	ASCENT	6326	(*)	(*)
CBR650F	14' - 18'	RADIKAL	6325	(*)	(*)
CBR650F	14' - 18'	RACING	5879	(*)	(*)
CBR650F	14' - 18'	BASIC	6404-6405-6406	(*)	(*)
CBR600RR	03' - 16'	ASCENT	6326	(*)	(*)
CBR600RR	03' - 16'	RADIKAL	6325	(*)	(*)
CBR600RR	03' - 16'	RACING	5879	(*)	(*)
CBR600RR	03' - 16'	BASIC	6404-6405-6406	(*)	(*)
CBR900RR FIRE BLADE	96' - 03'	ASCENT	6326	(*)	(*)
CBR900RR FIRE BLADE	96' - 03'	RADIKAL	6325	(*)	(*)

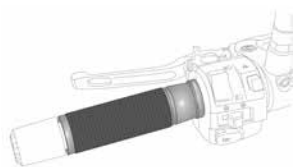

ASCENT / VINTAGE

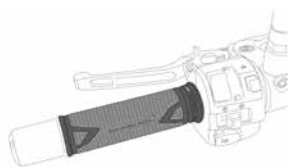

RADIKAL

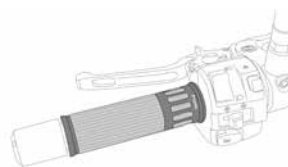

RACING

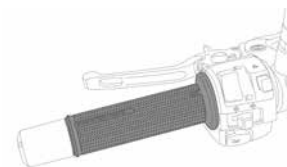

BASIC

MODEL	YEAR	TYPE OF GRIP	REF.	N	R O A T N P V C
NT700V DEAUVILLE	06' - 17'	RADIKAL	6325	(*)	(*)
NT700V DEAUVILLE	06' - 17'	RACING	5879	(*)	(*)
NT700V DEAUVILLE	06' - 17'	BASIC	6404-6405-6406	(*)	
MSX125	14' - 18'	ASCENT	6326	(*)	(*)
MSX125	14' - 18'	RADIKAL	6325	(*)	(*)
MSX125	14' - 18'	RACING	5879	(*)	(*)
MSX125	14' - 18'	BASIC	6404-6405-6406	(*)	
VFR800	02' - 05'	ASCENT	6326	(*)	(*)
VFR800	02' - 05'	RADIKAL	6325	(*)	(*)
VFR800	02' - 05'	RACING	5879	(*)	(*)
VFR800	02' - 05'	BASIC	6404-6405-6406	(*)	
VFR800F	14' - 18'	ASCENT	6326	(*)	(*)
VFR800F	14' - 18'	RADIKAL	6325	(*)	(*)
VFR800F	14' - 18'	RACING	5879	(*)	(*)
VFR800F	14' - 18'	BASIC	6404-6405-6406	(*)	
VTR1000 SP-1	00' - 02'	ASCENT	6326	(*)	(*)
VTR1000 SP-1	00' - 02'	RADIKAL	6325	(*)	(*)
VTR1000 SP-1	00' - 02'	RACING	5879	(*)	(*)
VTR1000 SP-1	00' - 02'	BASIC	6404-6405-6406	(*)	
VTR1000 SP-2	02' - 05'	ASCENT	6326	(*)	(*)
VTR1000 SP-2	02' - 05'	RADIKAL	6325	(*)	(*)
VTR1000 SP-2	02' - 05'	RACING	5879	(*)	(*)
VTR1000 SP-2	02' - 05'	BASIC	6404-6405-6406	(*)	
VFR1200F	10' - 16'	ASCENT	6326	(*)	(*)
VFR1200F	10' - 16'	RADIKAL	6325	(*)	(*)
VFR1200F	10' - 16'	RACING	5879	(*)	(*)
VFR1200F	10' - 16'	BASIC	6404-6405-6406	(*)	
X-ADV	17' - 18'	ASCENT	6326	(*)	(*)
X-ADV	17' - 18'	RADIKAL	6325	(*)	(*)
X-ADV	17' - 18'	RACING	5879	(*)	(*)
X-ADV	17' - 18'	BASIC	6404-6405-6406	(*)	
KAWASAKI					
J125	16' - 18'	ASCENT	6326	(*)	(*)
J125	16' - 18'	RADIKAL	6325	(*)	(*)
J125	16' - 18'	RACING	5879	(*)	(*)
J125	16' - 18'	BASIC	6404-6405-6406	(*)	
J300	14'-18'	ASCENT	6326	(*)	(*)
J300	14'-18'	RADIKAL	6325	(*)	(*)
J300	14'-18'	RACING	5879	(*)	(*)

MODEL	YEAR	TYPE OF GRIP	REF.	N	
J300	14' - 18'	BASIC	6404-6405-6406	(*)	
ER-5	04' - 05'	ASCENT	6326	(*)	(*)
ER-5	04' - 05'	RADIKAL	6325	(*)	(*)
ER-5	04' - 05'	RACING	5879	(*)	(*)
ER-5	04' - 05'	BASIC	6404-6405-6406	(*)	
ER-6F	06' - 16'	ASCENT	6326	(*)	(*)
ER-6F	06' - 16'	RADIKAL	6325	(*)	(*)
ER-6F	06' - 16'	RACING	5879	(*)	(*)
ER-6F	06' - 16'	BASIC	6404-6405-6406	(*)	
ER-6N	06' - 16'	ASCENT	6326	(*)	(*)
ER-6N	06' - 16'	RADIKAL	6325	(*)	(*)
ER-6N	06' - 16'	RACING	5879	(*)	(*)
ER-6N	06' - 16'	BASIC	6404-6405-6406	(*)	
GPZ500S	90' - 95'	ASCENT	6326	(*)	(*)
GPZ500S	90' - 95'	RADIKAL	6325	(*)	(*)
GPZ500S	90' - 95'	RACING	5879	(*)	(*)
GPZ500S	90' - 95'	BASIC	6404-6405-6406	(*)	
KLE500	91' - 97'	ASCENT	6326	(*)	(*)
KLE500	91' - 97'	RADIKAL	6325	(*)	(*)
KLE500	91' - 97'	RACING	5879	(*)	(*)
KLE500	91' - 97'	BASIC	6404-6405-6406	(*)	
NINJA H2/H2R	15' - 18'	ASCENT	6326	(*)	(*)
NINJA H2/H2R	15' - 18'	RADIKAL	6325	(*)	(*)
NINJA H2/H2R	15' - 18'	RACING	5879	(*)	(*)
NINJA H2/H2R	15' - 18'	BASIC	6404-6405-6406	(*)	
NINJA 250R	08' - 12'	ASCENT	6326	(*)	(*)
NINJA 250R	08' - 12'	RADIKAL	6325	(*)	(*)
NINJA 250R	08' - 12'	RACING	5879	(*)	(*)
NINJA 250R	08' - 12'	BASIC	6404-6405-6406	(*)	
NINJA 250SL	15' - 16'	ASCENT	6326	(*)	(*)
NINJA 250SL	15' - 16'	RADIKAL	6325	(*)	(*)
NINJA 250SL	15' - 16'	RACING	5879	(*)	(*)
NINJA 250SL	15' - 16'	BASIC	6404-6405-6406	(*)	
NINJA 300	13' - 17'	ASCENT	6326	(*)	(*)
NINJA 300	13' - 17'	RADIKAL	6325	(*)	(*)
NINJA 300	13' - 17'	RACING	5879	(*)	(*)
NINJA 300	13' - 17'	BASIC	6404-6405-6406	(*)	
NINJA 400	18'	ASCENT	6326	(*)	(*)
NINJA 400	18'	RADIKAL	6325	(*)	(*)
NINJA 400	18'	RACING	5879	(*)	(*)
NINJA 400	18'	BASIC	6404-6405-6406	(*)	
NINJA 650	17' - 18'	ASCENT	6326	(*)	(*)

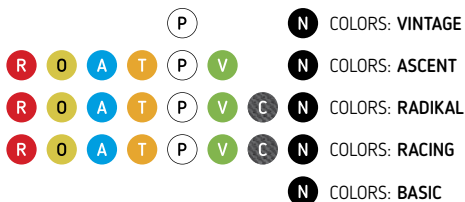

(*) Check price with your distributor.

IMPORTANT: Indicate code color after part#. Example: 0973A.

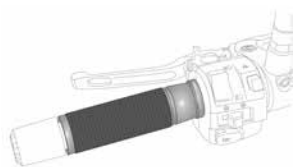

ASCENT / VINTAGE

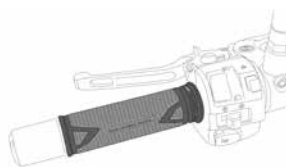

RADIKAL

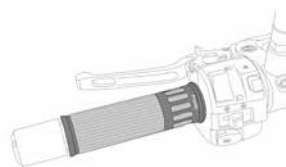

RACING

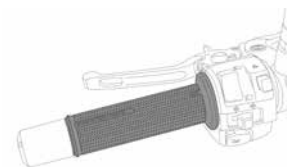

BASIC

MODEL	YEAR	TYPE OF GRIP	REF.	N	R O A T N P V C
NINJA 650	17' -18'	RADIKAL	6325	(*)	(*)
NINJA 650	17' -18'	RACING	5879	(*)	(*)
NINJA 650	17' -18'	BASIC	6404-6405-6406	(*)	
Z125	17' -18'	RADIKAL	6325	(*)	(*)
Z125	17' -18'	RACING	5879	(*)	(*)
Z125	17' -18'	BASIC	6404-6405-6406	(*)	
Z250SL	15' -16'	ASCENT	6326	(*)	(*)
Z250SL	15' -16'	RADIKAL	6325	(*)	(*)
Z250SL	15' -16'	RACING	5879	(*)	(*)
Z250SL	15' -16'	BASIC	6404-6405-6406	(*)	
Z300	15' -17'	ASCENT	6326	(*)	(*)
Z300	15' -17'	RADIKAL	6325	(*)	(*)
Z300	15' -17'	RACING	5879	(*)	(*)
Z300	15' -17'	BASIC	6404-6405-6406	(*)	
Z650	17' -18'	ASCENT	6326	(*)	(*)
Z650	17' -18'	RADIKAL	6325	(*)	(*)
Z650	17' -18'	RACING	5879	(*)	(*)
Z650	17' -18'	BASIC	6404-6405-6406	(*)	
Z750	04' -06'	ASCENT	6326	(*)	(*)
Z750	04' -06'	RADIKAL	6325	(*)	(*)
Z750	04' -06'	RACING	5879	(*)	(*)
Z750	04' -06'	BASIC	6404-6405-6406	(*)	
Z750	07' -12'	ASCENT	6326	(*)	(*)
Z750	07' -12'	RADIKAL	6325	(*)	(*)
Z750	07' -12'	RACING	5879	(*)	(*)
Z750	07' -12'	BASIC	6404-6405-6406	(*)	
Z750R	11' -12'	ASCENT	6326	(*)	(*)
Z750R	11' -12'	RADIKAL	6325	(*)	(*)
Z750R	11' -12'	RACING	5879	(*)	(*)
Z750R	11' -12'	BASIC	6404-6405-6406	(*)	
Z800/E	13' -16'	ASCENT	6326	(*)	(*)
Z800/E	13' -16'	RADIKAL	6325	(*)	(*)
Z800/E	13' -16'	RACING	5879	(*)	(*)
Z800/E	13' -16'	BASIC	6404-6405-6406	(*)	
Z900	17' -18'	ASCENT	6326	(*)	(*)
Z900	17' -18'	RADIKAL	6325	(*)	(*)
Z900	17' -18'	RACING	5879	(*)	(*)
Z900	17' -18'	BASIC	6404-6405-6406	(*)	
Z900RS	18'	ASCENT	6326	(*)	(*)

MODEL	YEAR	TYPE OF GRIP	REF.	N	
Z900RS	18'	VINTAGE	9190	(*)	(*)
Z900RS	18'	RADIKAL	6325	(*)	(*)
Z900RS	18'	RACING	5879	(*)	(*)
Z900RS	18'	BASIC	6404-6405-6406	(*)	(*)
Z1000	03' - 16'	ASCENT	6326	(*)	(*)
Z1000	03' - 16'	RADIKAL	6325	(*)	(*)
Z1000	03' - 06'	RACING	5879	(*)	(*)
Z1000	03' - 16'	BASIC	6404-6405-6406	(*)	(*)
Z1000/R	17' -18'	ASCENT	6326	(*)	(*)
Z1000/R	17' -18'	RADIKAL	6325	(*)	(*)
Z1000/R	17' -18'	RACING	5879	(*)	(*)
Z1000/R	17' -18'	BASIC	6404-6405-6406	(*)	(*)
Z1000SX	11' - 18'	ASCENT	6326	(*)	(*)
Z1000SX	11' - 18'	RADIKAL	6325	(*)	(*)
Z1000SX	11' - 18'	RACING	5879	(*)	(*)
Z1000SX	11' - 18'	BASIC	6404-6405-6406	(*)	(*)
ZEPHYR 750	91' - 99'	ASCENT	6326	(*)	(*)
ZEPHYR 750	91' - 99'	RADIKAL	6325	(*)	(*)
ZEPHYR 750	91' - 99'	RACING	5879	(*)	(*)
ZEPHYR 750	91' - 99'	BASIC	6404-6405-6406	(*)	(*)
ZR7	99' - 03'	ASCENT	6326	(*)	(*)
ZR7	99' - 03'	RADIKAL	6325	(*)	(*)
ZR7	99' - 03'	RACING	5879	(*)	(*)
ZR7	99' - 03'	BASIC	6404-6405-6406	(*)	(*)
ZR7S	01' - 03'	ASCENT	6326	(*)	(*)
ZR7S	01' - 03'	RADIKAL	6325	(*)	(*)
ZR7S	01' - 03'	RACING	5879	(*)	(*)
ZR7S	01' - 03'	BASIC	6404-6405-6406	(*)	(*)
VERSYS-X 300	17' -18'	ASCENT	6326	(*)	(*)
VERSYS-X 300	17' -18'	RADIKAL	6325	(*)	(*)
VERSYS-X 300	17' -18'	RACING	5879	(*)	(*)
VERSYS-X 300	17' -18'	BASIC	6404-6405-6406	(*)	(*)
VERSYS 650	06' - 18'	ASCENT	6326	(*)	(*)
VERSYS 650	06' - 18'	RADIKAL	6325	(*)	(*)
VERSYS 650	06' - 18'	RACING	5879	(*)	(*)
VERSYS 650	06' - 18'	BASIC	6404-6405-6406	(*)	(*)
VERSYS 1000	12' - 18'	ASCENT	6326	(*)	(*)
VERSYS 1000	12' - 18'	RADIKAL	6325	(*)	(*)
VERSYS 1000	12' - 18'	RACING	5879	(*)	(*)
VERSYS 1000	12' - 18'	BASIC	6404-6405-6406	(*)	(*)
VULCAN S	15' - 18'	ASCENT	6326	(*)	(*)
VULCAN S	15' - 18'	RADIKAL	6325	(*)	(*)

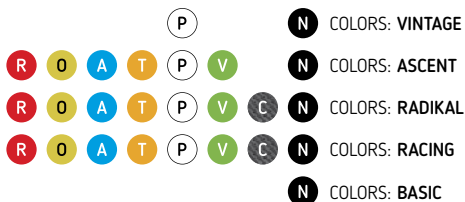

(*) Check price with your distributor.

IMPORTANT: Indicate code color after part#. Example: 0973A.

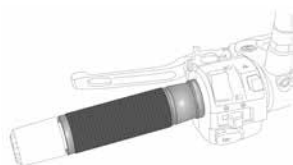

ASCENT / VINTAGE

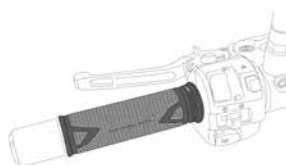

RADIKAL

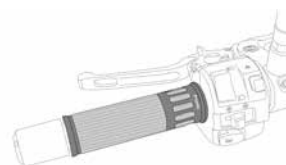

RACING

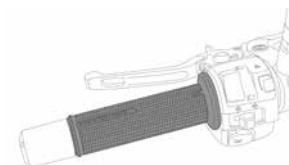

BASIC

MODEL	YEAR	TYPE OF GRIP	REF.	N	R O A T N P V C
VULCAN S	15' - 18'	RACING	5879	(*)	(*)
VULCAN S	15' - 18'	BASIC	6404-6405-6406	(*)	
VULCAN S CAFE	17' -18'	ASCENT	6326	(*)	(*)
VULCAN S CAFE	17' -18'	RADIKAL	6325	(*)	(*)
VULCAN S CAFE	17' -18'	RACING	5879	(*)	(*)
VULCAN S CAFE	17' -18'	BASIC	6404-6405-6406	(*)	
ZX-6R	94' - 16'	ASCENT	6326	(*)	(*)
ZX-6R	94' - 16'	RADIKAL	6325	(*)	(*)
ZX-6R	94' - 16'	RACING	5879	(*)	(*)
ZX-6R	94' - 16'	BASIC	6404-6405-6406	(*)	
ZX-6R 636	13' - 16'	ASCENT	6326	(*)	(*)
ZX-6R 636	13' - 16'	RADIKAL	6325	(*)	(*)
ZX-6R 636	13' - 16'	RACING	5879	(*)	(*)
ZX-6R 636	13' - 16'	BASIC	6404-6405-6406	(*)	
ZX-9R	98' - 04'	ASCENT	6326	(*)	(*)
ZX-9R	98' - 04'	RADIKAL	6325	(*)	(*)
ZX-9R	98' - 04'	RACING	5879	(*)	(*)
ZX-9R	98' - 04'	BASIC	6404-6405-6406	(*)	
ZX-10R	04' - 17'	ASCENT	6326	(*)	(*)
ZX-10R	04' - 17'	RADIKAL	6325	(*)	(*)
ZX-10R	04' - 17'	RACING	5879	(*)	(*)
ZX-10R	04' - 17'	BASIC	6404-6405-6406	(*)	
ZX-10RR	17' -18'	ASCENT	6326	(*)	(*)
ZX-10RR	17' -18'	RADIKAL	6325	(*)	(*)
ZX-10RR	17' -18'	RACING	5879	(*)	(*)
ZX-10RR	17' -18'	BASIC	6404-6405-6406	(*)	
ZX-12R	00' - 06'	ASCENT	6326	(*)	(*)
ZX-12R	00' - 06'	RADIKAL	6325	(*)	(*)
ZX-12R	00' - 06'	RACING	5879	(*)	(*)
ZX-12R	00' - 06'	BASIC	6404-6405-6406	(*)	
ZZR600	93' - 06'	ASCENT	6326	(*)	(*)
ZZR600	93' - 06'	RADIKAL	6325	(*)	(*)
ZZR600	93' - 06'	RACING	5879	(*)	(*)
ZZR600	93' - 06'	BASIC	6404-6405-6406	(*)	
ZZR1400	12' - 18'	ASCENT	6326	(*)	(*)
ZZR1400	12' - 18'	RADIKAL	6325	(*)	(*)
ZZR1400	12' - 18'	RACING	5879	(*)	(*)
ZZR1400	12' - 18'	BASIC	6404-6405-6406	(*)	
ZZR1400S	16' - 18'	ASCENT	6326	(*)	(*)

MODEL	YEAR	TYPE OF GRIP	REF.	N	
ZZR1400S	16' - 18'	RADIKAL	6325	(*)	(*)
ZZR1400S	16' - 18'	RACING	5879	(*)	(*)
ZZR1400S	16' - 18'	BASIC	6404-6405-6406	(*)	(*)
KTM					
125 DUKE	14' - 18'	RADIKAL	6325	(*)	(*)
125 DUKE	14' - 18'	RACING	5879	(*)	(*)
125 DUKE	14' - 18'	BASIC	6404-6405-6406	(*)	(*)
RC125/390	14' - 18'	RADIKAL	6325	(*)	(*)
RC125/390	14' - 18'	RACING	5879	(*)	(*)
RC125/390	14' - 18'	BASIC	6404-6405-6406	(*)	(*)
200 DUKE	12' - 15'	RADIKAL	6325	(*)	(*)
200 DUKE	12' - 15'	RACING	5879	(*)	(*)
200 DUKE	12' - 15'	BASIC	6404-6405-6406	(*)	(*)
390 DUKE	13' - 18'	RADIKAL	6325	(*)	(*)
390 DUKE	13' - 18'	RACING	5879	(*)	(*)
390 DUKE	13' - 18'	BASIC	6404-6405-6406	(*)	(*)
690 DUKE	16' - 18'	RADIKAL	6325	(*)	(*)
690 DUKE	16' - 18'	RACING	5879	(*)	(*)
690 DUKE	16' - 18'	BASIC	6404-6405-6406	(*)	(*)
690 DUKE R	16' - 17'	RADIKAL	6325	(*)	(*)
690 DUKE R	16' - 17'	RACING	5879	(*)	(*)
690 DUKE R	16' - 17'	BASIC	6404-6405-6406	(*)	(*)
790 DUKE	18'	RADIKAL	6325	(*)	(*)
790 DUKE	18'	RACING	5879	(*)	(*)
790 DUKE	18'	BASIC	6404-6405-6406	(*)	(*)
KYMCO					
SUPERDINK 125i/300i	09' - 18'	ASCENT	6326	(*)	(*)
SUPERDINK 125i/300i	09' - 18'	RADIKAL	6325	(*)	(*)
SUPERDINK 125i/300i	09' - 18'	RACING	5879	(*)	(*)
SUPERDINK 125i/300i	09' - 18'	BASIC	6404-6405-6406	(*)	(*)
DOWNTOWN 125i /300i	09' - 18'	ASCENT	6326	(*)	(*)
DOWNTOWN 125i /300i	09' - 18'	RADIKAL	6325	(*)	(*)
DOWNTOWN 125i /300i	09' - 18'	RACING	5879	(*)	(*)
DOWNTOWN 125i /300i	09' - 18'	BASIC	6404-6405-6406	(*)	(*)
NEW DOWNTOWN 125i/350i	15' - 18'	ASCENT	6326	(*)	(*)
NEW DOWNTOWN 125i/350i	15' - 18'	RADIKAL	6325	(*)	(*)
NEW DOWNTOWN 125i/350i	15' - 18'	RACING	5879	(*)	(*)
NEW DOWNTOWN 125i/350i	15' - 18'	BASIC	6404-6405-6406	(*)	(*)
NUEVO SUPERDINK 125i/350i	15' - 18'	ASCENT	6326	(*)	(*)
NUEVO SUPERDINK 125i/350i	15' - 18'	RADIKAL	6325	(*)	(*)
NUEVO SUPERDINK 125i/350i	15' - 18'	RACING	5879	(*)	(*)
NUEVO SUPERDINK 125i/350i	15' - 18'	BASIC	6404-6405-6406	(*)	(*)

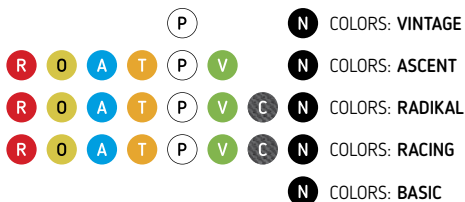

(*) Check price with your distributor.

IMPORTANT: Indicate code color after part#. Example: 0973A.

GRIPS

HI-TECH PARTS | TYPE OF GRIPS:

2019
MODELS:
www.puig.tv

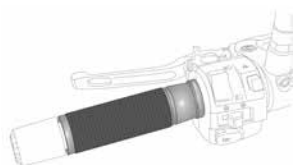

ASCENT / VINTAGE

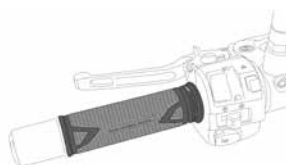

RADIKAL

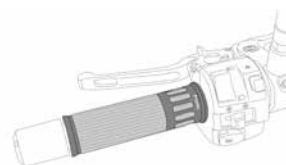

RACING

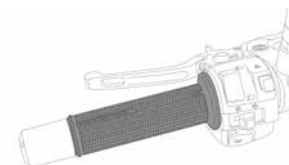

BASIC

MODEL	YEAR	TYPE OF GRIP	REF.	N	R O A T N P V C
X-TOWN 125/300	16' - 18'	ASCENT	6326	(*)	(*)
X-TOWN 125/300	16' - 18'	RADIKAL	6325	(*)	(*)
X-TOWN 125/300	16' - 18'	RACING	5879	(*)	(*)
X-TOWN 125/300	16' - 18'	BASIC	6404-6405-6406	(*)	(*)
NUEVO GRAN DINK 125/300	16' - 18'	ASCENT	6326	(*)	(*)
NUEVO GRAN DINK 125/300	16' - 18'	RADIKAL	6325	(*)	(*)
NUEVO GRAN DINK 125/300	16' - 18'	RACING	5879	(*)	(*)
NUEVO GRAN DINK 125/300	16' - 18'	BASIC	6404-6405-6406	(*)	(*)
GRAND DINK 50/125i/300i	12' - 18'	ASCENT	6326	(*)	(*)
GRAND DINK 50/125i/300i	12' - 18'	RADIKAL	6325	(*)	(*)
GRAND DINK 50/125i/300i	12' - 18'	RACING	5879	(*)	(*)
GRAND DINK 50/125i/300i	12' - 18'	BASIC	6404-6405-6406	(*)	(*)
YAGER GT 125i/300i	13' - 18'	ASCENT	6326	(*)	(*)
YAGER GT 125i/300i	13' - 18'	RADIKAL	6325	(*)	(*)
YAGER GT 125i/300i	13' - 18'	RACING	5879	(*)	(*)
YAGER GT 125i/300i	13' - 18'	BASIC	6404-6405-6406	(*)	(*)
K-XCT 125i/300i	13' - 18'	ASCENT	6326	(*)	(*)
K-XCT 125i/300i	13' - 18'	RADIKAL	6325	(*)	(*)
K-XCT 125i/300i	13' - 18'	RACING	5879	(*)	(*)
K-XCT 125i/300i	13' - 18'	BASIC	6404-6405-6406	(*)	(*)
XCITING 400i	14' - 18'	ASCENT	6326	(*)	(*)
XCITING 400i	14' - 18'	RADIKAL	6325	(*)	(*)
XCITING 400i	14' - 18'	RACING	5879	(*)	(*)
XCITING 400i	14' - 18'	BASIC	6404-6405-6406	(*)	(*)
SUZUKI					
B-KING	08' - 11'	ASCENT	6326	(*)	(*)
B-KING	08' - 11'	RADIKAL	6325	(*)	(*)
B-KING	08' - 11'	RACING	5879	(*)	(*)
B-KING	08' - 11'	BASIC	6404-6405-6406	(*)	(*)
BURGMAN 400	10' - 18'	ASCENT	6326	(*)	(*)
BURGMAN 400	10' - 18'	RADIKAL	6325	(*)	(*)
BURGMAN 400	10' - 18'	RACING	5879	(*)	(*)
BURGMAN 400	10' - 18'	BASIC	6404-6405-6406	(*)	(*)
BURGMAM 650/EXECUTIVE	13' - 18'	ASCENT	6326	(*)	(*)
BURGMAM 650/EXECUTIVE	13' - 18'	RADIKAL	6325	(*)	(*)
BURGMAM 650/EXECUTIVE	13' - 18'	RACING	5879	(*)	(*)
BURGMAM 650/EXECUTIVE	13' - 18'	BASIC	6404-6405-6406	(*)	(*)
DL250 V-STROM	17' - 18'	ASCENT	6326	(*)	(*)
DL650 V-STROM	04' - 18'	ASCENT	6326	(*)	(*)

MODEL	YEAR	TYPE OF GRIP	REF.	N	
DL650 V-STROM	04' - 18'	RADIKAL	6325	(*)	(*)
DL650 V-STROM	04' - 18'	RACING	5879	(*)	(*)
DL650 V-STROM	04' - 18'	BASIC	6404-6405-6406	(*)	(*)
DL650XT V-STROM	15' - 18'	ASCENT	6326	(*)	(*)
DL650XT V-STROM	15' - 18'	RADIKAL	6325	(*)	(*)
DL650XT V-STROM	15' - 18'	RACING	5879	(*)	(*)
DL650XT V-STROM	15' - 18'	BASIC	6404-6405-6406	(*)	(*)
DL1000 V-STROM	02' - 07'	ASCENT	6326	(*)	(*)
DL1000 V-STROM	02' - 07'	RADIKAL	6325	(*)	(*)
DL1000 V-STROM	02' - 07'	RACING	5879	(*)	(*)
DL1000 V-STROM	02' - 07'	BASIC	6404-6405-6406	(*)	(*)
DL1000 V-STROM	14' - 18'	ASCENT	6326	(*)	(*)
DL1000 V-STROM	14' - 18'	RADIKAL	6325	(*)	(*)
DL1000 V-STROM	14' - 18'	RACING	5879	(*)	(*)
DL1000 V-STROM	14' - 18'	BASIC	6404-6405-6406	(*)	(*)
DL1000XT V-STROM	17' - 18'	ASCENT	6326	(*)	(*)
DL1000XT V-STROM	17' - 18'	RADIKAL	6325	(*)	(*)
DL1000XT V-STROM	17' - 18'	RACING	5879	(*)	(*)
DL1000XT V-STROM	17' - 18'	BASIC	6404-6405-6406	(*)	(*)
GSF650 BANDIT	07' - 11'	ASCENT	6326	(*)	(*)
GSF650 BANDIT	07' - 11'	RADIKAL	6325	(*)	(*)
GSF650 BANDIT	07' - 11'	RACING	5879	(*)	(*)
GSF650 BANDIT	07' - 11'	BASIC	6404-6405-6406	(*)	(*)
GSF650S BANDIT	07' - 14'	ASCENT	6326	(*)	(*)
GSF650S BANDIT	07' - 14'	RADIKAL	6325	(*)	(*)
GSF650S BANDIT	07' - 14'	RACING	5879	(*)	(*)
GSF650S BANDIT	07' - 14'	BASIC	6404-6405-6406	(*)	(*)
GSF1200 BANDIT	01' - 06'	ASCENT	6326	(*)	(*)
GSF1200 BANDIT	01' - 06'	RADIKAL	6325	(*)	(*)
GSF1200 BANDIT	01' - 06'	RACING	5879	(*)	(*)
GSF1200 BANDIT	01' - 06'	BASIC	6404-6405-6406	(*)	(*)
GSF1250 BANDIT	07' - 13'	ASCENT	6326	(*)	(*)
GSF1250 BANDIT	07' - 13'	RADIKAL	6325	(*)	(*)
GSF1250 BANDIT	07' - 13'	RACING	5879	(*)	(*)
GSF1250 BANDIT	07' - 13'	BASIC	6404-6405-6406	(*)	(*)
GSF1250S BANDIT	07' - 13'	ASCENT	6326	(*)	(*)
GSF1250S BANDIT	07' - 13'	RADIKAL	6325	(*)	(*)
GSF1250S BANDIT	07' - 13'	RACING	5879	(*)	(*)
GSF1250S BANDIT	07' - 13'	BASIC	6404-6405-6406	(*)	(*)
GSF1250S BANDIT	15' - 17'	ASCENT	6326	(*)	(*)
GSF1250S BANDIT	15' - 17'	RADIKAL	6325	(*)	(*)
GSF1250S BANDIT	15' - 17'	RACING	5879	(*)	(*)

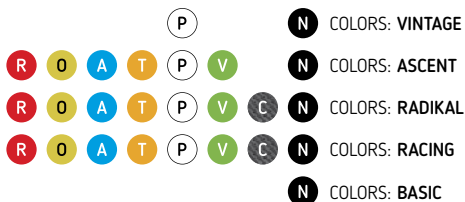

(*) Check price with your distributor.

IMPORTANT: Indicate code color after part#. Example: 0973A.

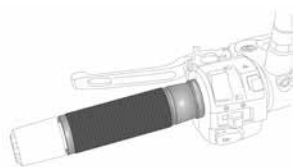

ASCENT / VINTAGE

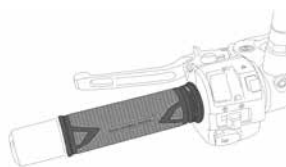

RADIKAL

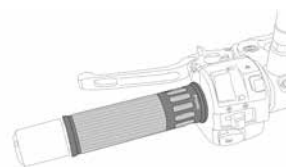

RACING

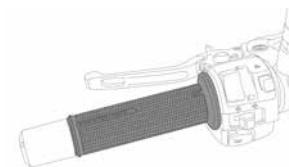

BASIC

MODEL	YEAR	TYPE OF GRIP	REF.	N	R O A T N P V C
GSF1250S BANDIT	15' - 17'	BASIC	6404-6405-6406	(*)	
GSR600	06' - 11'	ASCENT	6326	(*)	(*)
GSR600	06' - 11'	RADIKAL	6325	(*)	(*)
GSR600	06' - 11'	RACING	5879	(*)	(*)
GSR600	06' - 11'	BASIC	6404-6405-6406	(*)	
GSR750	11' - 16'	ASCENT	6326	(*)	(*)
GSR750	11' - 16'	RADIKAL	6325	(*)	(*)
GSR750	11' - 16'	RACING	5879	(*)	(*)
GSR750	11' - 16'	BASIC	6404-6405-6406	(*)	
GSX-S125	17' - 18'	ASCENT	6326	(*)	(*)
GSX-S125	17' - 18'	RADIKAL	6325	(*)	(*)
GSX-S125	17' - 18'	RACING	5879	(*)	(*)
GSX-S125	17' - 18'	BASIC	6404-6405-6406	(*)	
GSX-S750	17' - 18'	ASCENT	6326	(*)	(*)
GSX-S750	17' - 18'	RADIKAL	6325	(*)	(*)
GSX-S750	17' - 18'	RACING	5879	(*)	(*)
GSX-S750	17' - 18'	BASIC	6404-6405-6406	(*)	
GSX650F	08' - 16'	ASCENT	6326	(*)	(*)
GSX650F	08' - 16'	RADIKAL	6325	(*)	(*)
GSX650F	08' - 16'	RACING	5879	(*)	(*)
GSX650F	08' - 16'	BASIC	6404-6405-6406	(*)	
GSX1250F	10' - 17'	ASCENT	6326	(*)	(*)
GSX1250F	10' - 17'	RADIKAL	6325	(*)	(*)
GSX1250F	10' - 17'	RACING	5879	(*)	(*)
GSX1250F	10' - 17'	BASIC	6404-6405-6406	(*)	
GSX1400	01' - 06'	ASCENT	6326	(*)	(*)
GSX1400	01' - 06'	RADIKAL	6325	(*)	(*)
GSX1400	01' - 06'	RACING	5879	(*)	(*)
GSX1400	01' - 06'	BASIC	6404-6405-6406	(*)	
GSX-R125	17' - 18'	ASCENT	6326	(*)	(*)
GSX-R125	17' - 18'	RADIKAL	6325	(*)	(*)
GSX-R125	17' - 18'	RACING	5879	(*)	(*)
GSX-R125	17' - 18'	BASIC	6404-6405-6406	(*)	
GSX-R250	17' - 18'	ASCENT	6326	(*)	(*)
GSX-R250	17' - 18'	RADIKAL	6325	(*)	(*)
GSX-R250	17' - 18'	RACING	5879	(*)	(*)
GSX-R250	17' - 18'	BASIC	6404-6405-6406	(*)	
GSX-R600	96' - 17'	ASCENT	6326	(*)	(*)
GSX-R600	96' - 17'	RADIKAL	6325	(*)	(*)

MODEL	YEAR	TYPE OF GRIP	REF.	N	
GSX-R600	96' - 17'	RACING	5879	(*)	(*)
GSX-R600	96' - 17'	BASIC	6404-6405-6406	(*)	(*)
GSX-R750	96' - 17'	ASCENT	6326	(*)	(*)
GSX-R750	96' - 17'	RADIKAL	6325	(*)	(*)
GSX-R750	96' - 17'	RACING	5879	(*)	(*)
GSX-R750	96' - 17'	BASIC	6404-6405-6406	(*)	(*)
GSX-R1000	01' - 16'	ASCENT	6326	(*)	(*)
GSX-R1000	01' - 16'	RADIKAL	6325	(*)	(*)
GSX-R1000	01' - 16'	RACING	5879	(*)	(*)
GSX-R1000	01' - 16'	BASIC	6404-6405-6406	(*)	(*)
GSX-R1000/R	17' - 18'	ASCENT	6326	(*)	(*)
GSX-R1000/R	17' - 18'	RADIKAL	6325	(*)	(*)
GSX-R1000/R	17' - 18'	RACING	5879	(*)	(*)
GSX-R1000/R	17' - 18'	BASIC	6404-6405-6406	(*)	(*)
GSX-S1000	15' - 18'	ASCENT	6326	(*)	(*)
GSX-S1000	15' - 18'	RADIKAL	6325	(*)	(*)
GSX-S1000	15' - 18'	RACING	5879	(*)	(*)
GSX-S1000	15' - 18'	BASIC	6404-6405-6406	(*)	(*)
GSX-S1000F	15' - 18'	ASCENT	6326	(*)	(*)
GSX-S1000F	15' - 18'	RADIKAL	6325	(*)	(*)
GSX-S1000F	15' - 18'	RACING	5879	(*)	(*)
GSX-S1000F	15' - 18'	BASIC	6404-6405-6406	(*)	(*)
GSX-R1300 HAYABUSA	99' - 07'	ASCENT	6326	(*)	(*)
GSX-R1300 HAYABUSA	99' - 07'	RADIKAL	6325	(*)	(*)
GSX-R1300 HAYABUSA	99' - 07'	RACING	5879	(*)	(*)
GSX-R1300 HAYABUSA	99' - 07'	BASIC	6404-6405-6406	(*)	(*)
INAZUMA	13' - 17'	ASCENT	6326	(*)	(*)
INAZUMA	13' - 17'	RADIKAL	6325	(*)	(*)
INAZUMA	13' - 17'	RACING	5879	(*)	(*)
INAZUMA	13' - 17'	BASIC	6404-6405-6406	(*)	(*)
SFV650 GLADIUS	09' - 15'	ASCENT	6326	(*)	(*)
SFV650 GLADIUS	09' - 15'	RADIKAL	6325	(*)	(*)
SFV650 GLADIUS	09' - 15'	RACING	5879	(*)	(*)
SFV650 GLADIUS	09' - 15'	BASIC	6404-6405-6406	(*)	(*)
SV650	99' - 08'	ASCENT	6326	(*)	(*)
SV650	99' - 08'	RADIKAL	6325	(*)	(*)
SV650	99' - 08'	RACING	5879	(*)	(*)
SV650	99' - 08'	BASIC	6404-6405-6406	(*)	(*)
SV650S	99' - 08'	ASCENT	6326	(*)	(*)
SV650S	99' - 08'	RADIKAL	6325	(*)	(*)
SV650S	99' - 08'	RACING	5879	(*)	(*)
SV650S	99' - 08'	BASIC	6404-6405-6406	(*)	(*)

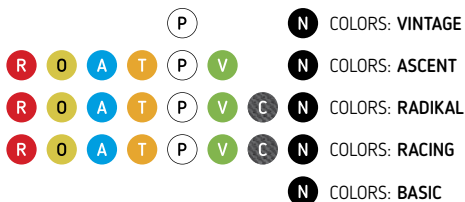

(*) Check price with your distributor.

IMPORTANT: Indicate code color after part#. Example: 0973A.

GRIPS

HI-TECH PARTS | TYPE OF GRIPS:

2019
MODELS:
www.puig.tv

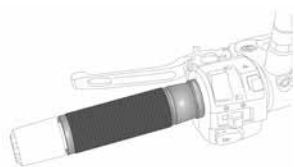

ASCENT / VINTAGE

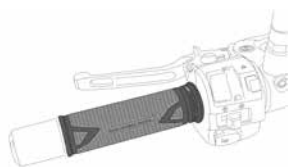

RADIKAL

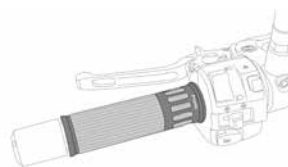

RACING

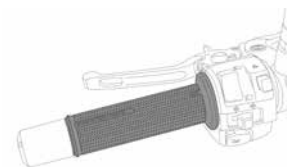

BASIC

MODEL	YEAR	TYPE OF GRIP	REF.	N	R O A T N P V C
SV650	16' - 18'	ASCENT	6326	(*)	(*)
SV650	16' - 18'	RADIKAL	6325	(*)	(*)
SV650	16' - 18'	RACING	5879	(*)	(*)
SV650	16' - 18'	BASIC	6404-6405-6406	(*)	
SV650X	18'	ASCENT	6326	(*)	(*)
SV650X	18'	RADIKAL	6325	(*)	(*)
SV650X	18'	RACING	5879	(*)	(*)
SV650X	18'	BASIC	6404-6405-6406	(*)	
SV1000/S	03' - 07'	ASCENT	6326	(*)	(*)
SV1000/S	03' - 07'	RADIKAL	6325	(*)	(*)
SV1000/S	03' - 07'	RACING	5879	(*)	(*)
SV1000/S	03' - 07'	BASIC	6404-6405-6406	(*)	
TRIUMPH					
BONNEVILLE T100	05' - 16'	RADIKAL	6325	(*)	(*)
BONNEVILLE T100	05' - 16'	RACING	5879	(*)	(*)
BONNEVILLE T100	05' - 16'	BASIC	6404-6405-6406	(*)	
BONNEVILLE T120	16' - 18'	RADIKAL	6325	(*)	(*)
BONNEVILLE T120	16' - 18'	RACING	5879	(*)	(*)
BONNEVILLE T120	16' - 18'	BASIC	6404-6405-6406	(*)	
BONNEVILLE BOBBER	17'	ASCENT	6326	(*)	(*)
BONNEVILLE BOBBER	17' - 18'	VINTAGE	9190	(*)	(*)
BONNEVILLE BOBBER	17'	RADIKAL	6325	(*)	(*)
BONNEVILLE BOBBER	17'	RACING	5879	(*)	(*)
BONNEVILLE BOBBER	17'	BASIC	6404-6405-6406	(*)	
DAYTONA 600	03' - 04'	ASCENT	6326	(*)	(*)
DAYTONA 600	03' - 04'	RADIKAL	6325	(*)	(*)
DAYTONA 600	03' - 04'	RACING	5879	(*)	(*)
DAYTONA 600	03' - 04'	BASIC	6404-6405-6406	(*)	
DAYTONA 650	05'	ASCENT	6326	(*)	(*)
DAYTONA 650	05'	RADIKAL	6325	(*)	(*)
DAYTONA 650	05'	RACING	5879	(*)	(*)
DAYTONA 650	05'	BASIC	6404-6405-6406	(*)	
DAYTONA 675	06' - 16'	ASCENT	6326	(*)	(*)
DAYTONA 675	06' - 16'	RADIKAL	6325	(*)	(*)
DAYTONA 675	06' - 16'	RACING	5879	(*)	(*)
DAYTONA 675	06' - 16'	BASIC	6404-6405-6406	(*)	
DAYTONA 675 R	13' - 16'	ASCENT	6326	(*)	(*)
DAYTONA 675 R	13' - 16'	RADIKAL	6325	(*)	(*)
DAYTONA 675 R	13' - 16'	RACING	5879	(*)	(*)

MODEL	YEAR	TYPE OF GRIP	REF.	N	
DAYTONA 675 R	13' - 16'	BASIC	6404-6405-6406	(*)	
DAYTONA 955i	04' - 06'	ASCENT	6326	(*)	(*)
DAYTONA 955i	04' - 06'	RADIKAL	6325	(*)	(*)
DAYTONA 955i	04' - 06'	RACING	5879	(*)	(*)
DAYTONA 955i	04' - 06'	BASIC	6404-6405-6406	(*)	
SPEED TRIPLE	11' - 18'	ASCENT	6326	(*)	(*)
SPEED TRIPLE	11' - 18'	RADIKAL	6325	(*)	(*)
SPEED TRIPLE	11' - 18'	RACING	5879	(*)	(*)
SPEED TRIPLE	11' - 18'	BASIC	6404-6405-6406	(*)	
SPEED TRIPLE R	12' - 18'	ASCENT	6326	(*)	(*)
SPEED TRIPLE R	12' - 18'	RADIKAL	6325	(*)	(*)
SPEED TRIPLE R	12' - 18'	RACING	5879	(*)	(*)
SPEED TRIPLE R	12' - 18'	BASIC	6404-6405-6406	(*)	
STREET CUP	17' - 18'	RADIKAL	6325	(*)	(*)
STREET CUP	17' - 18'	RACING	5879	(*)	(*)
STREET CUP	17' - 18'	BASIC	6404-6405-6406	(*)	
STREET SCRAMBLER	17'	RADIKAL	6325	(*)	(*)
STREET SCRAMBLER	17'	RACING	5879	(*)	(*)
STREET SCRAMBLER	17'	BASIC	6404-6405-6406	(*)	
STREET TRIPLE	07' - 18'	ASCENT	6326	(*)	(*)
STREET TRIPLE	07' - 18'	RADIKAL	6325	(*)	(*)
STREET TRIPLE	07' - 18'	RACING	5879	(*)	(*)
STREET TRIPLE	07' - 18'	BASIC	6404-6405-6406	(*)	
STREET TRIPLE R	08' - 17'	ASCENT	6326	(*)	(*)
STREET TRIPLE R	08' - 17'	RADIKAL	6325	(*)	(*)
STREET TRIPLE R	08' - 17'	RACING	5879	(*)	(*)
STREET TRIPLE R	08' - 17'	BASIC	6404-6405-6406	(*)	
STREET TWIN	16' - 18'	RADIKAL	6325	(*)	(*)
STREET TWIN	16' - 18'	RACING	5879	(*)	(*)
STREET TWIN	16' - 18'	BASIC	6404-6405-6406	(*)	
THRUXTON	04' - 15'	ASCENT	6326	(*)	(*)
THRUXTON	04' - 15'	RADIKAL	6325	(*)	(*)
THRUXTON	04' - 15'	RACING	5879	(*)	(*)
THRUXTON	04' - 15'	BASIC	6404-6405-6406	(*)	
THRUXTON 1200/R	16' - 18'	ASCENT	6326	(*)	(*)
THRUXTON 1200/R	16' - 18'	RADIKAL	6325	(*)	(*)
THRUXTON 1200/R	16' - 18'	RACING	5879	(*)	(*)
THRUXTON 1200/R	16' - 18'	BASIC	6404-6405-6406	(*)	
TIGER 800/XC	11' - 14'	ASCENT	6326	(*)	(*)
TIGER 800/XC	11' - 14'	RADIKAL	6325	(*)	(*)
TIGER 800/XC	11' - 14'	RACING	5879	(*)	(*)
TIGER 800/XC	11' - 14'	BASIC	6404-6405-6406	(*)	

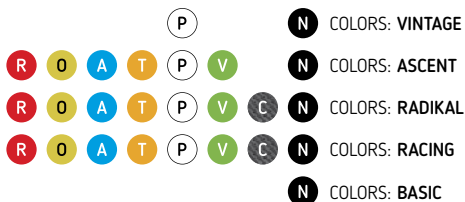

IMPORTANT: Indicate code color after part#. Example: 0973A.

GRIPS

HI-TECH PARTS | TYPE OF GRIPS:

2019
MODELS:
www.puig.tv

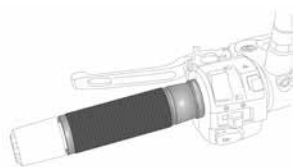

ASCENT / VINTAGE

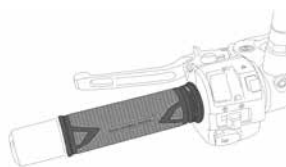

RADIKAL

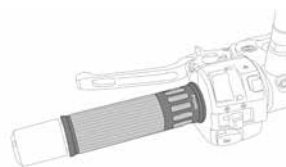

RACING

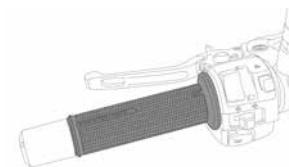

BASIC

MODEL	YEAR	TYPE OF GRIP	REF.	N	R O A T N P V C
TIGER 800 XC/XCX/XCA/XR/XRX/XRT	15' - 18'	ASCENT	6326	(*)	(*)
TIGER 800 XC/XCX/XCA/XR/XRX/XRT	15' - 18'	RADIKAL	6325	(*)	(*)
TIGER 800 XC/XCX/XCA/XR/XRX/XRT	15' - 18'	RACING	5879	(*)	(*)
TIGER 800 XC/XCX/XCA/XR/XRX/XRT	15' - 18'	BASIC	6404-6405-6406	(*)	
TIGER 1050	07' - 13'	ASCENT	6326	(*)	(*)
TIGER 1050	07' - 13'	RADIKAL	6325	(*)	(*)
TIGER 1050	07' - 13'	RACING	5879	(*)	(*)
TIGER 1050	07' - 13'	BASIC	6404-6405-6406	(*)	
TIGER SPORT	13' - 18'	ASCENT	6326	(*)	(*)
TIGER SPORT	13' - 18'	RADIKAL	6325	(*)	(*)
TIGER SPORT	13' - 18'	RACING	5879	(*)	(*)
TIGER SPORT	13' - 18'	BASIC	6404-6405-6406	(*)	
TIGER EXPLORER	12' - 15'	ASCENT	6326	(*)	(*)
TIGER EXPLORER	12' - 15'	RADIKAL	6325	(*)	(*)
TIGER EXPLORER	12' - 15'	RACING	5879	(*)	(*)
TIGER EXPLORER	12' - 15'	BASIC	6404-6405-6406	(*)	
TIGER EXPLORER XC	13' - 15'	ASCENT	6326	(*)	(*)
TIGER EXPLORER XC	13' - 15'	RADIKAL	6325	(*)	(*)
TIGER EXPLORER XC	13' - 15'	RACING	5879	(*)	(*)
TIGER EXPLORER XC	13' - 15'	BASIC	6404-6405-6406	(*)	
TIGER EXPLORER XC/XR/XRX/XRT/XCX/XCA	16' - 17'	RADIKAL	6325	(*)	(*)
TIGER EXPLORER XC/XR/XRX/XRT/XCX/XCA	16' - 17'	RACING	5879	(*)	(*)
TIGER EXPLORER XC/XR/XRX/XRT/XCX/XCA	16' - 17'	BASIC	6404-6405-6406	(*)	
YAMAHA					
FJR1300	01' - 05'	ASCENT	6326	(*)	(*)
FJR1300	01' - 05'	RADIKAL	6325	(*)	(*)
FJR1300	01' - 05'	RACING	5879	(*)	(*)
FJR1300	01' - 05'	BASIC	6404-6405-6406	(*)	
FJR1300A/AS	06' - 12'	ASCENT	6326	(*)	(*)
FJR1300A/AS	06' - 12'	RADIKAL	6325	(*)	(*)
FJR1300A/AS	06' - 12'	RACING	5879	(*)	(*)
FJR1300A/AS	06' - 12'	BASIC	6404-6405-6406	(*)	
FJR1300A/AS	13' - 18'	ASCENT	6326	(*)	(*)
FJR1300A/AS	13' - 18'	RADIKAL	6325	(*)	(*)
FJR1300A/AS	13' - 18'	RACING	5879	(*)	(*)
FJR1300A/AS	13' - 18'	BASIC	6404-6405-6406	(*)	
FZ1	06' - 15'	ASCENT	6326	(*)	(*)
FZ1	06' - 15'	RADIKAL	6325	(*)	(*)
FZ1	06' - 15'	RACING	5879	(*)	(*)

MODEL	YEAR	TYPE OF GRIP	REF.	N	
FZ1	06' - 15'	BASIC	6404-6405-6406	(*)	
FZ1 FAZER	06' - 15'	ASCENT	6326	(*)	(*)
FZ1 FAZER	06' - 15'	RADIKAL	6325	(*)	(*)
FZ1 FAZER	06' - 15'	RACING	5879	(*)	(*)
FZ1 FAZER	06' - 15'	BASIC	6404-6405-6406	(*)	
FZ6	04' - 06'	ASCENT	6326	(*)	(*)
FZ6	04' - 06'	RADIKAL	6325	(*)	(*)
FZ6	04' - 06'	RACING	5879	(*)	(*)
FZ6	04' - 06'	BASIC	6404-6405-6406	(*)	
FZ6 S2	07' - 10'	ASCENT	6326	(*)	(*)
FZ6 S2	07' - 10'	RADIKAL	6325	(*)	(*)
FZ6 S2	07' - 10'	RACING	5879	(*)	(*)
FZ6 S2	07' - 10'	BASIC	6404-6405-6406	(*)	
FZ6 FAZER	07' - 08'	ASCENT	6326	(*)	(*)
FZ6 FAZER	07' - 08'	RADIKAL	6325	(*)	(*)
FZ6 FAZER	07' - 08'	RACING	5879	(*)	(*)
FZ6 FAZER	07' - 08'	BASIC	6404-6405-6406	(*)	
FZ6 FAZER S2	07' - 10'	ASCENT	6326	(*)	(*)
FZ6 FAZER S2	07' - 10'	RADIKAL	6325	(*)	(*)
FZ6 FAZER S2	07' - 10'	RACING	5879	(*)	(*)
FZ6 FAZER S2	07' - 10'	BASIC	6404-6405-6406	(*)	
FZ8	10' - 16'	ASCENT	6326	(*)	(*)
FZ8	10' - 16'	RADIKAL	6325	(*)	(*)
FZ8	10' - 16'	RACING	5879	(*)	(*)
FZ8	10' - 16'	BASIC	6404-6405-6406	(*)	
FZ8 FAZER	10' - 12'	ASCENT	6326	(*)	(*)
FZ8 FAZER	10' - 12'	RADIKAL	6325	(*)	(*)
FZ8 FAZER	10' - 12'	RACING	5879	(*)	(*)
FZ8 FAZER	10' - 12'	BASIC	6404-6405-6406	(*)	
FAZER8	13' - 16'	ASCENT	6326	(*)	(*)
FAZER8	13' - 16'	RADIKAL	6325	(*)	(*)
FAZER8	13' - 16'	RACING	5879	(*)	(*)
FAZER8	13' - 16'	BASIC	6404-6405-6406	(*)	
FZS1000 FAZER	01' - 05'	ASCENT	6326	(*)	(*)
FZS1000 FAZER	01' - 05'	RADIKAL	6325	(*)	(*)
FZS1000 FAZER	01' - 05'	RACING	5879	(*)	(*)
FZS1000 FAZER	01' - 05'	BASIC	6404-6405-6406	(*)	
MT-01	05' - 13'	ASCENT	6326	(*)	(*)
MT-01	05' - 13'	RADIKAL	6325	(*)	(*)
MT-01	05' - 13'	RACING	5879	(*)	(*)
MT-01	05' - 13'	BASIC	6404-6405-6406	(*)	
MT-125	14' - 18'	ASCENT	6326	(*)	(*)

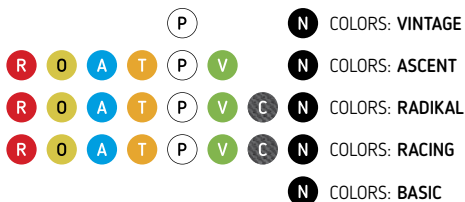

(*) Check price with your distributor.

IMPORTANT: Indicate code color after part#. Example: 0973A.

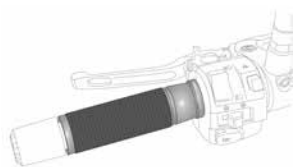

ASCENT / VINTAGE

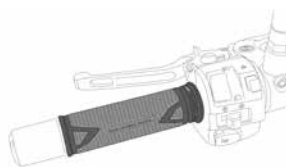

RADIKAL

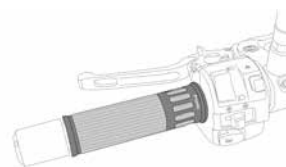



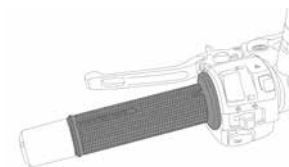





RACING

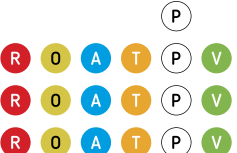

BASIC

MODEL	YEAR	TYPE OF GRIP	REF.	N	R D A T N P V C
MT-125	14' - 18'	RADIKAL	6325	(*)	(*)
MT-125	14' - 18'	RACING	5879	(*)	(*)
MT-125	14' - 18'	BASIC	6404-6405-6406	(*)	
MT-03	16' - 18'	ASCENT	6326	(*)	(*)
MT-03	16' - 18'	RADIKAL	6325	(*)	(*)
MT-03	16' - 18'	RACING	5879	(*)	(*)
MT-03	16' - 18'	BASIC	6404-6405-6406	(*)	
MT-07	14' - 18'	ASCENT	6326	(*)	(*)
MT-07	14' - 18'	RADIKAL	6325	(*)	(*)
MT-07	14' - 18'	RACING	5879	(*)	(*)
MT-07	14' - 18'	BASIC	6404-6405-6406	(*)	
MT-07 TRACER	16' - 18'	ASCENT	6326	(*)	(*)
MT-07 TRACER	16' - 18'	RADIKAL	6325	(*)	(*)
MT-07 TRACER	16' - 18'	RACING	5879	(*)	(*)
MT-07 TRACER	16' - 18'	BASIC	6404-6405-6406	(*)	
MT-09	13' - 18'	ASCENT	6326	(*)	(*)
MT-09	13' - 18'	RADIKAL	6325	(*)	(*)
MT-09	13' - 18'	RACING	5879	(*)	(*)
MT-09	13' - 18'	BASIC	6404-6405-6406	(*)	
MT-09 SP	18'	ASCENT	6326	(*)	(*)
MT-09 SP	18'	RADIKAL	6325	(*)	(*)
MT-09 SP	18'	RACING	5879	(*)	(*)
MT-09 SP	18'	BASIC	6404-6405-6406	(*)	
MT-09 TRACER	15' - 17'	ASCENT	6326	(*)	(*)
MT-09 TRACER	15' - 18'	RADIKAL	6325	(*)	(*)
MT-09 TRACER	15' - 18'	RACING	5879	(*)	(*)
MT-09 TRACER	15' - 18'	BASIC	6404-6405-6406	(*)	
MT-09 TRACER GT	18'	ASCENT	6326	(*)	(*)
MT-09 TRACER GT	18'	RADIKAL	6325	(*)	(*)
MT-09 TRACER GT	18'	RACING	5879	(*)	(*)
MT-09 TRACER GT	18'	BASIC	6404-6405-6406	(*)	
MT-10	16' - 18'	ASCENT	6326	(*)	(*)
MT-10	16' - 18'	RADIKAL	6325	(*)	(*)
MT-10	16' - 18'	RACING	5879	(*)	(*)
MT-10	16' - 18'	BASIC	6404-6405-6406	(*)	
MT-10 SP	17' - 18'	ASCENT	6326	(*)	(*)
MT-10 SP	17' - 18'	RADIKAL	6325	(*)	(*)
MT-10 SP	17' - 18'	RACING	5879	(*)	(*)
MT-10 SP	17' - 18'	BASIC	6404-6405-6406	(*)	

MODEL	YEAR	TYPE OF GRIP	REF.	N	
SCR950	17' - 18'	ASCENT	6326	(*)	(*)
SCR950	17' - 18'	RADIKAL	6325	(*)	(*)
T-MAX 500	08' - 11'	ASCENT	6326	(*)	(*)
T-MAX 500	08' - 11'	RADIKAL	6325	(*)	(*)
T-MAX 500	08' - 11'	RACING	5879	(*)	(*)
T-MAX 500	08' - 11'	BASIC	6404-6405-6406	(*)	(*)
T-MAX 530	12' - 14'	ASCENT	6326	(*)	(*)
T-MAX 530	12' - 14'	RADIKAL	6325	(*)	(*)
T-MAX 530	12' - 14'	RACING	5879	(*)	(*)
T-MAX 530	12' - 14'	BASIC	6404-6405-6406	(*)	(*)
T-MAX 530	15' - 16'	ASCENT	6326	(*)	(*)
T-MAX 530	15' - 16'	RADIKAL	6325	(*)	(*)
T-MAX 530	15' - 16'	RACING	5879	(*)	(*)
T-MAX 530	15' - 16'	BASIC	6404-6405-6406	(*)	(*)
T-MAX 530/DX/SX	17' - 18'	ASCENT	6326	(*)	(*)
T-MAX 530/DX/SX	17' - 18'	RADIKAL	6325	(*)	(*)
T-MAX 530/DX/SX	17' - 18'	RACING	5879	(*)	(*)
T-MAX 530/DX/SX	17' - 18'	BASIC	6404-6405-6406	(*)	(*)
VMAX	09' - 17'	ASCENT	6326	(*)	(*)
VMAX	09' - 17'	RADIKAL	6325	(*)	(*)
VMAX	09' - 17'	RACING	5879	(*)	(*)
VMAX	09' - 17'	BASIC	6404-6405-6406	(*)	(*)
X-MAX 125	06' - 18'	ASCENT	6326	(*)	(*)
X-MAX 125	06' - 18'	RADIKAL	6325	(*)	(*)
X-MAX 125	06' - 18'	RACING	5879	(*)	(*)
X-MAX 125	06' - 18'	BASIC	6404-6405-6406	(*)	(*)
X-MAX 250	10' - 18'	ASCENT	6326	(*)	(*)
X-MAX 250	10' - 18'	RADIKAL	6325	(*)	(*)
X-MAX 250	10' - 18'	RACING	5879	(*)	(*)
X-MAX 250	10' - 18'	BASIC	6404-6405-6406	(*)	(*)
X-MAX 300	17' - 18'	ASCENT	6326	(*)	(*)
X-MAX 300	17' - 18'	RADIKAL	6325	(*)	(*)
X-MAX 300	17' - 18'	RACING	5879	(*)	(*)
X-MAX 300	17' - 18'	BASIC	6404-6405-6406	(*)	(*)
X-MAX 400	13' - 18'	ASCENT	6326	(*)	(*)
X-MAX 400	13' - 18'	RADIKAL	6325	(*)	(*)
X-MAX 400	13' - 18'	RACING	5879	(*)	(*)
X-MAX 400	13' - 18'	BASIC	6404-6405-6406	(*)	(*)
XJ6	09' - 16'	ASCENT	6326	(*)	(*)
XJ6	09' - 16'	RADIKAL	6325	(*)	(*)
XJ6	09' - 16'	RACING	5879	(*)	(*)
XJ6	09' - 16'	BASIC	6404-6405-6406	(*)	(*)



COLORS: VINTAGE

COLORS: ASCENT

COLORS: RADIKAL

COLORS: RACING

COLORS: BASIC

(*) Check price with your distributor.

IMPORTANT: Indicate code color after part#. Example: 0973A.

GRIPS

HI-TECH PARTS | TYPE OF GRIPS:

2019
MODELS:
www.puig.tv

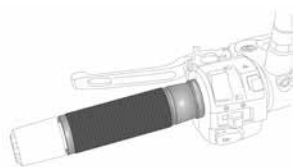

ASCENT / VINTAGE

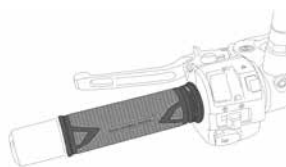

RADIKAL

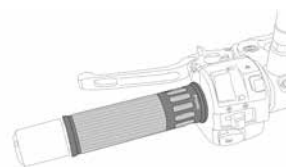

RACING

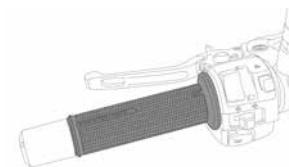

BASIC

MODEL	YEAR	TYPE OF GRIP	REF.	N	R O A T N P V C
XJ6 DIVERSION	09' - 16'	ASCENT	6326	(*)	(*)
XJ6 DIVERSION	09' - 16'	RADIKAL	6325	(*)	(*)
XJ6 DIVERSION	09' - 16'	RACING	5879	(*)	(*)
XJ6 DIVERSION	09' - 16'	BASIC	6404-6405-6406	(*)	
XJ6 DIVERSION F	10' - 16'	ASCENT	6326	(*)	(*)
XJ6 DIVERSION F	10' - 16'	RADIKAL	6325	(*)	(*)
XJ6 DIVERSION F	10' - 16'	RACING	5879	(*)	(*)
XJ6 DIVERSION F	10' - 16'	BASIC	6404-6405-6406	(*)	
XJR1200	94' - 98'	ASCENT	6326	(*)	(*)
XJR1200	94' - 98'	RADIKAL	6325	(*)	(*)
XJR1200	94' - 98'	RACING	5879	(*)	(*)
XJR1200	94' - 98'	BASIC	6404-6405-6406	(*)	
XJR1300	04' - 16'	ASCENT	6326	(*)	(*)
XJR1300	04' - 16'	RADIKAL	6325	(*)	(*)
XJR1300	04' - 16'	RACING	5879	(*)	(*)
XJR1300	04' - 16'	BASIC	6404-6405-6406	(*)	
XSR700	16' - 18'	ASCENT	6326	(*)	(*)
XSR700	16' - 18'	VINTAGE	9190	(*)	(*)
XSR700	16' - 18'	RADIKAL	6325	(*)	(*)
XSR700	16' - 18'	RACING	5879	(*)	(*)
XSR700	16' - 18'	BASIC	6404-6405-6406	(*)	
XSR900	16' - 18'	ASCENT	6326	(*)	(*)
XSR900	16' - 18'	VINTAGE	9190	(*)	(*)
XSR900	16' - 18'	RADIKAL	6325	(*)	(*)
XSR900	16' - 18'	RACING	5879	(*)	(*)
XSR900	16' - 18'	BASIC	6404-6405-6406	(*)	
XT660R	04' - 16'	ASCENT	6326	(*)	(*)
XT660R	04' - 16'	RADIKAL	6325	(*)	(*)
XT660R	04' - 16'	RACING	5879	(*)	(*)
XT660R	04' - 16'	BASIC	6404-6405-6406	(*)	
XT660X	04' - 16'	ASCENT	6326	(*)	(*)
XT660X	04' - 16'	RADIKAL	6325	(*)	(*)
XT660X	04' - 16'	RACING	5879	(*)	(*)
XT660X	04' - 16'	BASIC	6404-6405-6406	(*)	
XT660Z TÉNÉRÉ	08' - 16'	ASCENT	6326	(*)	(*)
XT660Z TÉNÉRÉ	08' - 16'	RADIKAL	6325	(*)	(*)
XT660Z TÉNÉRÉ	08' - 16'	RACING	5879	(*)	(*)
XT660Z TÉNÉRÉ	08' - 16'	BASIC	6404-6405-6406	(*)	
XT1200Z SUPER TÉNÉRÉ	10' - 18'	ASCENT	6326	(*)	(*)

MODEL	YEAR	TYPE OF GRIP	REF.	N	
XT1200Z SUPER TÉNÉRÉ	10' - 18'	RADIKAL	6325	(*)	(*)
XT1200Z SUPER TÉNÉRÉ	10' - 18'	RACING	5879	(*)	(*)
XT1200Z SUPER TÉNÉRÉ	10' - 18'	BASIC	6404-6405-6406	(*)	(*)
YZF-R125	14' - 18'	ASCENT	6326	(*)	(*)
YZF-R125	14' - 18'	RADIKAL	6325	(*)	(*)
YZF-R125	14' - 18'	RACING	5879	(*)	(*)
YZF-R125	14' - 18'	BASIC	6404-6405-6406	(*)	(*)
YZF-R1	99' - 18'	ASCENT	6326	(*)	(*)
YZF-R1	99' - 18'	RADIKAL	6325	(*)	(*)
YZF-R1	99' - 18'	RACING	5879	(*)	(*)
YZF-R1	99' - 18'	BASIC	6404-6405-6406	(*)	(*)
YZF-R3	15' - 18'	ASCENT	6326	(*)	(*)
YZF-R3	15' - 18'	RADIKAL	6325	(*)	(*)
YZF-R3	15' - 18'	RACING	5879	(*)	(*)
YZF-R3	15' - 18'	BASIC	6404-6405-6406	(*)	(*)
YZF-R6	99' - 18'	ASCENT	6326	(*)	(*)
YZF-R6	99' - 18'	RADIKAL	6325	(*)	(*)
YZF-R6	99' - 18'	RACING	5879	(*)	(*)
YZF-R6	99' - 18'	BASIC	6404-6405-6406	(*)	(*)

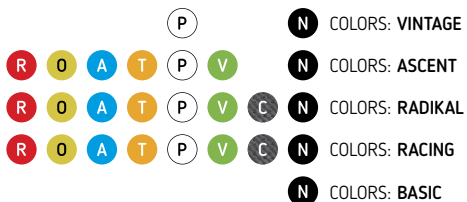

(*) Check price with your distributor.

IMPORTANT: Indicate code color after part#. Example: 0973A.

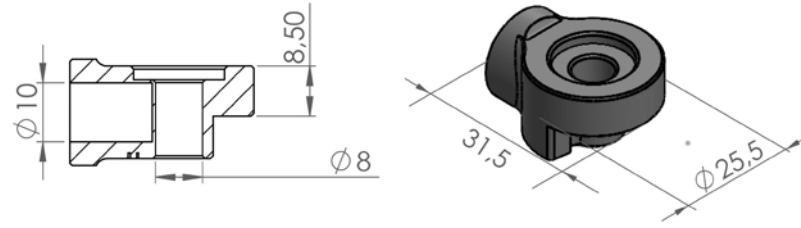

REF. 9532N-9533N

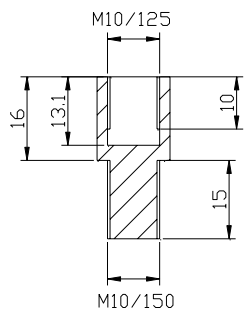

REF. 9585N

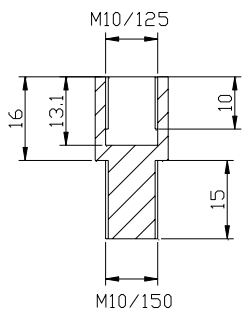

REF. 9271N

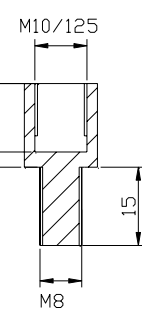
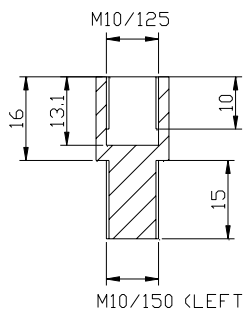

REF. 9578

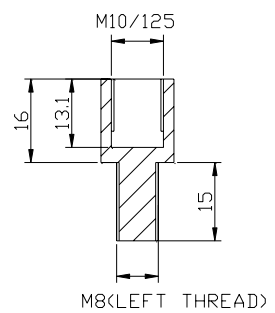

REF. 9279

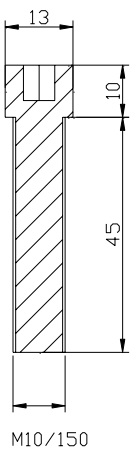

REF. 9984N

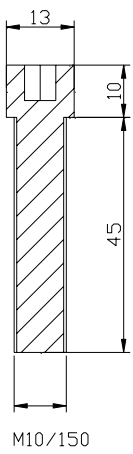

REF. 9983N

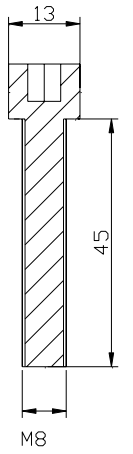
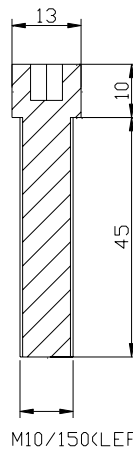

REF. 9982

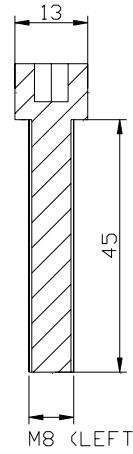

REF. 9981

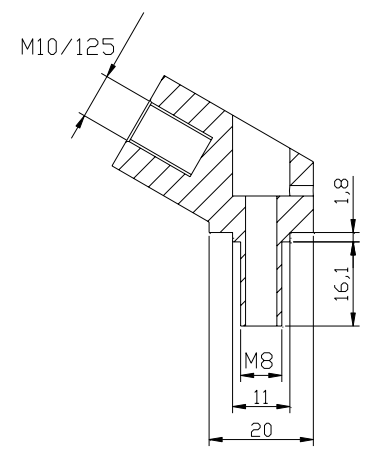

REF. 7517N

ADAPTORS TO HANDLEBAR REARVIEW MIRRORS

HI-TECH PARTS | TYPE OF REAR MIRROR:

2019
MODELS:
www.puig.tv

535

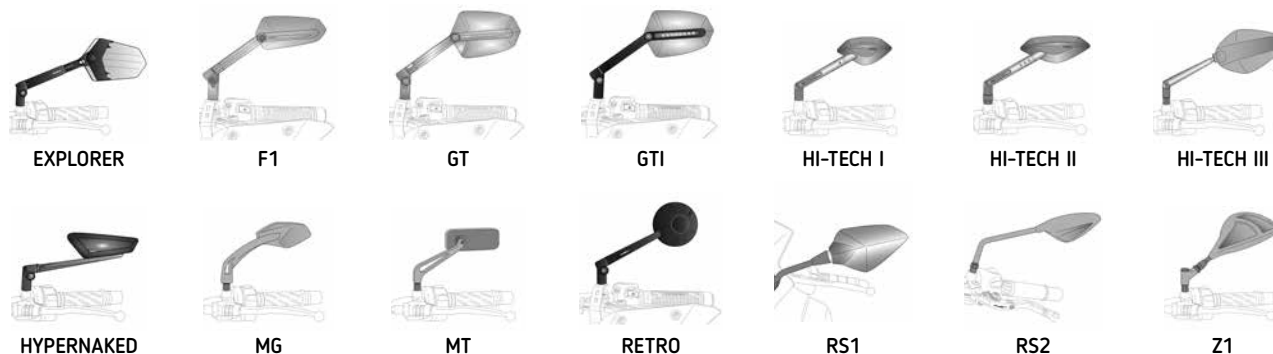

MODEL	YEAR	TYPE OF REAR MIRROR	SIDE	REF. ADAPTOR	N
BMW					
F650 GS	00' - 12'	HI-TECH I	RIGHT	9271N	(*)
F650 GS	00' - 12'	HI-TECH I	LEFT	9585N	(*)
F650 GS	00' - 12'	HI-TECH II	RIGHT	9271N	(*)
F650 GS	00' - 12'	HI-TECH II	LEFT	9585N	(*)
F650 GS	00' - 12'	HI-TECH III	RIGHT	9271N	(*)
F650 GS	00' - 12'	HI-TECH III	LEFT	9585N	(*)
F650 GS	00' - 12'	GT	RIGHT	9983N	(*)
F650 GS	00' - 12'	GT	LEFT	9984N	(*)
F650 GS	00' - 12'	F1	RIGHT	9983N	(*)
F650 GS	00' - 12'	F1	LEFT	9984N	(*)
F650 GS	00' - 12'	HYPERNAKED	RIGHT	9983N	(*)
F650 GS	00' - 12'	HYPERNAKED	LEFT	9984N	(*)
F650 GS	00' - 12'	EXPLORER	RIGHT	9983N	(*)
F650 GS	00' - 12'	EXPLORER	LEFT	9984N	(*)
F650 GS	00' - 12'	GTI	RIGHT	9983N	(*)
F650 GS	00' - 12'	GTI	LEFT	9984N	(*)
F650 GS	00' - 12'	RETRO	RIGHT	9983N	(*)
F650 GS	00' - 12'	RETRO	LEFT	9984N	(*)
F650 GS	00' - 12'	MT	RIGHT	9271N	(*)
F650 GS	00' - 12'	MT	LEFT	9585N	(*)
F650 GS	00' - 12'	MG	RIGHT	9271N	(*)
F650 GS	00' - 12'	MG	LEFT	9585N	(*)
F650 GS	00' - 12'	RS1	RIGHT	9271N	(*)
F650 GS	00' - 12'	RS1	LEFT	9585N	(*)
F650 GS	00' - 12'	RS2	RIGHT	9271N	(*)
F650 GS	00' - 12'	RS2	LEFT	9585N	(*)
F650 GS	00' - 12'	Z1	RIGHT	9271N	(*)
F650 GS	00' - 12'	Z1	LEFT	9585N	(*)



N
Black

(*) Check price with your distributor.

IMPORTANT: Indicate code color after part#. Example: 0973A.

ADAPTORS TO HANDLEBAR REARVIEW MIRRORS

HI-TECH PARTS | TYPE OF REAR MIRROR:

2019
MODELS:
www.puig.tv

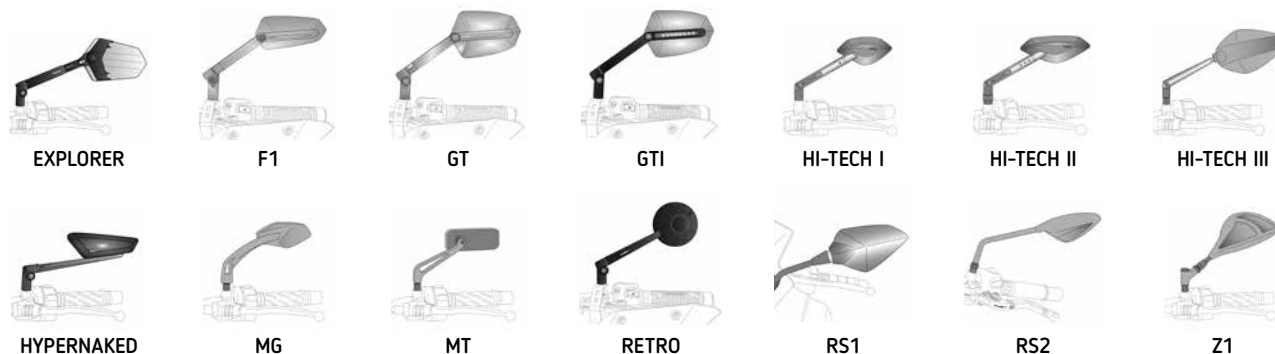

MODEL	YEAR	TYPE OF REAR MIRROR	SIDE	REF. ADAPTOR	N
F700GS	12' - 17'	HI-TECH I	RIGHT	9271N	(*)
F700GS	12' - 17'	HI-TECH I	LEFT	9585N	(*)
F700GS	12' - 17'	HI-TECH II	RIGHT	9271N	(*)
F700GS	12' - 17'	HI-TECH II	LEFT	9585N	(*)
F700GS	12' - 17'	HI-TECH III	RIGHT	9271N	(*)
F700GS	12' - 17'	HI-TECH III	LEFT	9585N	(*)
F700GS	12' - 17'	GT	RIGHT	9983N	(*)
F700GS	12' - 17'	GT	LEFT	9984N	(*)
F700GS	12' - 17'	F1	RIGHT	9983N	(*)
F700GS	12' - 17'	F1	LEFT	9984N	(*)
F700GS	12' - 17'	HYPERNAKED	RIGHT	9983N	(*)
F700GS	12' - 17'	HYPERNAKED	LEFT	9984N	(*)
F700GS	12' - 17'	EXPLORER	RIGHT	9983N	(*)
F700GS	12' - 17'	EXPLORER	LEFT	9984N	(*)
F700GS	12' - 17'	GTI	RIGHT	9983N	(*)
F700GS	12' - 17'	GTI	LEFT	9984N	(*)
F700GS	12' - 17'	RETRO	RIGHT	9983N	(*)
F700GS	12' - 17'	RETRO	LEFT	9984N	(*)
F700GS	12' - 17'	MT	RIGHT	9271N	(*)
F700GS	12' - 17'	MT	LEFT	9585N	(*)
F700GS	12' - 17'	MG	RIGHT	9271N	(*)
F700GS	12' - 17'	MG	LEFT	9585N	(*)
F700GS	12' - 17'	RS1	RIGHT	9271N	(*)
F700GS	12' - 17'	RS1	LEFT	9585N	(*)
F700GS	12' - 17'	RS2	RIGHT	9271N	(*)
F700GS	12' - 17'	RS2	LEFT	9585N	(*)
F700GS	12' - 17'	Z1	RIGHT	9271N	(*)
F700GS	12' - 17'	Z1	LEFT	9585N	(*)
F750 GS	18'	HI-TECH I	RIGHT	9271N	(*)
F750 GS	18'	HI-TECH I	LEFT	9585N	(*)
F750 GS	18'	HI-TECH II	RIGHT	9271N	(*)
F750 GS	18'	HI-TECH II	LEFT	9585N	(*)
F750 GS	18'	HI-TECH III	RIGHT	9271N	(*)
F750 GS	18'	HI-TECH III	LEFT	9585N	(*)
F750 GS	18'	GT	RIGHT	9983N	(*)

MODEL	YEAR	TYPE OF REAR MIRROR	SIDE	REF. ADAPTOR	N
F750 GS	18'	GT	LEFT	9984N	(*)
F750 GS	18'	F1	RIGHT	9983N	(*)
F750 GS	18'	F1	LEFT	9984N	(*)
F750 GS	18'	HYPERNAKED	RIGHT	9983N	(*)
F750 GS	18'	HYPERNAKED	LEFT	9984N	(*)
F750 GS	18'	EXPLORER	RIGHT	9983N	(*)
F750 GS	18'	EXPLORER	LEFT	9984N	(*)
F750 GS	18'	GTI	RIGHT	9983N	(*)
F750 GS	18'	GTI	LEFT	9984N	(*)
F750 GS	18'	RETRO	RIGHT	9983N	(*)
F750 GS	18'	RETRO	LEFT	9984N	(*)
F750 GS	18'	MT	RIGHT	9271N	(*)
F750 GS	18'	MT	LEFT	9585N	(*)
F750 GS	18'	MG	RIGHT	9271N	(*)
F750 GS	18'	MG	LEFT	9585N	(*)
F750 GS	18'	RS1	RIGHT	9271N	(*)
F750 GS	18'	RS1	LEFT	9585N	(*)
F750 GS	18'	RS2	RIGHT	9271N	(*)
F750 GS	18'	RS2	LEFT	9585N	(*)
F750 GS	18'	Z1	RIGHT	9271N	(*)
F750 GS	18'	Z1	LEFT	9585N	(*)
F800 GS	08' - 17'	HI-TECH I	RIGHT	9271N	(*)
F800 GS	08' - 17'	HI-TECH I	LEFT	9585N	(*)
F800 GS	08' - 17'	HI-TECH II	RIGHT	9271N	(*)
F800 GS	08' - 17'	HI-TECH II	LEFT	9585N	(*)
F800 GS	08' - 17'	HI-TECH III	RIGHT	9271N	(*)
F800 GS	08' - 17'	HI-TECH III	LEFT	9585N	(*)
F800 GS	08' - 17'	GT	RIGHT	9983N	(*)
F800 GS	08' - 17'	GT	LEFT	9984N	(*)
F800 GS	08' - 17'	F1	RIGHT	9983N	(*)
F800 GS	08' - 17'	F1	LEFT	9984N	(*)
F800 GS	08' - 17'	HYPERNAKED	RIGHT	9983N	(*)
F800 GS	08' - 17'	HYPERNAKED	LEFT	9984N	(*)
F800 GS	08' - 17'	EXPLORER	RIGHT	9983N	(*)
F800 GS	08' - 17'	EXPLORER	LEFT	9984N	(*)
F800 GS	08' - 17'	GTI	RIGHT	9983N	(*)
F800 GS	08' - 17'	GTI	LEFT	9984N	(*)
F800 GS	08' - 17'	RETRO	RIGHT	9983N	(*)
F800 GS	08' - 17'	RETRO	LEFT	9984N	(*)
F800 GS	08' - 17'	MT	RIGHT	9271N	(*)
F800 GS	08' - 17'	MT	LEFT	9585N	(*)
F800 GS	08' - 17'	MG	RIGHT	9271N	(*)
F800 GS	08' - 17'	MG	LEFT	9585N	(*)



N
Black

(*) Check price with your distributor.

IMPORTANT: Indicate code color after part#. Example: 0973A.

ADAPTORS TO HANDLEBAR REARVIEW MIRRORS

HI-TECH PARTS | TYPE OF REAR MIRROR:

2019
MODELS:
www.puig.tv



MODEL	YEAR	TYPE OF REAR MIRROR	SIDE	REF. ADAPTOR	N
F800 GS	08' - 17'	RS1	RIGHT	9271N	(*)
F800 GS	08' - 17'	RS1	LEFT	9585N	(*)
F800 GS	08' - 17'	RS2	RIGHT	9271N	(*)
F800 GS	08' - 17'	RS2	LEFT	9585N	(*)
F800 GS	08' - 17'	Z1	RIGHT	9271N	(*)
F800 GS	08' - 17'	Z1	LEFT	9585N	(*)
F850 GS	18'	HI-TECH I	RIGHT	9271N	(*)
F850 GS	18'	HI-TECH I	LEFT	9585N	(*)
F850 GS	18'	HI-TECH II	RIGHT	9271N	(*)
F850 GS	18'	HI-TECH II	LEFT	9585N	(*)
F850 GS	18'	HI-TECH III	RIGHT	9271N	(*)
F850 GS	18'	HI-TECH III	LEFT	9585N	(*)
F850 GS	18'	GT	RIGHT	9983N	(*)
F850 GS	18'	GT	LEFT	9984N	(*)
F850 GS	18'	F1	RIGHT	9983N	(*)
F850 GS	18'	F1	LEFT	9984N	(*)
F850 GS	18'	HYPERNAKED	RIGHT	9983N	(*)
F850 GS	18'	HYPERNAKED	LEFT	9984N	(*)
F850 GS	18'	EXPLORER	RIGHT	9983N	(*)
F850 GS	18'	EXPLORER	LEFT	9984N	(*)
F850 GS	18'	GTI	RIGHT	9983N	(*)
F850 GS	18'	GTI	LEFT	9984N	(*)
F850 GS	18'	RETRO	RIGHT	9983N	(*)
F850 GS	18'	RETRO	LEFT	9984N	(*)
F850 GS	18'	MT	RIGHT	9271N	(*)
F850 GS	18'	MT	LEFT	9585N	(*)
F850 GS	18'	MG	RIGHT	9271N	(*)
F850 GS	18'	MG	LEFT	9585N	(*)
F850 GS	18'	RS1	RIGHT	9271N	(*)
F850 GS	18'	RS1	LEFT	9585N	(*)
F850 GS	18'	RS2	RIGHT	9271N	(*)
F850 GS	18'	RS2	LEFT	9585N	(*)
F850 GS	18'	Z1	RIGHT	9271N	(*)
F850 GS	18'	Z1	LEFT	9585N	(*)
F800 R	09' - 18'	HI-TECH I	RIGHT	9271N	(*)

MODEL	YEAR	TYPE OF REAR MIRROR	SIDE	REF. ADAPTOR	N
F800 R	09' - 18'	HI-TECH I	LEFT	9585N	(*)
F800 R	09' - 18'	HI-TECH II	RIGHT	9271N	(*)
F800 R	09' - 18'	HI-TECH II	LEFT	9585N	(*)
F800 R	09' - 18'	HI-TECH III	RIGHT	9271N	(*)
F800 R	09' - 18'	HI-TECH III	LEFT	9585N	(*)
F800 R	09' - 18'	GT	RIGHT	9983N	(*)
F800 R	09' - 18'	GT	LEFT	9984N	(*)
F800 R	09' - 18'	F1	RIGHT	9983N	(*)
F800 R	09' - 18'	F1	LEFT	9984N	(*)
F800 R	09' - 18'	HYPERNAKED	RIGHT	9983N	(*)
F800 R	09' - 18'	HYPERNAKED	LEFT	9984N	(*)
F800 R	09' - 18'	EXPLORER	RIGHT	9983N	(*)
F800 R	09' - 18'	EXPLORER	LEFT	9984N	(*)
F800 R	09' - 18'	GTI	RIGHT	9983N	(*)
F800 R	09' - 18'	GTI	LEFT	9984N	(*)
F800 R	09' - 18'	RETRO	RIGHT	9983N	(*)
F800 R	09' - 18'	RETRO	LEFT	9984N	(*)
F800 R	09' - 18'	MT	RIGHT	9271N	(*)
F800 R	09' - 18'	MT	LEFT	9585N	(*)
F800 R	09' - 18'	MG	RIGHT	9271N	(*)
F800 R	09' - 18'	MG	LEFT	9585N	(*)
F800 R	09' - 18'	RS1	RIGHT	9271N	(*)
F800 R	09' - 18'	RS1	LEFT	9585N	(*)
F800 R	09' - 18'	RS2	RIGHT	9271N	(*)
F800 R	09' - 18'	RS2	LEFT	9585N	(*)
F800 R	09' - 18'	Z1	RIGHT	9271N	(*)
F800 R	09' - 18'	Z1	LEFT	9585N	(*)
G650 GS	11' - 16'	HI-TECH I	RIGHT	9271N	(*)
G650 GS	11' - 16'	HI-TECH I	LEFT	9585N	(*)
G650 GS	11' - 16'	HI-TECH II	RIGHT	9271N	(*)
G650 GS	11' - 16'	HI-TECH II	LEFT	9585N	(*)
G650 GS	11' - 16'	HI-TECH III	RIGHT	9271N	(*)
G650 GS	11' - 16'	HI-TECH III	LEFT	9585N	(*)
G650 GS	11' - 16'	GT	RIGHT	9983N	(*)
G650 GS	11' - 16'	GT	LEFT	9984N	(*)
G650 GS	11' - 16'	F1	RIGHT	9983N	(*)
G650 GS	11' - 16'	F1	LEFT	9984N	(*)
G650 GS	11' - 16'	HYPERNAKED	RIGHT	9983N	(*)
G650 GS	11' - 16'	HYPERNAKED	LEFT	9984N	(*)
G650 GS	11' - 16'	EXPLORER	RIGHT	9983N	(*)
G650 GS	11' - 16'	EXPLORER	LEFT	9984N	(*)
G650 GS	11' - 16'	GTI	RIGHT	9983N	(*)
G650 GS	11' - 16'	GTI	LEFT	9984N	(*)



N
Black

(*) Check price with your distributor.

IMPORTANT: Indicate code color after part#. Example: 0973A.

ADAPTORS TO HANDLEBAR REARVIEW MIRRORS

HI-TECH PARTS | TYPE OF REAR MIRROR:

2019
MODELS:
www.puig.tv

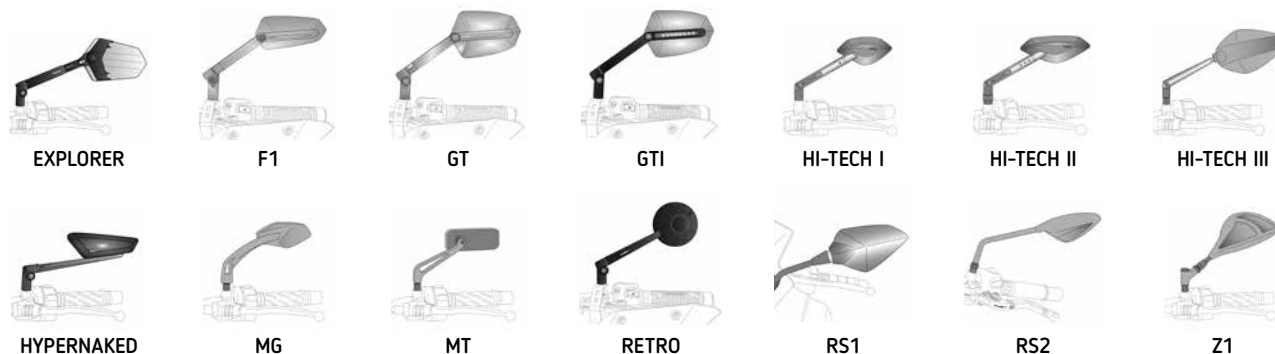

MODEL	YEAR	TYPE OF REAR MIRROR	SIDE	REF. ADAPTOR	N
G650 GS	11' - 16'	RETRO	RIGHT	9983N	(*)
G650 GS	11' - 16'	RETRO	LEFT	9984N	(*)
G650 GS	11' - 16'	MT	RIGHT	9271N	(*)
G650 GS	11' - 16'	MT	LEFT	9585N	(*)
G650 GS	11' - 16'	MG	RIGHT	9271N	(*)
G650 GS	11' - 16'	MG	LEFT	9585N	(*)
G650 GS	11' - 16'	RS1	RIGHT	9271N	(*)
G650 GS	11' - 16'	RS1	LEFT	9585N	(*)
G650 GS	11' - 16'	RS2	RIGHT	9271N	(*)
G650 GS	11' - 16'	RS2	LEFT	9585N	(*)
G650 GS	11' - 16'	Z1	RIGHT	9271N	(*)
G650 GS	11' - 16'	Z1	LEFT	9585N	(*)
K1300 R	09' - 16'	HI-TECH I	RIGHT	9271N	(*)
K1300 R	09' - 16'	HI-TECH I	LEFT	9585N	(*)
K1300 R	09' - 16'	HI-TECH II	RIGHT	9271N	(*)
K1300 R	09' - 16'	HI-TECH II	LEFT	9585N	(*)
K1300 R	09' - 16'	HI-TECH III	RIGHT	9271N	(*)
K1300 R	09' - 16'	HI-TECH III	LEFT	9585N	(*)
K1300 R	09' - 16'	GT	RIGHT	9983N	(*)
K1300 R	09' - 16'	GT	LEFT	9984N	(*)
K1300 R	09' - 16'	F1	RIGHT	9983N	(*)
K1300 R	09' - 16'	F1	LEFT	9984N	(*)
K1300 R	09' - 16'	HYPERNAKED	RIGHT	9983N	(*)
K1300 R	09' - 16'	HYPERNAKED	LEFT	9984N	(*)
K1300 R	09' - 16'	EXPLORER	RIGHT	9983N	(*)
K1300 R	09' - 16'	EXPLORER	LEFT	9984N	(*)
K1300 R	09' - 16'	GTI	RIGHT	9983N	(*)
K1300 R	09' - 16'	GTI	LEFT	9984N	(*)
K1300 R	09' - 16'	RETRO	RIGHT	9983N	(*)
K1300 R	09' - 16'	RETRO	LEFT	9984N	(*)
K1300 R	09' - 16'	MT	RIGHT	9271N	(*)
K1300 R	09' - 16'	MT	LEFT	9585N	(*)
K1300 R	09' - 16'	MG	RIGHT	9271N	(*)
K1300 R	09' - 16'	MG	LEFT	9585N	(*)
K1300 R	09' - 16'	RS1	RIGHT	9271N	(*)

MODEL	YEAR	TYPE OF REAR MIRROR	SIDE	REF. ADAPTOR	N
K1300 R	09' - 16'	RS1	LEFT	9585N	(*)
K1300 R	09' - 16'	RS2	RIGHT	9271N	(*)
K1300 R	09' - 16'	RS2	LEFT	9585N	(*)
K1300 R	09' - 16'	Z1	RIGHT	9271N	(*)
K1300 R	09' - 16'	Z1	LEFT	9585N	(*)
R1200 GS	04' - 18'	HI-TECH I	RIGHT	9271N	(*)
R1200 GS	04' - 18'	HI-TECH I	LEFT	9585N	(*)
R1200 GS	04' - 18'	HI-TECH II	RIGHT	9271N	(*)
R1200 GS	04' - 18'	HI-TECH II	LEFT	9585N	(*)
R1200 GS	04' - 18'	HI-TECH III	RIGHT	9271N	(*)
R1200 GS	04' - 18'	HI-TECH III	LEFT	9585N	(*)
R1200 GS	04' - 18'	GT	RIGHT	9983N	(*)
R1200 GS	04' - 18'	GT	LEFT	9984N	(*)
R1200 GS	04' - 18'	F1	RIGHT	9983N	(*)
R1200 GS	04' - 18'	F1	LEFT	9984N	(*)
R1200 GS	04' - 18'	HYPERNAKED	RIGHT	9983N	(*)
R1200 GS	04' - 18'	HYPERNAKED	LEFT	9984N	(*)
R1200 GS	04' - 18'	EXPLORER	RIGHT	9983N	(*)
R1200 GS	04' - 18'	EXPLORER	LEFT	9984N	(*)
R1200 GS	04' - 18'	GTI	RIGHT	9983N	(*)
R1200 GS	04' - 18'	GTI	LEFT	9984N	(*)
R1200 GS	04' - 18'	RETRO	RIGHT	9983N	(*)
R1200 GS	04' - 18'	RETRO	LEFT	9984N	(*)
R1200 GS	04' - 18'	MT	RIGHT	9271N	(*)
R1200 GS	04' - 18'	MT	LEFT	9585N	(*)
R1200 GS	04' - 18'	MG	RIGHT	9271N	(*)
R1200 GS	04' - 18'	MG	LEFT	9585N	(*)
R1200 GS	04' - 18'	RS1	RIGHT	9271N	(*)
R1200 GS	04' - 18'	RS1	LEFT	9585N	(*)
R1200 GS	04' - 18'	RS2	RIGHT	9271N	(*)
R1200 GS	04' - 18'	RS2	LEFT	9585N	(*)
R1200 GS	04' - 18'	Z1	RIGHT	9271N	(*)
R1200 GS	04' - 18'	Z1	LEFT	9585N	(*)
R1200GS EXCLUSIVE	17' - 18'	HI-TECH I	RIGHT	9271N	(*)
R1200GS EXCLUSIVE	17' - 18'	HI-TECH I	LEFT	9585N	(*)
R1200GS EXCLUSIVE	17' - 18'	HI-TECH II	RIGHT	9271N	(*)
R1200GS EXCLUSIVE	17' - 18'	HI-TECH II	LEFT	9585N	(*)
R1200GS EXCLUSIVE	17' - 18'	HI-TECH III	RIGHT	9271N	(*)
R1200GS EXCLUSIVE	17' - 18'	HI-TECH III	LEFT	9585N	(*)
R1200GS EXCLUSIVE	17' - 18'	GT	RIGHT	9983N	(*)
R1200GS EXCLUSIVE	17' - 18'	GT	LEFT	9984N	(*)
R1200GS EXCLUSIVE	17' - 18'	F1	RIGHT	9983N	(*)
R1200GS EXCLUSIVE	17' - 18'	F1	LEFT	9984N	(*)



N
Black

(*) Check price with your distributor.

IMPORTANT: Indicate code color after part#. Example: 0973A.

ADAPTORS TO HANDLEBAR REARVIEW MIRRORS

HI-TECH PARTS | TYPE OF REAR MIRROR:

2019
MODELS:
www.puig.tv



MODEL	YEAR	TYPE OF REAR MIRROR	SIDE	REF. ADAPTOR	N
R1200GS EXCLUSIVE	17' - 18'	HYPERNAILED	RIGHT	9983N	(*)
R1200GS EXCLUSIVE	17' - 18'	HYPERNAILED	LEFT	9984N	(*)
R1200GS EXCLUSIVE	17' - 18'	EXPLORER	RIGHT	9983N	(*)
R1200GS EXCLUSIVE	17' - 18'	EXPLORER	LEFT	9984N	(*)
R1200GS EXCLUSIVE	17' - 18'	GTI	RIGHT	9983N	(*)
R1200GS EXCLUSIVE	17' - 18'	GTI	LEFT	9984N	(*)
R1200GS EXCLUSIVE	17' - 18'	RETRO	RIGHT	9983N	(*)
R1200GS EXCLUSIVE	17' - 18'	RETRO	LEFT	9984N	(*)
R1200GS EXCLUSIVE	17' - 18'	MT	RIGHT	9271N	(*)
R1200GS EXCLUSIVE	17' - 18'	MT	LEFT	9585N	(*)
R1200GS EXCLUSIVE	17' - 18'	MG	RIGHT	9271N	(*)
R1200GS EXCLUSIVE	17' - 18'	MG	LEFT	9585N	(*)
R1200GS EXCLUSIVE	17' - 18'	RS1	RIGHT	9271N	(*)
R1200GS EXCLUSIVE	17' - 18'	RS1	LEFT	9585N	(*)
R1200GS EXCLUSIVE	17' - 18'	RS2	RIGHT	9271N	(*)
R1200GS EXCLUSIVE	17' - 18'	RS2	LEFT	9585N	(*)
R1200GS EXCLUSIVE	17' - 18'	Z1	RIGHT	9271N	(*)
R1200GS EXCLUSIVE	17' - 18'	Z1	LEFT	9585N	(*)
R1200GS RALLYE	17' - 18'	HI-TECH I	RIGHT	9271N	(*)
R1200GS RALLYE	17' - 18'	HI-TECH I	LEFT	9585N	(*)
R1200GS RALLYE	17' - 18'	HI-TECH II	RIGHT	9271N	(*)
R1200GS RALLYE	17' - 18'	HI-TECH II	LEFT	9585N	(*)
R1200GS RALLYE	17' - 18'	HI-TECH III	RIGHT	9271N	(*)
R1200GS RALLYE	17' - 18'	HI-TECH III	LEFT	9585N	(*)
R1200GS RALLYE	17' - 18'	GT	RIGHT	9983N	(*)
R1200GS RALLYE	17' - 18'	GT	LEFT	9984N	(*)
R1200GS RALLYE	17' - 18'	F1	RIGHT	9983N	(*)
R1200GS RALLYE	17' - 18'	F1	LEFT	9984N	(*)
R1200GS RALLYE	17' - 18'	HYPERNAILED	RIGHT	9983N	(*)
R1200GS RALLYE	17' - 18'	HYPERNAILED	LEFT	9984N	(*)
R1200GS RALLYE	17' - 18'	EXPLORER	RIGHT	9983N	(*)
R1200GS RALLYE	17' - 18'	EXPLORER	LEFT	9984N	(*)
R1200GS RALLYE	17' - 18'	GTI	RIGHT	9983N	(*)
R1200GS RALLYE	17' - 18'	GTI	LEFT	9984N	(*)
R1200GS RALLYE	17' - 18'	RETRO	RIGHT	9983N	(*)

MODEL	YEAR	TYPE OF REAR MIRROR	SIDE	REF. ADAPTOR	N
R1200GS RALLYE	17' - 18'	RETRO	LEFT	9984N	(*)
R1200GS RALLYE	17' - 18'	MT	RIGHT	9271N	(*)
R1200GS RALLYE	17' - 18'	MT	LEFT	9585N	(*)
R1200GS RALLYE	17' - 18'	MG	RIGHT	9271N	(*)
R1200GS RALLYE	17' - 18'	MG	LEFT	9585N	(*)
R1200GS RALLYE	17' - 18'	RS1	RIGHT	9271N	(*)
R1200GS RALLYE	17' - 18'	RS1	LEFT	9585N	(*)
R1200GS RALLYE	17' - 18'	RS2	RIGHT	9271N	(*)
R1200GS RALLYE	17' - 18'	RS2	LEFT	9585N	(*)
R1200GS RALLYE	17' - 18'	Z1	RIGHT	9271N	(*)
R1200GS RALLYE	17' - 18'	Z1	LEFT	9585N	(*)
R1200GS ADVENTURE	14' - 18'	HI-TECH I	RIGHT	9271N	(*)
R1200GS ADVENTURE	14' - 18'	HI-TECH I	LEFT	9585N	(*)
R1200GS ADVENTURE	14' - 18'	HI-TECH II	RIGHT	9271N	(*)
R1200GS ADVENTURE	14' - 18'	HI-TECH II	LEFT	9585N	(*)
R1200GS ADVENTURE	14' - 18'	HI-TECH III	RIGHT	9271N	(*)
R1200GS ADVENTURE	14' - 18'	HI-TECH III	LEFT	9585N	(*)
R1200GS ADVENTURE	14' - 18'	GT	RIGHT	9983N	(*)
R1200GS ADVENTURE	14' - 18'	GT	LEFT	9984N	(*)
R1200GS ADVENTURE	14' - 18'	F1	RIGHT	9983N	(*)
R1200GS ADVENTURE	14' - 18'	F1	LEFT	9984N	(*)
R1200GS ADVENTURE	14' - 18'	HYPERNAKED	RIGHT	9983N	(*)
R1200GS ADVENTURE	14' - 18'	HYPERNAKED	LEFT	9984N	(*)
R1200GS ADVENTURE	14' - 18'	EXPLORER	RIGHT	9983N	(*)
R1200GS ADVENTURE	14' - 18'	EXPLORER	LEFT	9984N	(*)
R1200GS ADVENTURE	14' - 18'	GTI	RIGHT	9983N	(*)
R1200GS ADVENTURE	14' - 18'	GTI	LEFT	9984N	(*)
R1200GS ADVENTURE	14' - 18'	RETRO	RIGHT	9983N	(*)
R1200GS ADVENTURE	14' - 18'	RETRO	LEFT	9984N	(*)
R1200GS ADVENTURE	14' - 18'	MT	RIGHT	9271N	(*)
R1200GS ADVENTURE	14' - 18'	MT	LEFT	9585N	(*)
R1200GS ADVENTURE	14' - 18'	MG	RIGHT	9271N	(*)
R1200GS ADVENTURE	14' - 18'	MG	RIGHT	9271N	(*)
R1200GS ADVENTURE	14' - 18'	RS1	RIGHT	9271N	(*)
R1200GS ADVENTURE	14' - 18'	RS1	LEFT	9585N	(*)
R1200GS ADVENTURE	14' - 18'	RS2	RIGHT	9271N	(*)
R1200GS ADVENTURE	14' - 18'	RS2	LEFT	9585N	(*)
R1200GS ADVENTURE	14' - 18'	Z1	RIGHT	9271N	(*)
R1200GS ADVENTURE	14' - 18'	Z1	LEFT	9585N	(*)
R1250GS	18'	HI-TECH I	RIGHT	9271N	(*)
R1250GS	18'	HI-TECH I	LEFT	9585N	(*)
R1250GS	18'	HI-TECH II	RIGHT	9271N	(*)
R1250GS	18'	HI-TECH II	LEFT	9585N	(*)



N
Black

(*) Check price with your distributor.

IMPORTANT: Indicate code color after part#. Example: 0973A.

ADAPTORS TO HANDLEBAR REARVIEW MIRRORS

HI-TECH PARTS | TYPE OF REAR MIRROR:

2019
MODELS:
www.puig.tv

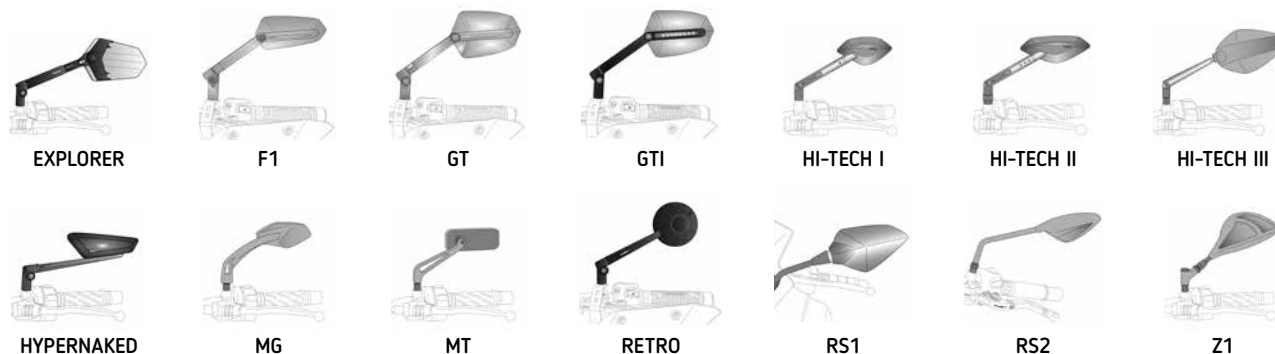

MODEL	YEAR	TYPE OF REAR MIRROR	SIDE	REF. ADAPTOR	N
R1250GS	18'	HI-TECH III	RIGHT	9271N	(*)
R1250GS	18'	HI-TECH III	LEFT	9585N	(*)
R1250GS	18'	GT	RIGHT	9983N	(*)
R1250GS	18'	GT	LEFT	9984N	(*)
R1250GS	18'	F1	RIGHT	9983N	(*)
R1250GS	18'	F1	LEFT	9984N	(*)
R1250GS	18'	HYPERNAKED	RIGHT	9983N	(*)
R1250GS	18'	HYPERNAKED	LEFT	9984N	(*)
R1250GS	18'	EXPLORER	RIGHT	9983N	(*)
R1250GS	18'	EXPLORER	LEFT	9984N	(*)
R1250GS	18'	GTI	RIGHT	9983N	(*)
R1250GS	18'	GTI	LEFT	9984N	(*)
R1250GS	18'	RETRO	RIGHT	9983N	(*)
R1250GS	18'	RETRO	LEFT	9984N	(*)
R1250GS	18'	MT	RIGHT	9271N	(*)
R1250GS	18'	MT	LEFT	9585N	(*)
R1250GS	18'	MG	RIGHT	9271N	(*)
R1250GS	18'	MG	RIGHT	9271N	(*)
R1250GS	18'	RS1	RIGHT	9271N	(*)
R1250GS	18'	RS1	LEFT	9585N	(*)
R1250GS	18'	RS2	RIGHT	9271N	(*)
R1250GS	18'	RS2	LEFT	9585N	(*)
R1250GS	18'	Z1	RIGHT	9271N	(*)
R1250GS	18'	Z1	LEFT	9585N	(*)
R1200 R	15' - 18'	HI-TECH I	RIGHT	9271N	(*)
R1200 R	15' - 18'	HI-TECH I	LEFT	9585N	(*)
R1200 R	15' - 18'	HI-TECH II	RIGHT	9271N	(*)
R1200 R	15' - 18'	HI-TECH II	LEFT	9585N	(*)
R1200 R	15' - 18'	HI-TECH III	RIGHT	9271N	(*)
R1200 R	15' - 18'	HI-TECH III	LEFT	9585N	(*)
R1200 R	15' - 18'	GT	RIGHT	9983N	(*)
R1200 R	15' - 18'	GT	LEFT	9984N	(*)
R1200 R	15' - 18'	F1	RIGHT	9983N	(*)
R1200 R	15' - 18'	F1	LEFT	9984N	(*)
R1200 R	15' - 18'	HYPERNAKED	RIGHT	9983N	(*)

MODEL	YEAR	TYPE OF REAR MIRROR	SIDE	REF. ADAPTOR	N
R1200 R	15' - 18'	HYPERNAKED	LEFT	9984N	(*)
R1200 R	15' - 18'	EXPLORER	RIGHT	9983N	(*)
R1200 R	15' - 18'	EXPLORER	LEFT	9984N	(*)
R1200 R	15' - 18'	GTI	RIGHT	9983N	(*)
R1200 R	15' - 18'	GTI	LEFT	9984N	(*)
R1200 R	15' - 18'	RETRO	RIGHT	9983N	(*)
R1200 R	15' - 18'	RETRO	LEFT	9984N	(*)
R1200 R	15' - 18'	MT	RIGHT	9271N	(*)
R1200 R	15' - 18'	MT	LEFT	9585N	(*)
R1200 R	15' - 18'	MG	RIGHT	9271N	(*)
R1200 R	15' - 18'	MG	LEFT	9585N	(*)
R1200 R	15' - 18'	RS1	RIGHT	9271N	(*)
R1200 R	15' - 18'	RS1	LEFT	9585N	(*)
R1200 R	15' - 18'	RS2	RIGHT	9271N	(*)
R1200 R	15' - 18'	RS2	LEFT	9585N	(*)
R1200 R	15' - 18'	Z1	RIGHT	9271N	(*)
R1200 R	15' - 18'	Z1	LEFT	9585N	(*)
R NINE T/SCRAMBLER/PURE/URBAN G/S		HI-TECH I	RIGHT	9271N	(*)
R NINE T/SCRAMBLER/PURE/URBAN G/S		HI-TECH I	LEFT	9585N	(*)
R NINE T/SCRAMBLER/PURE/URBAN G/S		HI-TECH II	RIGHT	9271N	(*)
R NINE T/SCRAMBLER/PURE/URBAN G/S		HI-TECH II	LEFT	9585N	(*)
R NINE T/SCRAMBLER/PURE/URBAN G/S		HI-TECH III	RIGHT	9271N	(*)
R NINE T/SCRAMBLER/PURE/URBAN G/S		HI-TECH III	LEFT	9585N	(*)
R NINE T/SCRAMBLER/PURE/URBAN G/S		GT	RIGHT	9983N	(*)
R NINE T/SCRAMBLER/PURE/URBAN G/S		GT	LEFT	9984N	(*)
R NINE T/SCRAMBLER/PURE/URBAN G/S		F1	RIGHT	9983N	(*)
R NINE T/SCRAMBLER/PURE/URBAN G/S		F1	LEFT	9984N	(*)
R NINE T/SCRAMBLER/PURE/URBAN G/S		HYPERNAKED	RIGHT	9983N	(*)
R NINE T/SCRAMBLER/PURE/URBAN G/S		HYPERNAKED	LEFT	9984N	(*)
R NINE T/SCRAMBLER/PURE/URBAN G/S		EXPLORER	RIGHT	9983N	(*)
R NINE T/SCRAMBLER/PURE/URBAN G/S		EXPLORER	LEFT	9984N	(*)
R NINE T/SCRAMBLER/PURE/URBAN G/S		GTI	RIGHT	9983N	(*)
R NINE T/SCRAMBLER/PURE/URBAN G/S		GTI	LEFT	9984N	(*)
R NINE T/SCRAMBLER/PURE/URBAN G/S		RETRO	RIGHT	9983N	(*)
R NINE T/SCRAMBLER/PURE/URBAN G/S		RETRO	LEFT	9984N	(*)
R NINE T/SCRAMBLER/PURE/URBAN G/S		MT	RIGHT	9271N	(*)
R NINE T/SCRAMBLER/PURE/URBAN G/S		MT	LEFT	9585N	(*)
R NINE T/SCRAMBLER/PURE/URBAN G/S		MG	RIGHT	9271N	(*)
R NINE T/SCRAMBLER/PURE/URBAN G/S		MG	LEFT	9585N	(*)
R NINE T/SCRAMBLER/PURE/URBAN G/S		RS1	RIGHT	9271N	(*)
R NINE T/SCRAMBLER/PURE/URBAN G/S		RS1	LEFT	9585N	(*)
R NINE T/SCRAMBLER/PURE/URBAN G/S		RS2	RIGHT	9271N	(*)
R NINE T/SCRAMBLER/PURE/URBAN G/S		RS2	LEFT	9585N	(*)



N
Black

(*) Check price with your distributor.

IMPORTANT: Indicate code color after part#. Example: 0973A.

ADAPTORS TO HANDLEBAR REARVIEW MIRRORS

HI-TECH PARTS | TYPE OF REAR MIRROR:

2019
MODELS:
www.puig.tv



MODEL	YEAR	TYPE OF REAR MIRROR	SIDE	REF. ADAPTOR	N
R NINE T/SCRAMBLER/PURE/URBAN G/S		Z1	RIGHT	9271N	(*)
R NINE T/SCRAMBLER/PURE/URBAN G/S		Z1	LEFT	9585N	(*)
R NINE T RACER	17' -18'	HI-TECH I	RIGHT	9532N	(*)
R NINE T RACER	17' -18'	HI-TECH I	LEFT	9533N	(*)
R NINE T RACER	17' -18'	HI-TECH II	RIGHT	9532N	(*)
R NINE T RACER	17' -18'	HI-TECH II	LEFT	9533N	(*)
R NINE T RACER	17' -18'	HI-TECH III	RIGHT	9532N	(*)
R NINE T RACER	17' -18'	HI-TECH III	LEFT	9533N	(*)
R NINE T RACER	17' -18'	GT	RIGHT	9532N	(*)
R NINE T RACER	17' -18'	GT	LEFT	9533N	(*)
R NINE T RACER	17' -18'	F1	RIGHT	9532N	(*)
R NINE T RACER	17' -18'	F1	LEFT	9533N	(*)
R NINE T RACER	17' -18'	HYPERNAKED	RIGHT	9532N	(*)
R NINE T RACER	17' -18'	HYPERNAKED	LEFT	9533N	(*)
R NINE T RACER	17' -18'	EXPLORER	RIGHT	9532N	(*)
R NINE T RACER	17' -18'	EXPLORER	LEFT	9533N	(*)
R NINE T RACER	17' -18'	GTI	RIGHT	9532N	(*)
R NINE T RACER	17' -18'	GTI	LEFT	9533N	(*)
R NINE T RACER	17' -18'	RETRO	RIGHT	9532N	(*)
R NINE T RACER	17' -18'	RETRO	LEFT	9533N	(*)
R NINE T RACER	17' -18'	MT	RIGHT	9532N	(*)
R NINE T RACER	17' -18'	MT	LEFT	9533N	(*)
R NINE T RACER	17' -18'	MG	RIGHT	9532N	(*)
R NINE T RACER	17' -18'	MG	LEFT	9533N	(*)
R NINE T RACER	17' -18'	RS1	RIGHT	9271N	(*)
R NINE T RACER	17' -18'	RS1	LEFT	9585N	(*)
R NINE T RACER	17' -18'	RS2	RIGHT	9271N	(*)
R NINE T RACER	17' -18'	RS2	LEFT	9585N	(*)
R NINE T RACER	17' -18'	Z1	RIGHT	9271N	(*)
R NINE T RACER	17' -18'	Z1	LEFT	9585N	(*)
S1000 R	14' -18'	HI-TECH I	RIGHT	9271N	(*)
S1000 R	14' -18'	HI-TECH I	LEFT	9585N	(*)
S1000 R	14' -18'	HI-TECH II	RIGHT	9271N	(*)
S1000 R	14' -18'	HI-TECH II	LEFT	9585N	(*)
S1000 R	14' -18'	HI-TECH III	RIGHT	9271N	(*)

MODEL	YEAR	TYPE OF REAR MIRROR	SIDE	REF. ADAPTOR	N
S1000 R	14' - 18'	HI-TECH III	LEFT	9585N	(*)
S1000 R	14' - 18'	GT	RIGHT	9983N	(*)
S1000 R	14' - 18'	GT	LEFT	9984N	(*)
S1000 R	14' - 18'	F1	RIGHT	9983N	(*)
S1000 R	14' - 18'	F1	LEFT	9984N	(*)
S1000 R	14' - 18'	HYPERNAKED	RIGHT	9983N	(*)
S1000 R	14' - 18'	HYPERNAKED	LEFT	9984N	(*)
S1000 R	14' - 18'	EXPLORER	RIGHT	9983N	(*)
S1000 R	14' - 18'	EXPLORER	LEFT	9984N	(*)
S1000 R	14' - 18'	GTI	RIGHT	9983N	(*)
S1000 R	14' - 18'	GTI	LEFT	9984N	(*)
S1000 R	14' - 18'	RETRO	RIGHT	9983N	(*)
S1000 R	14' - 18'	RETRO	LEFT	9984N	(*)
S1000 R	14' - 18'	MT	RIGHT	9271N	(*)
S1000 R	14' - 18'	MT	LEFT	9585N	(*)
S1000 R	14' - 18'	MG	RIGHT	9271N	(*)
S1000 R	14' - 18'	MG	LEFT	9585N	(*)
S1000 R	14' - 18'	RS1	RIGHT	9271N	(*)
S1000 R	14' - 18'	RS1	LEFT	9585N	(*)
S1000 R	14' - 18'	RS2	RIGHT	9271N	(*)
S1000 R	14' - 18'	RS2	LEFT	9585N	(*)
S1000 R	14' - 18'	Z1	RIGHT	9271N	(*)
S1000 R	14' - 18'	Z1	LEFT	9585N	(*)
S1000 XR	15' - 18'	HI-TECH I	RIGHT	9271N	(*)
S1000 XR	15' - 18'	HI-TECH I	LEFT	9585N	(*)
S1000 XR	15' - 18'	HI-TECH II	RIGHT	9271N	(*)
S1000 XR	15' - 18'	HI-TECH II	LEFT	9585N	(*)
S1000 XR	15' - 18'	HI-TECH III	RIGHT	9271N	(*)
S1000 XR	15' - 18'	HI-TECH III	LEFT	9585N	(*)
S1000 XR	15' - 18'	GT	RIGHT	9983N	(*)
S1000 XR	15' - 18'	GT	LEFT	9984N	(*)
S1000 XR	15' - 18'	F1	RIGHT	9983N	(*)
S1000 XR	15' - 18'	F1	LEFT	9984N	(*)
S1000 XR	15' - 18'	HYPERNAKED	RIGHT	9983N	(*)
S1000 XR	15' - 18'	HYPERNAKED	LEFT	9984N	(*)
S1000 XR	15' - 18'	EXPLORER	RIGHT	9983N	(*)
S1000 XR	15' - 18'	EXPLORER	LEFT	9984N	(*)
S1000 XR	15' - 18'	GTI	RIGHT	9983N	(*)
S1000 XR	15' - 18'	GTI	LEFT	9984N	(*)
S1000 XR	15' - 18'	RETRO	RIGHT	9983N	(*)
S1000 XR	15' - 18'	RETRO	LEFT	9984N	(*)
S1000 XR	15' - 18'	MT	RIGHT	9271N	(*)
S1000 XR	15' - 18'	MT	LEFT	9585N	(*)



N
Black

(*) Check price with your distributor.

IMPORTANT: Indicate code color after part#. Example: 0973A.

ADAPTORS TO HANDLEBAR REARVIEW MIRRORS

HI-TECH PARTS | TYPE OF REAR MIRROR:

2019
MODELS:
www.puig.tv

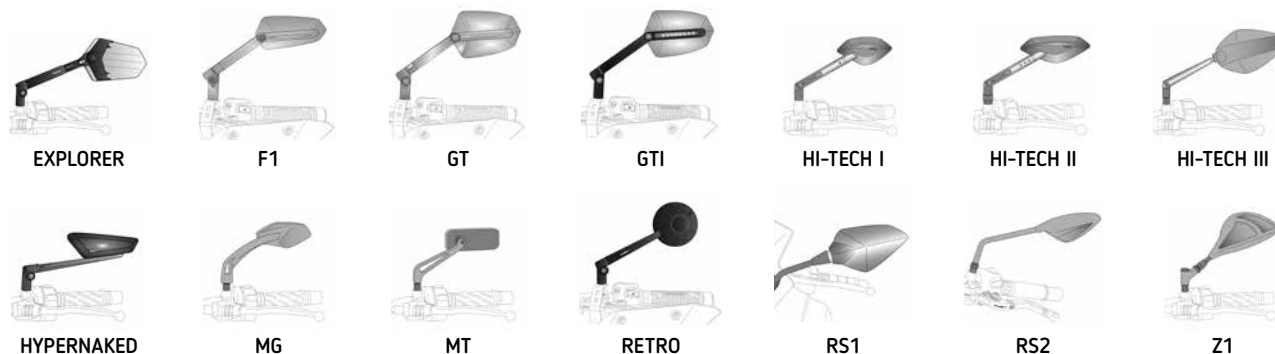

MODEL	YEAR	TYPE OF REAR MIRROR	SIDE	REF. ADAPTOR	N
S1000 XR	15' - 18'	MG	RIGHT	9271N	(*)
S1000 XR	15' - 18'	MG	LEFT	9585N	(*)
S1000 XR	15' - 18'	RS1	RIGHT	9271N	(*)
S1000 XR	15' - 18'	RS1	LEFT	9585N	(*)
S1000 XR	15' - 18'	RS2	RIGHT	9271N	(*)
S1000 XR	15' - 18'	RS2	LEFT	9585N	(*)
S1000 XR	15' - 18'	Z1	RIGHT	9271N	(*)
S1000 XR	15' - 18'	Z1	LEFT	9585N	(*)
DUCATI					
X DIAVEL	16' - 18'	HI-TECH I	RIGHT	9579N	(*)
X DIAVEL	16' - 18'	HI-TECH I	LEFT	9578N	(*)
X DIAVEL	16' - 18'	HI-TECH II	RIGHT	9579N	(*)
X DIAVEL	16' - 18'	HI-TECH II	LEFT	9578N	(*)
X DIAVEL	16' - 18'	HI-TECH III	RIGHT	9579N	(*)
X DIAVEL	16' - 18'	HI-TECH III	LEFT	9578N	(*)
X DIAVEL	16' - 18'	GT	RIGHT	9981N	(*)
X DIAVEL	16' - 18'	GT	LEFT	9982N	(*)
X DIAVEL	16' - 18'	F1	RIGHT	9981N	(*)
X DIAVEL	16' - 18'	F1	LEFT	9982N	(*)
X DIAVEL	16' - 18'	HYPERNAKED	RIGHT	9981N	(*)
X DIAVEL	16' - 18'	HYPERNAKED	LEFT	9982N	(*)
X DIAVEL	16' - 18'	EXPLORER	RIGHT	9981N	(*)
X DIAVEL	16' - 18'	EXPLORER	LEFT	9982N	(*)
X DIAVEL	16' - 18'	GTI	RIGHT	9981N	(*)
X DIAVEL	16' - 18'	GTI	LEFT	9982N	(*)
X DIAVEL	16' - 18'	RETRO	RIGHT	9981N	(*)
X DIAVEL	16' - 18'	RETRO	LEFT	9982N	(*)
X DIAVEL	16' - 18'	MT	RIGHT	9579N	(*)
X DIAVEL	16' - 18'	MT	LEFT	9578N	(*)
X DIAVEL	16' - 18'	MG	RIGHT	9579N	(*)
X DIAVEL	16' - 18'	MG	LEFT	9578N	(*)
X DIAVEL	16' - 18'	RS1	RIGHT	9579N	(*)
X DIAVEL	16' - 18'	RS1	LEFT	9578N	(*)
X DIAVEL	16' - 18'	RS2	RIGHT	9579N	(*)
X DIAVEL	16' - 18'	RS2	LEFT	9578N	(*)

MODEL	YEAR	TYPE OF REAR MIRROR	SIDE	REF. ADAPTOR	N
X DIAVEL	16' - 18'	Z1	RIGHT	9579N	(*)
X DIAVEL	16' - 18'	Z1	LEFT	9578N	(*)
STREETFIGHTER 848	12' - 16'	HI-TECH I	RIGHT	9579N	(*)
STREETFIGHTER 848	12' - 16'	HI-TECH I	LEFT	9578N	(*)
STREETFIGHTER 848	12' - 16'	HI-TECH II	RIGHT	9579N	(*)
STREETFIGHTER 848	12' - 16'	HI-TECH II	LEFT	9578N	(*)
STREETFIGHTER 848	12' - 16'	HI-TECH III	RIGHT	9579N	(*)
STREETFIGHTER 848	12' - 16'	HI-TECH III	LEFT	9578N	(*)
STREETFIGHTER 848	12' - 16'	GT	RIGHT	9981N	(*)
STREETFIGHTER 848	12' - 16'	GT	LEFT	9982N	(*)
STREETFIGHTER 848	12' - 16'	F1	RIGHT	9981N	(*)
STREETFIGHTER 848	12' - 16'	F1	LEFT	9982N	(*)
STREETFIGHTER 848	12' - 16'	HYPERNAKED	RIGHT	9981N	(*)
STREETFIGHTER 848	12' - 16'	HYPERNAKED	LEFT	9982N	(*)
STREETFIGHTER 848	12' - 16'	EXPLORER	RIGHT	9981N	(*)
STREETFIGHTER 848	12' - 16'	EXPLORER	LEFT	9982N	(*)
STREETFIGHTER 848	12' - 16'	GTI	RIGHT	9981N	(*)
STREETFIGHTER 848	12' - 16'	GTI	LEFT	9982N	(*)
STREETFIGHTER 848	12' - 16'	RETRO	RIGHT	9981N	(*)
STREETFIGHTER 848	12' - 16'	RETRO	LEFT	9982N	(*)
STREETFIGHTER 848	12' - 16'	MT	RIGHT	9579N	(*)
STREETFIGHTER 848	12' - 16'	MT	LEFT	9578N	(*)
STREETFIGHTER 848	12' - 16'	MG	RIGHT	9579N	(*)
STREETFIGHTER 848	12' - 16'	MG	LEFT	9578N	(*)
STREETFIGHTER 848	12' - 16'	RS1	RIGHT	9579N	(*)
STREETFIGHTER 848	12' - 16'	RS1	LEFT	9578N	(*)
STREETFIGHTER 848	12' - 16'	RS2	RIGHT	9579N	(*)
STREETFIGHTER 848	12' - 16'	RS2	LEFT	9578N	(*)
STREETFIGHTER 848	12' - 16'	Z1	RIGHT	9579N	(*)
STREETFIGHTER 848	12' - 16'	Z1	LEFT	9578N	(*)
STREETFIGHTER 1100/S	09' - 13'	HI-TECH I	RIGHT	9579N	(*)
STREETFIGHTER 1100/S	09' - 13'	HI-TECH I	LEFT	9578N	(*)
STREETFIGHTER 1100/S		HI-TECH II	RIGHT	9579N	(*)
STREETFIGHTER 1100/S		HI-TECH II	LEFT	9578N	(*)
STREETFIGHTER 1100/S		HI-TECH III	RIGHT	9579N	(*)
STREETFIGHTER 1100/S		HI-TECH III	LEFT	9578N	(*)
STREETFIGHTER 1100/S		GT	RIGHT	9981N	(*)
STREETFIGHTER 1100/S		GT	LEFT	9982N	(*)
STREETFIGHTER 1100/S		F1	RIGHT	9981N	(*)
STREETFIGHTER 1100/S		F1	LEFT	9982N	(*)
STREETFIGHTER 1100/S		HYPERNAKED	RIGHT	9981N	(*)
STREETFIGHTER 1100/S		HYPERNAKED	LEFT	9982N	(*)
STREETFIGHTER 1100/S		EXPLORER	RIGHT	9981N	(*)



N
Black

(*) Check price with your distributor.

IMPORTANT: Indicate code color after part#. Example: 0973A.

ADAPTORS TO HANDLEBAR REARVIEW MIRRORS

HI-TECH PARTS | TYPE OF REAR MIRROR:

2019
MODELS:
www.puig.tv



EXPLORER



F1



GT



GTI



HI-TECH I



HI-TECH II



HI-TECH III



HYPERNAILED



MG



MT



RETRO



RS1



RS2



Z1

MODEL	YEAR	TYPE OF REAR MIRROR	SIDE	REF. ADAPTOR	N
STREETFIGHTER 1100/S		EXPLORER	LEFT	9982N	(*)
STREETFIGHTER 1100/S		GTI	RIGHT	9981N	(*)
STREETFIGHTER 1100/S		GTI	LEFT	9982N	(*)
STREETFIGHTER 1100/S		RETRO	RIGHT	9981N	(*)
STREETFIGHTER 1100/S		RETRO	LEFT	9982N	(*)
STREETFIGHTER 1100/S		MT	RIGHT	9579N	(*)
STREETFIGHTER 1100/S		MT	LEFT	9578N	(*)
STREETFIGHTER 1100/S		MG	RIGHT	9579N	(*)
STREETFIGHTER 1100/S		MG	LEFT	9578N	(*)
STREETFIGHTER 1100/S		RS1	RIGHT	9579N	(*)
STREETFIGHTER 1100/S		RS1	LEFT	9578N	(*)
STREETFIGHTER 1100/S		RS2	RIGHT	9579N	(*)
STREETFIGHTER 1100/S		RS2	LEFT	9578N	(*)
STREETFIGHTER 1100/S		Z1	RIGHT	9579N	(*)
STREETFIGHTER 1100/S		Z1	LEFT	9578N	(*)
MONSTER 696	08' - 14'	HI-TECH I	RIGHT	9579N	(*)
MONSTER 696	08' - 14'	HI-TECH I	LEFT	9578N	(*)
MONSTER 696	08' - 14'	HI-TECH II	RIGHT	9579N	(*)
MONSTER 696	08' - 14'	HI-TECH II	LEFT	9578N	(*)
MONSTER 696	08' - 14'	HI-TECH III	RIGHT	9579N	(*)
MONSTER 696	08' - 14'	HI-TECH III	LEFT	9578N	(*)
MONSTER 696	08' - 14'	GT	RIGHT	9981N	(*)
MONSTER 696	08' - 14'	GT	LEFT	9982N	(*)
MONSTER 696	08' - 14'	F1	RIGHT	9981N	(*)
MONSTER 696	08' - 14'	F1	LEFT	9982N	(*)
MONSTER 696	08' - 14'	HYPERNAILED	RIGHT	9981N	(*)
MONSTER 696	08' - 14'	HYPERNAILED	LEFT	9982N	(*)
MONSTER 696	08' - 14'	EXPLORER	RIGHT	9981N	(*)
MONSTER 696	08' - 14'	EXPLORER	LEFT	9982N	(*)
MONSTER 696	08' - 14'	GTI	RIGHT	9981N	(*)
MONSTER 696	08' - 14'	GTI	LEFT	9982N	(*)
MONSTER 696	08' - 14'	RETRO	RIGHT	9981N	(*)
MONSTER 696	08' - 14'	RETRO	LEFT	9982N	(*)
MONSTER 696	08' - 14'	MT	RIGHT	9579N	(*)
MONSTER 696	08' - 14'	MT	LEFT	9578N	(*)

MODEL	YEAR	TYPE OF REAR MIRROR	SIDE	REF. ADAPTOR	N
MONSTER 696	08' - 14'	MG	RIGHT	9579N	(*)
MONSTER 696	08' - 14'	MG	LEFT	9578N	(*)
MONSTER 696	08' - 14'	RS1	RIGHT	9579N	(*)
MONSTER 696	08' - 14'	RS1	LEFT	9578N	(*)
MONSTER 696	08' - 14'	RS2	RIGHT	9579N	(*)
MONSTER 696	08' - 14'	RS2	LEFT	9578N	(*)
MONSTER 696	08' - 14'	Z1	RIGHT	9579N	(*)
MONSTER 696	08' - 14'	Z1	LEFT	9578N	(*)
MONSTER 796	10' - 14'	HI-TECH I	RIGHT	9579N	(*)
MONSTER 796	10' - 14'	HI-TECH I	LEFT	9578N	(*)
MONSTER 796	10' - 14'	HI-TECH II	RIGHT	9579N	(*)
MONSTER 796	10' - 14'	HI-TECH II	LEFT	9578N	(*)
MONSTER 796	10' - 14'	HI-TECH III	RIGHT	9579N	(*)
MONSTER 796	10' - 14'	HI-TECH III	LEFT	9578N	(*)
MONSTER 796	10' - 14'	GT	RIGHT	9981N	(*)
MONSTER 796	10' - 14'	GT	LEFT	9982N	(*)
MONSTER 796	10' - 14'	F1	RIGHT	9981N	(*)
MONSTER 796	10' - 14'	F1	LEFT	9982N	(*)
MONSTER 796	10' - 14'	HYPERNAKED	RIGHT	9981N	(*)
MONSTER 796	10' - 14'	HYPERNAKED	LEFT	9982N	(*)
MONSTER 796	10' - 14'	EXPLORER	RIGHT	9981N	(*)
MONSTER 796	10' - 14'	EXPLORER	LEFT	9982N	(*)
MONSTER 796	10' - 14'	GTI	RIGHT	9981N	(*)
MONSTER 796	10' - 14'	GTI	LEFT	9982N	(*)
MONSTER 796	10' - 14'	RETRO	RIGHT	9981N	(*)
MONSTER 796	10' - 14'	RETRO	LEFT	9982N	(*)
MONSTER 796	10' - 14'	MT	RIGHT	9579N	(*)
MONSTER 796	10' - 14'	MT	LEFT	9578N	(*)
MONSTER 796	10' - 14'	MG	RIGHT	9579N	(*)
MONSTER 796	10' - 14'	MG	LEFT	9578N	(*)
MONSTER 796	10' - 14'	RS1	RIGHT	9579N	(*)
MONSTER 796	10' - 14'	RS1	LEFT	9578N	(*)
MONSTER 796	10' - 14'	RS2	RIGHT	9579N	(*)
MONSTER 796	10' - 14'	RS2	LEFT	9578N	(*)
MONSTER 796	10' - 14'	Z1	RIGHT	9579N	(*)
MONSTER 796	10' - 14'	Z1	LEFT	9578N	(*)
MONSTER 1100	09' - 10'	HI-TECH I	RIGHT	9579N	(*)
MONSTER 1100	09' - 10'	HI-TECH I	LEFT	9578N	(*)
MONSTER 1100	09' - 10'	HI-TECH II	RIGHT	9579N	(*)
MONSTER 1100	09' - 10'	HI-TECH II	LEFT	9578N	(*)
MONSTER 1100	09' - 10'	HI-TECH III	RIGHT	9579N	(*)
MONSTER 1100	09' - 10'	HI-TECH III	LEFT	9578N	(*)
MONSTER 1100	09' - 10'	GT	RIGHT	9981N	(*)



N
Black

(*) Check price with your distributor.

IMPORTANT: Indicate code color after part#. Example: 0973A.

ADAPTORS TO HANDLEBAR REARVIEW MIRRORS

HI-TECH PARTS | TYPE OF REAR MIRROR:

2019
MODELS:
www.puig.tv



EXPLORER



F1



GT



GTI



HI-TECH I



HI-TECH II



HI-TECH III



HYPERNAKED



MG



MT



RETRO



RS1



RS2



Z1

MODEL	YEAR	TYPE OF REAR MIRROR	SIDE	REF. ADAPTOR	N
MONSTER 1100	09' - 10'	GT	LEFT	9982N	(*)
MONSTER 1100	09' - 10'	F1	RIGHT	9981N	(*)
MONSTER 1100	09' - 10'	F1	LEFT	9982N	(*)
MONSTER 1100	09' - 10'	HYPERNAKED	RIGHT	9981N	(*)
MONSTER 1100	09' - 10'	HYPERNAKED	LEFT	9982N	(*)
MONSTER 1100	09' - 10'	EXPLORER	RIGHT	9981N	(*)
MONSTER 1100	09' - 10'	EXPLORER	LEFT	9982N	(*)
MONSTER 1100	09' - 10'	GTI	RIGHT	9981N	(*)
MONSTER 1100	09' - 10'	GTI	LEFT	9982N	(*)
MONSTER 1100	09' - 10'	RETRO	RIGHT	9981N	(*)
MONSTER 1100	09' - 10'	RETRO	LEFT	9982N	(*)
MONSTER 1100	09' - 10'	MT	RIGHT	9579N	(*)
MONSTER 1100	09' - 10'	MT	LEFT	9578N	(*)
MONSTER 1100	09' - 10'	MG	RIGHT	9579N	(*)
MONSTER 1100	09' - 10'	MG	LEFT	9578N	(*)
MONSTER 1100	09' - 10'	RS1	RIGHT	9579N	(*)
MONSTER 1100	09' - 10'	RS1	LEFT	9578N	(*)
MONSTER 1100	09' - 10'	RS2	RIGHT	9579N	(*)
MONSTER 1100	09' - 10'	RS2	LEFT	9578N	(*)
MONSTER 1100	09' - 10'	Z1	RIGHT	9579N	(*)
MONSTER 1100	09' - 10'	Z1	LEFT	9578N	(*)
MONSTER 1100 EVO	11' - 13'	HI-TECH I	RIGHT	9579N	(*)
MONSTER 1100 EVO	11' - 13'	HI-TECH I	LEFT	9578N	(*)
MONSTER 1100 EVO	11' - 13'	HI-TECH II	RIGHT	9579N	(*)
MONSTER 1100 EVO	11' - 13'	HI-TECH II	LEFT	9578N	(*)
MONSTER 1100 EVO	11' - 13'	HI-TECH III	RIGHT	9579N	(*)
MONSTER 1100 EVO	11' - 13'	HI-TECH III	LEFT	9578N	(*)
MONSTER 1100 EVO	11' - 13'	GT	RIGHT	9981N	(*)
MONSTER 1100 EVO	11' - 13'	GT	LEFT	9982N	(*)
MONSTER 1100 EVO	11' - 13'	F1	RIGHT	9981N	(*)
MONSTER 1100 EVO	11' - 13'	F1	LEFT	9982N	(*)
MONSTER 1100 EVO	11' - 13'	HYPERNAKED	RIGHT	9981N	(*)
MONSTER 1100 EVO	11' - 13'	HYPERNAKED	LEFT	9982N	(*)
MONSTER 1100 EVO	11' - 13'	EXPLORER	RIGHT	9981N	(*)
MONSTER 1100 EVO	11' - 13'	EXPLORER	LEFT	9982N	(*)

MODEL	YEAR	TYPE OF REAR MIRROR	SIDE	REF. ADAPTOR	N
MONSTER 1100 EVO	11' - 13'	GTI	RIGHT	9981N	(*)
MONSTER 1100 EVO	11' - 13'	GTI	LEFT	9982N	(*)
MONSTER 1100 EVO	11' - 13'	RETRO	RIGHT	9981N	(*)
MONSTER 1100 EVO	11' - 13'	RETRO	LEFT	9982N	(*)
MONSTER 1100 EVO	11' - 13'	MT	RIGHT	9579N	(*)
MONSTER 1100 EVO	11' - 13'	MT	LEFT	9578N	(*)
MONSTER 1100 EVO	11' - 13'	MG	RIGHT	9579N	(*)
MONSTER 1100 EVO	11' - 13'	MG	LEFT	9578N	(*)
MONSTER 1100 EVO	11' - 13'	RS1	RIGHT	9579N	(*)
MONSTER 1100 EVO	11' - 13'	RS1	LEFT	9578N	(*)
MONSTER 1100 EVO	11' - 13'	RS2	RIGHT	9579N	(*)
MONSTER 1100 EVO	11' - 13'	RS2	LEFT	9578N	(*)
MONSTER 1100 EVO	11' - 13'	Z1	RIGHT	9579N	(*)
MONSTER 1100 EVO	11' - 13'	Z1	LEFT	9578N	(*)
MONSTER 797	17' -18'	HI-TECH I	RIGHT	9579N	(*)
MONSTER 797	17' -18'	HI-TECH I	LEFT	9578N	(*)
MONSTER 797	17' -18'	HI-TECH II	RIGHT	9579N	(*)
MONSTER 797	17' -18'	HI-TECH II	LEFT	9578N	(*)
MONSTER 797	17' -18'	HI-TECH III	RIGHT	9579N	(*)
MONSTER 797	17' -18'	HI-TECH III	LEFT	9578N	(*)
MONSTER 797	17' -18'	GT	RIGHT	9981N	(*)
MONSTER 797	17' -18'	GT	LEFT	9982N	(*)
MONSTER 797	17' -18'	F1	RIGHT	9981N	(*)
MONSTER 797	17' -18'	F1	LEFT	9982N	(*)
MONSTER 797	17' -18'	HYPERNAKED	RIGHT	9981N	(*)
MONSTER 797	17' -18'	HYPERNAKED	LEFT	9982N	(*)
MONSTER 797	17' -18'	EXPLORER	RIGHT	9981N	(*)
MONSTER 797	17' -18'	EXPLORER	LEFT	9982N	(*)
MONSTER 797	17' -18'	GTI	RIGHT	9981N	(*)
MONSTER 797	17' -18'	GTI	LEFT	9982N	(*)
MONSTER 797	17' -18'	RETRO	RIGHT	9981N	(*)
MONSTER 797	17' -18'	RETRO	LEFT	9982N	(*)
MONSTER 797	17' -18'	MT	RIGHT	9579N	(*)
MONSTER 797	17' -18'	MT	LEFT	9578N	(*)
MONSTER 797	17' -18'	MG	RIGHT	9579N	(*)
MONSTER 797	17' -18'	MG	LEFT	9578N	(*)
MONSTER 797	17' -18'	RS1	RIGHT	9579N	(*)
MONSTER 797	17' -18'	RS1	LEFT	9578N	(*)
MONSTER 797	17' -18'	RS2	RIGHT	9579N	(*)
MONSTER 797	17' -18'	RS2	LEFT	9578N	(*)
MONSTER 797	17' -18'	Z1	RIGHT	9579N	(*)
MONSTER 797	17' -18'	Z1	LEFT	9578N	(*)
MONSTER 821/1200/S	14' - 18'	HI-TECH I	RIGHT	9579N	(*)



N
Black

(*) Check price with your distributor.

IMPORTANT: Indicate code color after part#. Example: 0973A.

ADAPTORS TO HANDLEBAR REARVIEW MIRRORS

HI-TECH PARTS | TYPE OF REAR MIRROR:

2019
MODELS:
www.puig.tv

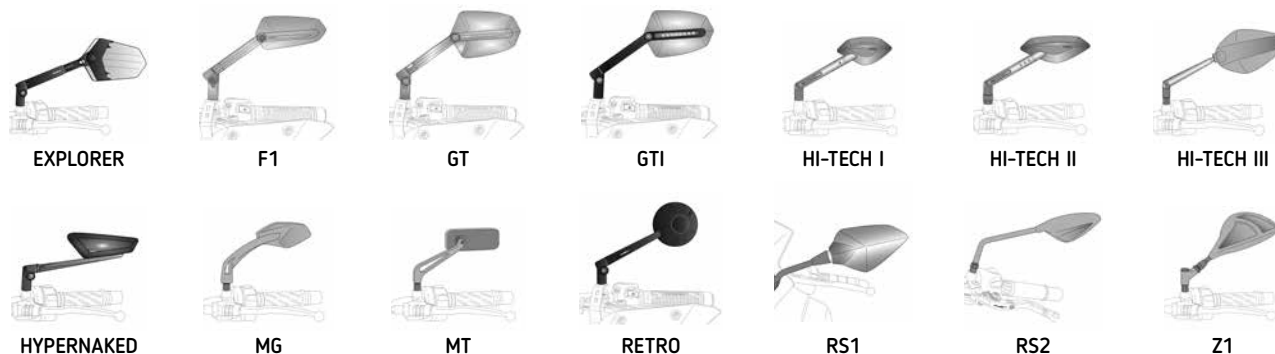

MODEL	YEAR	TYPE OF REAR MIRROR	SIDE	REF. ADAPTOR	N
MONSTER 821/1200/S	14' - 18'	HI-TECH I	LEFT	9578N	(*)
MONSTER 821/1200/S	14' - 18'	HI-TECH II	RIGHT	9579N	(*)
MONSTER 821/1200/S	14' - 18'	HI-TECH II	LEFT	9578N	(*)
MONSTER 821/1200/S	14' - 18'	HI-TECH III	RIGHT	9579N	(*)
MONSTER 821/1200/S	14' - 18'	HI-TECH III	LEFT	9578N	(*)
MONSTER 821/1200/S	14' - 18'	GT	RIGHT	9981N	(*)
MONSTER 821/1200/S	14' - 18'	GT	LEFT	9982N	(*)
MONSTER 821/1200/S	14' - 18'	F1	RIGHT	9981N	(*)
MONSTER 821/1200/S	14' - 18'	F1	LEFT	9982N	(*)
MONSTER 821/1200/S	14' - 18'	HYPERNAKED	RIGHT	9981N	(*)
MONSTER 821/1200/S	14' - 18'	HYPERNAKED	LEFT	9982N	(*)
MONSTER 821/1200/S	14' - 18'	EXPLORER	RIGHT	9981N	(*)
MONSTER 821/1200/S	14' - 18'	EXPLORER	LEFT	9982N	(*)
MONSTER 821/1200/S	14' - 18'	GTI	RIGHT	9981N	(*)
MONSTER 821/1200/S	14' - 18'	GTI	LEFT	9982N	(*)
MONSTER 821/1200/S	14' - 18'	RETRO	RIGHT	9981N	(*)
MONSTER 821/1200/S	14' - 18'	RETRO	LEFT	9982N	(*)
MONSTER 821/1200/S	14' - 18'	MT	RIGHT	9579N	(*)
MONSTER 821/1200/S	14' - 18'	MT	LEFT	9578N	(*)
MONSTER 821/1200/S	14' - 18'	MG	RIGHT	9579N	(*)
MONSTER 821/1200/S	14' - 18'	MG	LEFT	9578N	(*)
MONSTER 821/1200/S	14' - 18'	RS1	RIGHT	9579N	(*)
MONSTER 821/1200/S	14' - 18'	RS1	LEFT	9578N	(*)
MONSTER 821/1200/S	14' - 18'	RS2	RIGHT	9579N	(*)
MONSTER 821/1200/S	14' - 18'	RS2	LEFT	9578N	(*)
MONSTER 821/1200/S	14' - 18'	Z1	RIGHT	9579N	(*)
MONSTER 821/1200/S	14' - 18'	Z1	LEFT	9578N	(*)
MONSTER 1200 R	16' - 18'	HI-TECH I	RIGHT	9579N	(*)
MONSTER 1200 R	16' - 18'	HI-TECH I	LEFT	9578N	(*)
MONSTER 1200 R	16' - 18'	HI-TECH II	RIGHT	9579N	(*)
MONSTER 1200 R	16' - 18'	HI-TECH II	LEFT	9578N	(*)
MONSTER 1200 R	16' - 18'	HI-TECH III	RIGHT	9579N	(*)
MONSTER 1200 R	16' - 18'	HI-TECH III	LEFT	9578N	(*)
MONSTER 1200 R	16' - 18'	GT	RIGHT	9981N	(*)
MONSTER 1200 R	16' - 18'	GT	LEFT	9982N	(*)

MODEL	YEAR	TYPE OF REAR MIRROR	SIDE	REF. ADAPTOR	N
MONSTER 1200 R	16' - 18'	F1	RIGHT	9981N	(*)
MONSTER 1200 R	16' - 18'	F1	LEFT	9982N	(*)
MONSTER 1200 R	16' - 18'	HYPERNAKED	RIGHT	9981N	(*)
MONSTER 1200 R	16' - 18'	HYPERNAKED	LEFT	9982N	(*)
MONSTER 1200 R	16' - 18'	EXPLORER	RIGHT	9981N	(*)
MONSTER 1200 R	16' - 18'	EXPLORER	LEFT	9982N	(*)
MONSTER 1200 R	16' - 18'	GTI	RIGHT	9981N	(*)
MONSTER 1200 R	16' - 18'	GTI	LEFT	9982N	(*)
MONSTER 1200 R	16' - 18'	RETRO	RIGHT	9981N	(*)
MONSTER 1200 R	16' - 18'	RETRO	LEFT	9982N	(*)
MONSTER 1200 R	16' - 18'	MT	RIGHT	9579N	(*)
MONSTER 1200 R	16' - 18'	MT	LEFT	9578N	(*)
MONSTER 1200 R	16' - 18'	MG	RIGHT	9579N	(*)
MONSTER 1200 R	16' - 18'	MG	LEFT	9578N	(*)
MONSTER 1200 R	16' - 18'	RS1	RIGHT	9579N	(*)
MONSTER 1200 R	16' - 18'	RS1	LEFT	9578N	(*)
MONSTER 1200 R	16' - 18'	RS2	RIGHT	9579N	(*)
MONSTER 1200 R	16' - 18'	RS2	LEFT	9578N	(*)
MONSTER 1200 R	16' - 18'	Z1	RIGHT	9579N	(*)
MONSTER 1200 R	16' - 18'	Z1	LEFT	9578N	(*)
MULTISTRADA 1200/S	15' - 17'	HI-TECH I	RIGHT	9579N	(*)
MULTISTRADA 1200/S	15' - 17'	HI-TECH I	LEFT	9578N	(*)
MULTISTRADA 1200/S	15' - 17'	HI-TECH II	RIGHT	9579N	(*)
MULTISTRADA 1200/S	15' - 17'	HI-TECH II	LEFT	9578N	(*)
MULTISTRADA 1200/S	15' - 17'	HI-TECH III	RIGHT	9579N	(*)
MULTISTRADA 1200/S	15' - 17'	HI-TECH III	LEFT	9578N	(*)
MULTISTRADA 1200/S	15' - 17'	GT	RIGHT	9981N	(*)
MULTISTRADA 1200/S	15' - 17'	GT	LEFT	9982N	(*)
MULTISTRADA 1200/S	15' - 17'	F1	RIGHT	9981N	(*)
MULTISTRADA 1200/S	15' - 17'	F1	LEFT	9982N	(*)
MULTISTRADA 1200/S	15' - 17'	HYPERNAKED	RIGHT	9981N	(*)
MULTISTRADA 1200/S	15' - 17'	HYPERNAKED	LEFT	9982N	(*)
MULTISTRADA 1200/S	15' - 17'	EXPLORER	RIGHT	9981N	(*)
MULTISTRADA 1200/S	15' - 17'	EXPLORER	LEFT	9982N	(*)
MULTISTRADA 1200/S	15' - 17'	GTI	RIGHT	9981N	(*)
MULTISTRADA 1200/S	15' - 17'	GTI	LEFT	9982N	(*)
MULTISTRADA 1200/S	15' - 17'	RETRO	RIGHT	9981N	(*)
MULTISTRADA 1200/S	15' - 17'	RETRO	LEFT	9982N	(*)
MULTISTRADA 1200/S	15' - 17'	MT	RIGHT	9579N	(*)
MULTISTRADA 1200/S	15' - 17'	MT	LEFT	9578N	(*)
MULTISTRADA 1200/S	15' - 17'	MG	RIGHT	9579N	(*)
MULTISTRADA 1200/S	15' - 17'	MG	LEFT	9578N	(*)
MULTISTRADA 1200/S	15' - 17'	RS1	RIGHT	9579N	(*)



N
Black

(*) Check price with your distributor.

IMPORTANT: Indicate code color after part#. Example: 0973A.

ADAPTORS TO HANDLEBAR REARVIEW MIRRORS

HI-TECH PARTS | TYPE OF REAR MIRROR:

2019
MODELS:
www.puig.tv

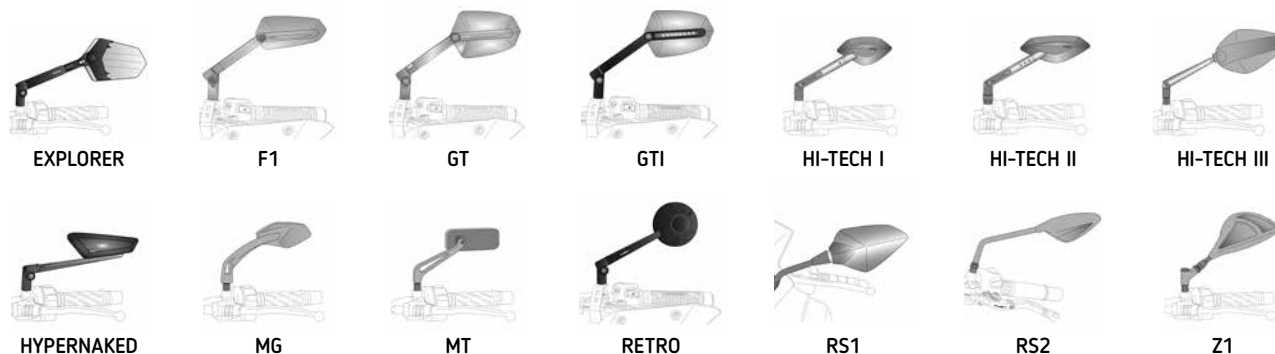

MODEL	YEAR	TYPE OF REAR MIRROR	SIDE	REF. ADAPTOR	N
MULTISTRADA 1200/S	15' - 17'	RS1	LEFT	9578N	(*)
MULTISTRADA 1200/S	15' - 17'	RS2	RIGHT	9579N	(*)
MULTISTRADA 1200/S	15' - 17'	RS2	LEFT	9578N	(*)
MULTISTRADA 1200/S	15' - 17'	Z1	RIGHT	9579N	(*)
MULTISTRADA 1200/S	15' - 17'	Z1	LEFT	9578N	(*)
MULTISTRADA 1200 PIKES PEAK	16' - 17'	HI-TECH I	RIGHT	9579N	(*)
MULTISTRADA 1200 PIKES PEAK	16' - 17'	HI-TECH I	LEFT	9578N	(*)
MULTISTRADA 1200 PIKES PEAK	16' - 17'	HI-TECH II	RIGHT	9579N	(*)
MULTISTRADA 1200 PIKES PEAK	16' - 17'	HI-TECH II	LEFT	9578N	(*)
MULTISTRADA 1200 PIKES PEAK	16' - 17'	HI-TECH III	RIGHT	9579N	(*)
MULTISTRADA 1200 PIKES PEAK	16' - 17'	HI-TECH III	LEFT	9578N	(*)
MULTISTRADA 1200 PIKES PEAK	16' - 17'	GT	RIGHT	9981N	(*)
MULTISTRADA 1200 PIKES PEAK	16' - 17'	GT	LEFT	9982N	(*)
MULTISTRADA 1200 PIKES PEAK	16' - 17'	F1	RIGHT	9981N	(*)
MULTISTRADA 1200 PIKES PEAK	16' - 17'	F1	LEFT	9982N	(*)
MULTISTRADA 1200 PIKES PEAK	16' - 17'	HYPERNAILED	RIGHT	9981N	(*)
MULTISTRADA 1200 PIKES PEAK	16' - 17'	HYPERNAILED	LEFT	9982N	(*)
MULTISTRADA 1200 PIKES PEAK	16' - 17'	EXPLORER	RIGHT	9981N	(*)
MULTISTRADA 1200 PIKES PEAK	16' - 17'	EXPLORER	LEFT	9982N	(*)
MULTISTRADA 1200 PIKES PEAK	16' - 17'	GTI	RIGHT	9981N	(*)
MULTISTRADA 1200 PIKES PEAK	16' - 17'	GTI	LEFT	9982N	(*)
MULTISTRADA 1200 PIKES PEAK	16' - 17'	RETRO	RIGHT	9981N	(*)
MULTISTRADA 1200 PIKES PEAK	16' - 17'	RETRO	LEFT	9982N	(*)
MULTISTRADA 1200 PIKES PEAK	16' - 17'	MT	RIGHT	9579N	(*)
MULTISTRADA 1200 PIKES PEAK	16' - 17'	MT	LEFT	9578N	(*)
MULTISTRADA 1200 PIKES PEAK	16' - 17'	MG	RIGHT	9579N	(*)
MULTISTRADA 1200 PIKES PEAK	16' - 17'	MG	LEFT	9578N	(*)
MULTISTRADA 1200 PIKES PEAK	16' - 17'	RS1	RIGHT	9579N	(*)
MULTISTRADA 1200 PIKES PEAK	16' - 17'	RS1	LEFT	9578N	(*)
MULTISTRADA 1200 PIKES PEAK	16' - 17'	RS2	RIGHT	9579N	(*)
MULTISTRADA 1200 PIKES PEAK	16' - 17'	RS2	LEFT	9578N	(*)
MULTISTRADA 1200 PIKES PEAK	16' - 17'	Z1	RIGHT	9579N	(*)
MULTISTRADA 1200 PIKES PEAK	16' - 17'	Z1	LEFT	9578N	(*)
MULTISTRADA 1200 ENDURO	16' - 17'	HI-TECH I	RIGHT	9579N	(*)
MULTISTRADA 1200 ENDURO	16' - 17'	HI-TECH I	LEFT	9578N	(*)

MODEL	YEAR	TYPE OF REAR MIRROR	SIDE	REF. ADAPTOR	N
MULTISTRADA 1200 ENDURO	16' - 17'	HI-TECH II	RIGHT	9579N	(*)
MULTISTRADA 1200 ENDURO	16' - 17'	HI-TECH II	LEFT	9578N	(*)
MULTISTRADA 1200 ENDURO	16' - 17'	HI-TECH III	RIGHT	9579N	(*)
MULTISTRADA 1200 ENDURO	16' - 17'	HI-TECH III	LEFT	9578N	(*)
MULTISTRADA 1200 ENDURO	16' - 17'	GT	RIGHT	9981N	(*)
MULTISTRADA 1200 ENDURO	16' - 17'	GT	LEFT	9982N	(*)
MULTISTRADA 1200 ENDURO	16' - 17'	F1	RIGHT	9981N	(*)
MULTISTRADA 1200 ENDURO	16' - 17'	F1	LEFT	9982N	(*)
MULTISTRADA 1200 ENDURO	16' - 17'	HYPERNAKED	RIGHT	9981N	(*)
MULTISTRADA 1200 ENDURO	16' - 17'	HYPERNAKED	LEFT	9982N	(*)
MULTISTRADA 1200 ENDURO	16' - 17'	EXPLORER	RIGHT	9981N	(*)
MULTISTRADA 1200 ENDURO	16' - 17'	EXPLORER	LEFT	9982N	(*)
MULTISTRADA 1200 ENDURO	16' - 17'	GTI	RIGHT	9981N	(*)
MULTISTRADA 1200 ENDURO	16' - 17'	GTI	LEFT	9982N	(*)
MULTISTRADA 1200 ENDURO	16' - 17'	RETRO	RIGHT	9981N	(*)
MULTISTRADA 1200 ENDURO	16' - 17'	RETRO	LEFT	9982N	(*)
MULTISTRADA 1200 ENDURO	16' - 17'	MT	RIGHT	9579N	(*)
MULTISTRADA 1200 ENDURO	16' - 17'	MT	LEFT	9578N	(*)
MULTISTRADA 1200 ENDURO	16' - 17'	MG	RIGHT	9579N	(*)
MULTISTRADA 1200 ENDURO	16' - 17'	MG	LEFT	9578N	(*)
MULTISTRADA 1200 ENDURO	16' - 17'	RS1	RIGHT	9579N	(*)
MULTISTRADA 1200 ENDURO	16' - 17'	RS1	LEFT	9578N	(*)
MULTISTRADA 1200 ENDURO	16' - 17'	RS2	RIGHT	9579N	(*)
MULTISTRADA 1200 ENDURO	16' - 17'	RS2	LEFT	9578N	(*)
MULTISTRADA 1200 ENDURO	16' - 17'	Z1	RIGHT	9579N	(*)
MULTISTRADA 1200 ENDURO	16' - 17'	Z1	LEFT	9578N	(*)
TRIUMPH					
BONNEVILLE T100/T120	16' - 18'	HI-TECH I	RIGHT	9509N	(*)
BONNEVILLE T100/T120	16' - 18'	HI-TECH I	LEFT	9509N	(*)
BONNEVILLE T100/T120	16' - 18'	HI-TECH II	RIGHT	9509N	(*)
BONNEVILLE T100/T120	16' - 18'	HI-TECH II	LEFT	9509N	(*)
BONNEVILLE T100/T120	16' - 18'	HI-TECH III	RIGHT	9509N	(*)
BONNEVILLE T100/T120	16' - 18'	HI-TECH III	LEFT	9509N	(*)
BONNEVILLE T100/T120	16' - 18'	GT	RIGHT	9509N	(*)
BONNEVILLE T100/T120	16' - 18'	GT	LEFT	9509N	(*)
BONNEVILLE T100/T120	16' - 18'	F1	RIGHT	9509N	(*)
BONNEVILLE T100/T120	16' - 18'	F1	LEFT	9509N	(*)
BONNEVILLE T100/T120	16' - 18'	HYPERNAKED	RIGHT	9509N	(*)
BONNEVILLE T100/T120	16' - 18'	HYPERNAKED	LEFT	9509N	(*)
BONNEVILLE T100/T120	16' - 18'	EXPLORER	RIGHT	9509N	(*)
BONNEVILLE T100/T120	16' - 18'	EXPLORER	LEFT	9509N	(*)
BONNEVILLE T100/T120	16' - 18'	GTI	RIGHT	9509N	(*)
BONNEVILLE T100/T120	16' - 18'	GTI	LEFT	9509N	(*)



N
Black

(*) Check price with your distributor.

IMPORTANT: Indicate code color after part#. Example: 0973A.

ADAPTORS TO HANDLEBAR REARVIEW MIRRORS

HI-TECH PARTS | TYPE OF REAR MIRROR:

2019
MODELS:
www.puig.tv

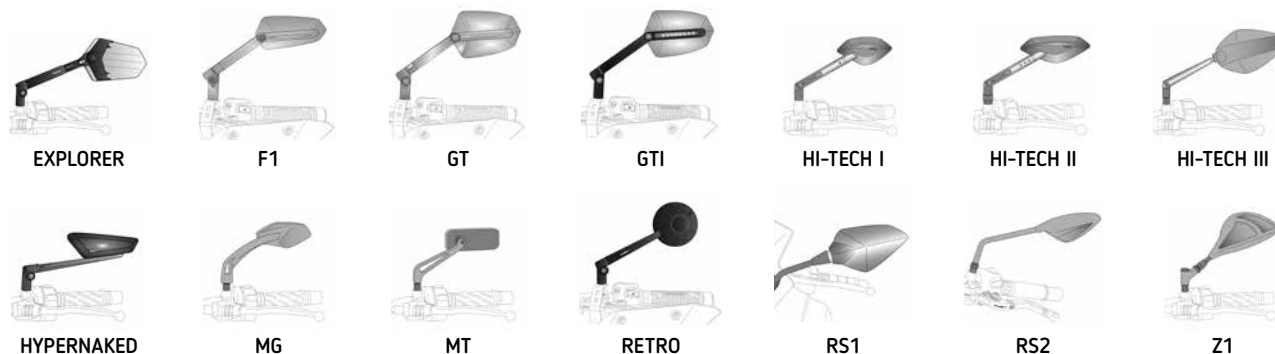

MODEL	YEAR	TYPE OF REAR MIRROR	SIDE	REF. ADAPTOR	N
BONNEVILLE T100/T120	16' - 18'	RETRO	RIGHT	9509N	(*)
BONNEVILLE T100/T120	16' - 18'	RETRO	LEFT	9509N	(*)
BONNEVILLE T100/T120	16' - 18'	MT	RIGHT	9509N	(*)
BONNEVILLE T100/T120	16' - 18'	MT	LEFT	9509N	(*)
BONNEVILLE T100/T120	16' - 18'	MG	RIGHT	9509N	(*)
BONNEVILLE T100/T120	16' - 18'	MG	LEFT	9509N	(*)
BONNEVILLE T100/T120	16' - 18'	RS1	RIGHT	9509N	(*)
BONNEVILLE T100/T120	16' - 18'	RS1	LEFT	9509N	(*)
BONNEVILLE T100/T120	16' - 18'	RS2	RIGHT	9509N	(*)
BONNEVILLE T100/T120	16' - 18'	RS2	LEFT	9509N	(*)
BONNEVILLE T100/T120	16' - 18'	Z1	RIGHT	9509N	(*)
BONNEVILLE T100/T120	16' - 18'	Z1	LEFT	9509N	(*)
YAMAHA					
T-MAX 530	12' - 16'	HI-TECH I TO LEVER AXLE	RIGHT	7517N	(*)
T-MAX 530	12' - 16'	HI-TECH I TO LEVER AXLE	LEFT	7517N	(*)
T-MAX 530	12' - 16'	HI-TECH II TO LEVER AXLE	RIGHT	7517N	(*)
T-MAX 530	12' - 16'	HI-TECH II TO LEVER AXLE	LEFT	7517N	(*)
T-MAX 530	12' - 16'	HI-TECH III TO LEVER AXLE	RIGHT	7517N	(*)
T-MAX 530	12' - 16'	HI-TECH III TO LEVER AXLE	LEFT	7517N	(*)
T-MAX 530	12' - 16'	GT TO LEVER AXLE	RIGHT	7517N	(*)
T-MAX 530	12' - 16'	GT TO LEVER AXLE	LEFT	7517N	(*)
T-MAX 530	12' - 16'	F1 TO LEVER AXLE	RIGHT	7517N	(*)
T-MAX 530	12' - 16'	F1 TO LEVER AXLE	LEFT	7517N	(*)
T-MAX 530	12' - 16'	HYPERNAKED TO LEVER AXLE	RIGHT	7517N	(*)
T-MAX 530	12' - 16'	HYPERNAKED TO LEVER AXLE	LEFT	7517N	(*)
T-MAX 530	12' - 16'	EXPLORER TO LEVER AXLE	RIGHT	7517N	(*)
T-MAX 530	12' - 16'	EXPLORER TO LEVER AXLE	LEFT	7517N	(*)
T-MAX 530	12' - 16'	GTI	RIGHT	7517N	(*)
T-MAX 530	12' - 16'	GTI	LEFT	7517N	(*)
T-MAX 530	12' - 16'	RETRO	RIGHT	7517N	(*)
T-MAX 530	12' - 16'	RETRO	LEFT	7517N	(*)
T-MAX 530	12' - 16'	MT TO LEVER AXLE	RIGHT	7517N	(*)
T-MAX 530	12' - 16'	MT TO LEVER AXLE	LEFT	7517N	(*)
T-MAX 530	12' - 16'	MG TO LEVER AXLE	RIGHT	7517N	(*)
T-MAX 530	12' - 16'	MG TO LEVER AXLE	LEFT	7517N	(*)

MODEL	YEAR	TYPE OF REAR MIRROR	SIDE	REF. ADAPTOR	N
T-MAX 530	12' - 16'	RS1 TO LEVER AXLE	RIGHT	7517N	(*)
T-MAX 530	12' - 16'	RS1 TO LEVER AXLE	LEFT	7517N	(*)
T-MAX 530	12' - 16'	RS2 TO LEVER AXLE	RIGHT	7517N	(*)
T-MAX 530	12' - 16'	RS2 TO LEVER AXLE	LEFT	7517N	(*)
T-MAX 530	12' - 16'	Z1 TO LEVER AXLE	RIGHT	7517N	(*)
T-MAX 530	12' - 16'	Z1 TO LEVER AXLE	LEFT	7517N	(*)
T-MAX 530/DX/SX	17' - 18'	HI-TECH I TO LEVER AXLE	RIGHT	7517N	(*)
T-MAX 530/DX/SX	17' - 18'	HI-TECH I TO LEVER AXLE	LEFT	7517N	(*)
T-MAX 530/DX/SX	17' - 18'	HI-TECH II TO LEVER AXLE	RIGHT	7517N	(*)
T-MAX 530/DX/SX	17' - 18'	HI-TECH II TO LEVER AXLE	LEFT	7517N	(*)
T-MAX 530/DX/SX	17' - 18'	HI-TECH III TO LEVER AXLE	RIGHT	7517N	(*)
T-MAX 530/DX/SX	17' - 18'	HI-TECH III TO LEVER AXLE	LEFT	7517N	(*)
T-MAX 530/DX/SX	17' - 18'	GT TO LEVER AXLE	RIGHT	7517N	(*)
T-MAX 530/DX/SX	17' - 18'	GT TO LEVER AXLE	LEFT	7517N	(*)
T-MAX 530/DX/SX	17' - 18'	F1 TO LEVER AXLE	RIGHT	7517N	(*)
T-MAX 530/DX/SX	17' - 18'	F1 TO LEVER AXLE	LEFT	7517N	(*)
T-MAX 530/DX/SX	17' - 18'	HYPERNAKED TO LEVER AXLE	RIGHT	7517N	(*)
T-MAX 530/DX/SX	17' - 18'	HYPERNAKED TO LEVER AXLE	LEFT	7517N	(*)
T-MAX 530/DX/SX	17' - 18'	EXPLORER TO LEVER AXLE	RIGHT	7517N	(*)
T-MAX 530/DX/SX	17' - 18'	EXPLORER TO LEVER AXLE	LEFT	7517N	(*)
T-MAX 530/DX/SX	17' - 18'	GTI	RIGHT	7517N	(*)
T-MAX 530/DX/SX	17' - 18'	GTI	LEFT	7517N	(*)
T-MAX 530/DX/SX	17' - 18'	RETRO	RIGHT	7517N	(*)
T-MAX 530/DX/SX	17' - 18'	RETRO	LEFT	7517N	(*)
T-MAX 530/DX/SX	17' - 18'	MT TO LEVER AXLE	RIGHT	7517N	(*)
T-MAX 530/DX/SX	17' - 18'	MT TO LEVER AXLE	LEFT	7517N	(*)
T-MAX 530/DX/SX	17' - 18'	MG TO LEVER AXLE	RIGHT	7517N	(*)
T-MAX 530/DX/SX	17' - 18'	MG TO LEVER AXLE	LEFT	7517N	(*)
T-MAX 530/DX/SX	17' - 18'	RS1 TO LEVER AXLE	RIGHT	7517N	(*)
T-MAX 530/DX/SX	17' - 18'	RS1 TO LEVER AXLE	LEFT	7517N	(*)
T-MAX 530/DX/SX	17' - 18'	RS2 TO LEVER AXLE	RIGHT	7517N	(*)
T-MAX 530/DX/SX	17' - 18'	RS2 TO LEVER AXLE	LEFT	7517N	(*)
T-MAX 530/DX/SX	17' - 18'	Z1 TO LEVER AXLE	RIGHT	7517N	(*)
T-MAX 530/DX/SX	17' - 18'	Z1 TO LEVER AXLE	LEFT	7517N	(*)



N
Black

(*) Check price with your distributor.

IMPORTANT: Indicate code color after part#. Example: 0973A.

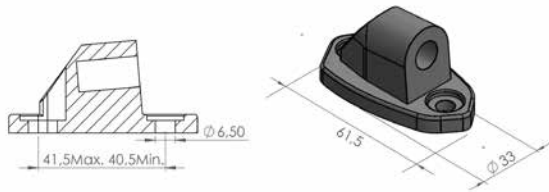

REF. 9406

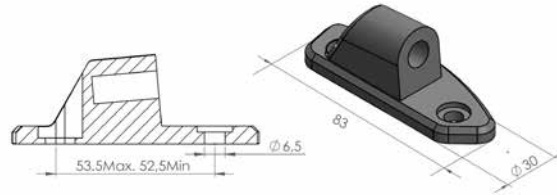

REF. 9525-9526

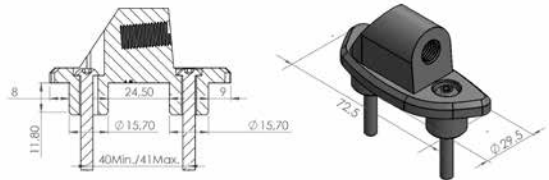

REF. 9518-9519

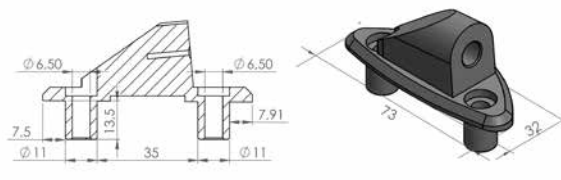

REF. 9571-9572

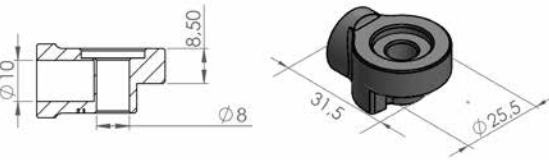
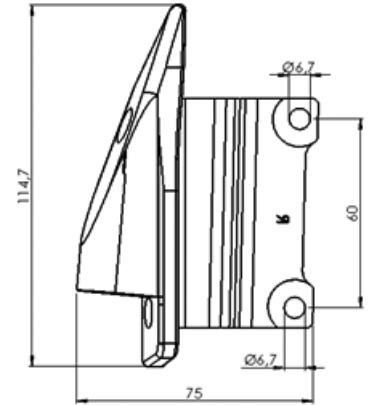

REF. 9532-9533

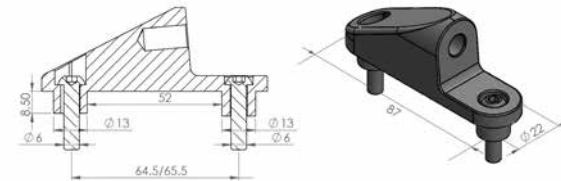

REF. 9575

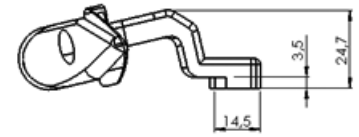

REF. 9548-9549

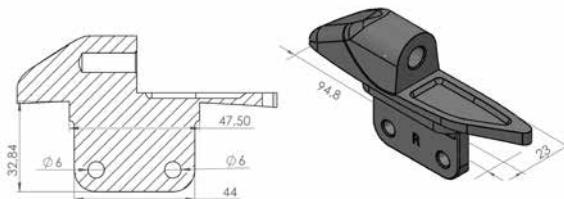

REF. 9574-9573

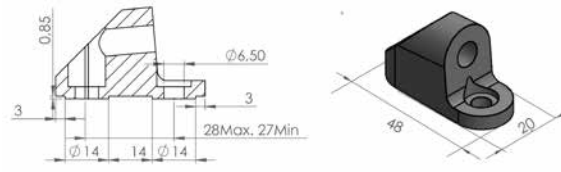

REF. 9577

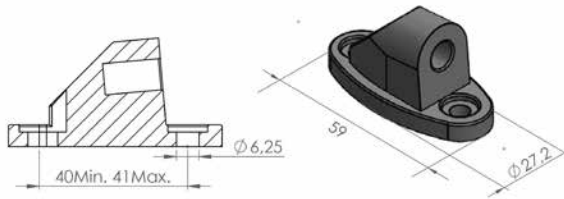
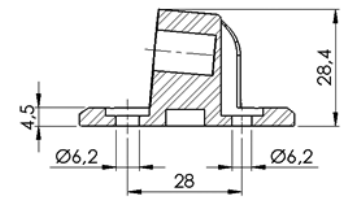

REF. 9576

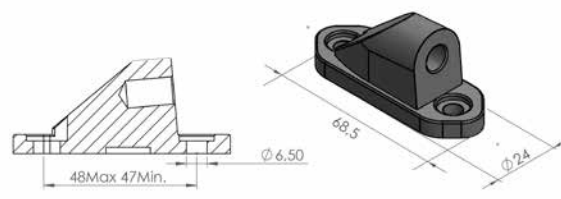

REF. 9975-9276

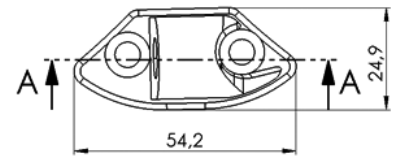

REF. 9639-9640

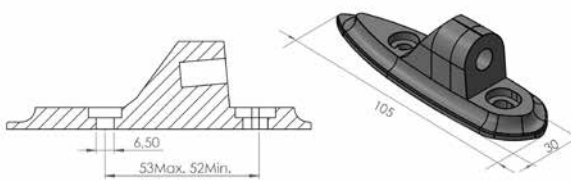

REF. 9586

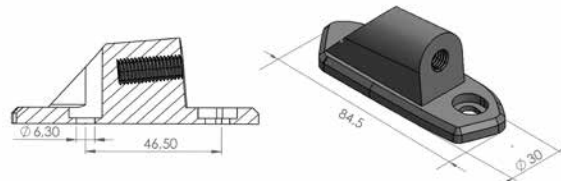

REF. 9454-9472

ADAPTORS TO ATTACH TO THE FAIRING

HI-TECH PARTS | TYPE OF REAR MIRROR:

2019
MODELS:
www.puig.tv

561



MODEL	YEAR	TYPE OF REAR MIRROR	SIDE	REF. ADAPTOR	REF. REAR MIRROR	N	C
APRILIA							
RS 50	99' - 10'	RS1	RIGHT		7342	(*)	(*)
RS 50	99' - 10'	RS1	LEFT		7343	(*)	
RS 50	99' - 10'	RS2	RIGHT		7350	(*)	(*)
RS 50	99' - 10'	RS2	LEFT		7351	(*)	(*)
RS 125	99' - 10'	RS1	RIGHT		7342	(*)	(*)
RS 125	99' - 10'	RS1	LEFT		7343	(*)	
RS 125	99' - 10'	RS2	RIGHT		7350	(*)	(*)
RS 125	99' - 10'	RS2	LEFT		7351	(*)	(*)
RS 250	99' - 05'	RS1	RIGHT		7342	(*)	(*)
RS 250	99' - 05'	RS1	LEFT		7343	(*)	
RS 250	99' - 05'	RS2	RIGHT		7350	(*)	(*)
RS 250	99' - 05'	RS2	LEFT		7351	(*)	(*)
RS4 50	11' - 18'	RS1	RIGHT		7342	(*)	(*)
RS4 50	11' - 18'	RS1	LEFT		7343	(*)	
RS4 50	11' - 18'	RS2	RIGHT		7350	(*)	(*)
RS4 50	11' - 18'	RS2	LEFT		7351	(*)	(*)
RS4 125	11' - 18'	RS1	RIGHT		7342	(*)	(*)
RS4 125	11' - 18'	RS1	LEFT		7343	(*)	
RS4 125	11' - 18'	RS2	RIGHT		7350	(*)	(*)
RS4 125	11' - 18'	RS2	LEFT		7351	(*)	(*)
RSV1000 MILLE	98' - 00'	RS1	RIGHT		7342	(*)	(*)
RSV1000 MILLE	98' - 00'	RS1	LEFT		7343	(*)	
RSV1000 MILLE	98' - 00'	RS2	RIGHT		7350	(*)	(*)
RSV1000 MILLE	98' - 00'	RS2	LEFT		7351	(*)	(*)
RSV1000 R MILLE	00' - 02'	RS1	RIGHT		7342	(*)	(*)
RSV1000 R MILLE	00' - 02'	RS1	LEFT		7343	(*)	
RSV1000 R MILLE	00' - 02'	RS2	RIGHT		7350	(*)	(*)
RSV1000 R MILLE	00' - 02'	RS2	LEFT		7351	(*)	(*)
RSV4	09' - 12'	RS1	RIGHT		7342	(*)	(*)
RSV4	09' - 12'	RS1	LEFT		7343	(*)	
RSV4	09' - 12'	RS2	RIGHT		7350	(*)	(*)
RSV4	09' - 12'	RS2	LEFT		7351	(*)	(*)
RSV4 FACTORY	13' - 14'	RS1	RIGHT		7342	(*)	(*)

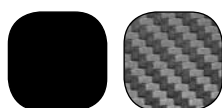

N

Black

C

Carbon Look

(*) Check price with your distributor.

IMPORTANT: Indicate code color after part#. Example: 0973A.

ADAPTORS TO ATTACH TO THE FAIRING

HI-TECH PARTS | TYPE OF REAR MIRROR:

2019
MODELS:
www.puig.tv



MODEL	YEAR	TYPE OF REAR MIRROR	SIDE	REF. ADAPTOR	REF. REAR MIRROR	N	C
RSV4 FACTORY	13' - 14'	RS1	LEFT		7343	(*)	
RSV4 FACTORY	13' - 14'	RS2	RIGHT		7350	(*)	(*)
RSV4 FACTORY	13' - 14'	RS2	LEFT		7351	(*)	(*)
RSV4 R	13' - 14'	RS1	RIGHT		7342	(*)	(*)
RSV4 R	13' - 14'	RS1	LEFT		7343	(*)	
RSV4 R	13' - 14'	RS2	RIGHT		7350	(*)	(*)
RSV4 R	13' - 14'	RS2	LEFT		7351	(*)	(*)
RSV4 RF/RR	15' - 17'	RS1	RIGHT		7342	(*)	(*)
RSV4 RF/RR	15' - 17'	RS1	LEFT		7343	(*)	
RSV4 RF/RR	15' - 17'	RS2	RIGHT		7350	(*)	(*)
RSV4 RF/RR	15' - 17'	RS2	LEFT		7351	(*)	(*)
BENELLI							
TORNADO 302 R	14' - 18'	RS1	RIGHT		7342	(*)	(*)
TORNADO 302 R	14' - 18'	RS1	LEFT		7343	(*)	
TORNADO 302 R	14' - 18'	RS2	RIGHT		7350	(*)	(*)
TORNADO 302 R	14' - 18'	RS2	LEFT		7351	(*)	(*)
BMW							
C600 SPORT	12' - 15'	HI-TECH I	RIGHT	9575N		(*)	
C600 SPORT	12' - 15'	HI-TECH I	LEFT	9575N		(*)	
C600 SPORT	12' - 15'	HI-TECH II	RIGHT	9575N		(*)	
C600 SPORT	12' - 15'	HI-TECH II	LEFT	9575N		(*)	
C600 SPORT	12' - 15'	HI-TECH III	RIGHT	9575N		(*)	
C600 SPORT	12' - 15'	HI-TECH III	LEFT	9575N		(*)	
C600 SPORT	12' - 15'	GT	RIGHT	9575N		(*)	
C600 SPORT	12' - 15'	GT	LEFT	9575N		(*)	
C600 SPORT	12' - 15'	F1	RIGHT	9575N		(*)	
C600 SPORT	12' - 15'	F1	LEFT	9575N		(*)	
C600 SPORT	12' - 15'	HYPERNAKED	RIGHT	9575N		(*)	
C600 SPORT	12' - 15'	HYPERNAKED	LEFT	9575N		(*)	
C600 SPORT	12' - 15'	EXPLORER	RIGHT	9575N		(*)	
C600 SPORT	12' - 15'	EXPLORER	LEFT	9575N		(*)	
C600 SPORT	12' - 15'	GTI	RIGHT	9575N		(*)	
C600 SPORT	12' - 15'	GTI	LEFT	9575N		(*)	
C600 SPORT	12' - 15'	RETRO	RIGHT	9575N		(*)	
C600 SPORT	12' - 15'	RETRO	LEFT	9575N		(*)	
C650 SPORT	16' - 18'	HI-TECH I	RIGHT	9575N		(*)	
C650 SPORT	16' - 18'	HI-TECH I	LEFT	9575N		(*)	
C650 SPORT	16' - 18'	HI-TECH II	RIGHT	9575N		(*)	
C650 SPORT	16' - 18'	HI-TECH II	LEFT	9575N		(*)	
C650 SPORT	16' - 18'	HI-TECH III	RIGHT	9575N		(*)	

MODEL	YEAR	TYPE OF REAR MIRROR	SIDE	REF. ADAPTOR	REF. REAR MIRROR	N	C
C650 SPORT	16' - 18'	HI-TECH III	LEFT	9575N		(*)	
C650 SPORT	16' - 18'	GT	RIGHT	9575N		(*)	
C650 SPORT	16' - 18'	GT	LEFT	9575N		(*)	
C650 SPORT	16' - 18'	F1	RIGHT	9575N		(*)	
C650 SPORT	16' - 18'	F1	LEFT	9575N		(*)	
C650 SPORT	16' - 18'	HYPERNAKED	RIGHT	9575N		(*)	
C650 SPORT	16' - 18'	HYPERNAKED	LEFT	9575N		(*)	
C650 SPORT	16' - 18'	EXPLORER	RIGHT	9575N		(*)	
C650 SPORT	16' - 18'	EXPLORER	LEFT	9575N		(*)	
C650 SPORT	16' - 18'	GTI	RIGHT	9575N		(*)	
C650 SPORT	16' - 18'	GTI	LEFT	9575N		(*)	
C650 SPORT	16' - 18'	RETRO	RIGHT	9575N		(*)	
C650 SPORT	16' - 18'	RETRO	LEFT	9575N		(*)	
F800 GT	17' - 18'	HI-TECH I	RIGHT	9518N		(*)	
F800 GT	17' - 18'	HI-TECH I	LEFT	9519N		(*)	
F800 GT	17' - 18'	HI-TECH II	RIGHT	9518N		(*)	
F800 GT	17' - 18'	HI-TECH II	LEFT	9519N		(*)	
F800 GT	17' - 18'	HI-TECH III	RIGHT	9518N		(*)	
F800 GT	17' - 18'	HI-TECH III	LEFT	9519N		(*)	
F800 GT	17' - 18'	GT	RIGHT	9518N		(*)	
F800 GT	17' - 18'	GT	LEFT	9519N		(*)	
F800 GT	17' - 18'	F1	RIGHT	9518N		(*)	
F800 GT	17' - 18'	F1	LEFT	9519N		(*)	
F800 GT	17' - 18'	HYPERNAKED	RIGHT	9518N		(*)	
F800 GT	17' - 18'	HYPERNAKED	LEFT	9519N		(*)	
F800 GT	17' - 18'	EXPLORER	RIGHT	9518N		(*)	
F800 GT	17' - 18'	EXPLORER	LEFT	9519N		(*)	
F800 GT	17' - 18'	GTI	RIGHT	9518N		(*)	
F800 GT	17' - 18'	GTI	LEFT	9519N		(*)	
F800 GT	17' - 18'	RETRO	RIGHT	9518N		(*)	
F800 GT	17' - 18'	RETRO	LEFT	9519N		(*)	
F800 GT	13' - 18'	RS1	RIGHT		7344	(*)	(*)
F800 GT	13' - 18'	RS1	LEFT		7345	(*)	(*)
F800 GT	13' - 18'	RS2	RIGHT		7352	(*)	(*)
F800 GT	13' - 18'	RS2	LEFT		7353	(*)	(*)
F800 S	06' - 11'	RS1	RIGHT		7344	(*)	(*)
F800 S	06' - 11'	RS1	LEFT		7345	(*)	(*)
F800 S	06' - 11'	RS2	RIGHT		7352	(*)	(*)
F800 S	06' - 11'	RS2	LEFT		7353	(*)	(*)
HP2 SPORT	08' - 11'	RS1	RIGHT		7343	(*)	
HP2 SPORT	08' - 11'	RS1	LEFT		7344	(*)	(*)
HP2 SPORT	08' - 11'	RS2	RIGHT		7352	(*)	(*)
HP2 SPORT	08' - 11'	RS2	LEFT		7353	(*)	(*)



N
Black

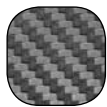

C
Carbon Look

(*) Check price with your distributor.

IMPORTANT: Indicate code color after part#. Example: 0973A.

ADAPTORS TO ATTACH TO THE FAIRING

HI-TECH PARTS | TYPE OF REAR MIRROR:

2019
MODELS:
www.puig.tv



MODEL	YEAR	TYPE OF REAR MIRROR	SIDE	REF. ADAPTOR	REF. REAR MIRROR	N	C
K1200 S	04' - 08'	RS1	RIGHT		7343	(*)	
K1200 S	04' - 08'	RS1	LEFT		7344	(*)	(*)
K1200 S	04' - 08'	RS2	RIGHT		7352	(*)	(*)
K1200 S	04' - 08'	RS2	LEFT		7353	(*)	(*)
K1300 S	09' - 16'	RS1	RIGHT		7342	(*)	(*)
K1300 S	09' - 16'	RS1	LEFT		7343	(*)	
K1300 S	09' - 16'	RS2	RIGHT		7350	(*)	(*)
K1300 S	09' - 16'	RS2	LEFT		7351	(*)	(*)
R1200 S	06' - 08'	RS1	RIGHT		7342	(*)	(*)
R1200 S	06' - 08'	RS1	LEFT		7343	(*)	
R1200 S	06' - 08'	RS2	RIGHT		7350	(*)	(*)
R1200 S	06' - 08'	RS2	LEFT		7351	(*)	(*)
R1200 RS	15' - 18'	HI-TECH I	RIGHT		CHECK WEB		
R1200 RS	15' - 18'	HI-TECH I	LEFT		CHECK WEB		
R1200 RS	15' - 18'	HI-TECH II	RIGHT		CHECK WEB		
R1200 RS	15' - 18'	HI-TECH II	LEFT		CHECK WEB		
R1200 RS	15' - 18'	HI-TECH III	RIGHT		CHECK WEB		
R1200 RS	15' - 18'	HI-TECH III	LEFT		CHECK WEB		
R1200 RS	15' - 18'	GT	RIGHT		CHECK WEB		
R1200 RS	15' - 18'	GT	LEFT		CHECK WEB		
R1200 RS	15' - 18'	F1	RIGHT		CHECK WEB		
R1200 RS	15' - 18'	F1	LEFT		CHECK WEB		
R1200 RS	15' - 18'	HYPERNAKED	RIGHT		CHECK WEB		
R1200 RS	15' - 18'	HYPERNAKED	LEFT		CHECK WEB		
R1200 RS	15' - 18'	EXPLORER	RIGHT		CHECK WEB		
R1200 RS	15' - 18'	EXPLORER	LEFT		CHECK WEB		
R1200 RS	15' - 18'	GTI	RIGHT		CHECK WEB		
R1200 RS	15' - 18'	GTI	LEFT		CHECK WEB		
R1200 RS	15' - 18'	RETRO	RIGHT		CHECK WEB		
R1200 RS	15' - 18'	RETRO	LEFT		CHECK WEB		
R1200 RS	15' - 18'	RS1	RIGHT		7342	(*)	(*)
R1200 RS	15' - 18'	RS1	LEFT		7343	(*)	
R1200 RS	15' - 18'	RS2	RIGHT		7350	(*)	(*)
R1200 RS	15' - 18'	RS2	LEFT		7351	(*)	(*)
S1000 RR	09' - 14'	RS1	RIGHT		7346	(*)	(*)
S1000 RR	09' - 14'	RS1	LEFT		7347	(*)	(*)
S1000 RR	09' - 14'	RS2	RIGHT		7354	(*)	(*)
S1000 RR	09' - 14'	RS2	LEFT		7355	(*)	(*)
S1000 RR	15' - 18'	HI-TECH I	RIGHT		CHECK WEB		
S1000 RR	15' - 18'	HI-TECH I	LEFT		CHECK WEB		

MODEL	YEAR	TYPE OF REAR MIRROR	SIDE	REF. ADAPTOR	REF. REAR MIRROR	N	C
S1000 RR	15' - 18'	HI-TECH II	RIGHT		CHECK WEB		
S1000 RR	15' - 18'	HI-TECH II	LEFT		CHECK WEB		
S1000 RR	15' - 18'	HI-TECH III	RIGHT		CHECK WEB		
S1000 RR	15' - 18'	HI-TECH III	LEFT		CHECK WEB		
S1000 RR	15' - 18'	GT	RIGHT		CHECK WEB		
S1000 RR	15' - 18'	GT	LEFT		CHECK WEB		
S1000 RR	15' - 18'	F1	RIGHT		CHECK WEB		
S1000 RR	15' - 18'	F1	LEFT		CHECK WEB		
S1000 RR	15' - 18'	HYPERNAKED	RIGHT		CHECK WEB		
S1000 RR	15' - 18'	HYPERNAKED	LEFT		CHECK WEB		
S1000 RR	15' - 18'	EXPLORER	RIGHT		CHECK WEB		
S1000 RR	15' - 18'	EXPLORER	LEFT		CHECK WEB		
S1000 RR	15' - 18'	GTI	RIGHT		CHECK WEB		
S1000 RR	15' - 18'	GTI	LEFT		CHECK WEB		
S1000 RR	15' - 18'	RETRO	RIGHT		CHECK WEB		
S1000 RR	15' - 18'	RETRO	LEFT		CHECK WEB		
DUCATI							
SUPERSPORT 939/S	17' - 18'	RS1	RIGHT		7342	(*)	(*)
SUPERSPORT 939/S	17' - 18'	RS1	LEFT		7343	(*)	
SUPERSPORT 939/S	17' - 18'	RS2	RIGHT		7350	(*)	(*)
SUPERSPORT 939/S	17' - 18'	RS2	LEFT		7351	(*)	(*)
HONDA							
CB1300S	05' - 13'	RS1	RIGHT		7344	(*)	(*)
CB1300S	05' - 13'	RS1	LEFT		7345	(*)	(*)
CB1300S	05' - 13'	RS2	RIGHT		7352	(*)	(*)
CB1300S	05' - 13'	RS2	LEFT		7353	(*)	(*)
CBF600S	04' - 14'	RS1	RIGHT		7344	(*)	(*)
CBF600S	04' - 14'	RS1	LEFT		7345	(*)	(*)
CBF600S	04' - 14'	RS2	RIGHT		7352	(*)	(*)
CBF600S	04' - 14'	RS2	LEFT		7353	(*)	(*)
CBF1000	06' - 11'	RS1	RIGHT		7344	(*)	(*)
CBF1000	06' - 11'	RS1	LEFT		7345	(*)	(*)
CBF1000	06' - 11'	RS2	RIGHT		7352	(*)	(*)
CBF1000	06' - 11'	RS2	LEFT		7353	(*)	(*)
CBF1000F	10' - 16'	RS1	RIGHT		7342	(*)	(*)
CBF1000F	10' - 16'	RS1	LEFT		7343	(*)	
CBF1000F	10' - 16'	RS2	RIGHT		7350	(*)	(*)
CBF1000F	10' - 16'	RS2	LEFT		7351	(*)	(*)
CBR600F	91' - 13'	RS1	RIGHT		7342	(*)	(*)
CBR600F	91' - 13'	RS1	LEFT		7343	(*)	
CBR600F	91' - 13'	RS2	RIGHT		7350	(*)	(*)
CBR600F	91' - 13'	RS2	LEFT		7351	(*)	(*)
CBR650F	14' - 18'	HI-TECH I	RIGHT	9576N		(*)	



N
Black

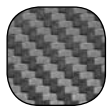

C
Carbon Look

(*) Check price with your distributor.

IMPORTANT: Indicate code color after part#. Example: 0973A.

ADAPTORS TO ATTACH TO THE FAIRING

HI-TECH PARTS | TYPE OF REAR MIRROR:

2019
MODELS:
www.puig.tv



MODEL	YEAR	TYPE OF REAR MIRROR	SIDE	REF. ADAPTOR	REF. REAR MIRROR	N	C
CBR650F	14' - 18'	HI-TECH I	LEFT	9576N		(*)	
CBR650F	14' - 18'	HI-TECH II	RIGHT	9576N		(*)	
CBR650F	14' - 18'	HI-TECH II	LEFT	9576N		(*)	
CBR650F	14' - 18'	HI-TECH III	RIGHT	9576N		(*)	
CBR650F	14' - 18'	HI-TECH III	LEFT	9576N		(*)	
CBR650F	14' - 18'	GT	RIGHT	9576N		(*)	
CBR650F	14' - 18'	GT	LEFT	9576N		(*)	
CBR650F	14' - 18'	F1	RIGHT	9576N		(*)	
CBR650F	14' - 18'	F1	LEFT	9576N		(*)	
CBR650F	14' - 18'	HYPERNAKED	RIGHT	9576N		(*)	
CBR650F	14' - 18'	HYPERNAKED	LEFT	9576N		(*)	
CBR650F	14' - 18'	EXPLORER	RIGHT	9576N		(*)	
CBR650F	14' - 18'	EXPLORER	LEFT	9576N		(*)	
CBR650F	14' - 18'	GTI	RIGHT	9576N		(*)	
CBR650F	14' - 18'	GTI	LEFT	9576N		(*)	
CBR650F	14' - 18'	RETRO	RIGHT	9576N		(*)	
CBR650F	14' - 18'	RETRO	LEFT	9576N		(*)	
CBR650F	14' - 18'	RS1	RIGHT		7342	(*)	(*)
CBR650F	14' - 18'	RS1	LEFT		7343	(*)	
CBR650F	14' - 18'	RS2	RIGHT		7350	(*)	(*)
CBR650F	14' - 18'	RS2	LEFT		7351	(*)	(*)
CBR125R	07' - 18'	RS1	RIGHT		7346	(*)	(*)
CBR125R	07' - 18'	RS1	LEFT		7347	(*)	(*)
CBR125R	07' - 18'	RS2	RIGHT		7354	(*)	(*)
CBR125R	07' - 18'	RS2	LEFT		7355	(*)	(*)
CBR250R	11' - 14'	RS1	RIGHT		7342	(*)	(*)
CBR250R	11' - 14'	RS1	LEFT		7343	(*)	
CBR250R	11' - 14'	RS2	RIGHT		7350	(*)	(*)
CBR250R	11' - 14'	RS2	LEFT		7351	(*)	(*)
CBR300R	15' - 18'	RS1	RIGHT		7342	(*)	(*)
CBR300R	15' - 18'	RS1	LEFT		7343	(*)	
CBR300R	15' - 18'	RS2	RIGHT		7350	(*)	(*)
CBR300R	15' - 18'	RS2	LEFT		7351	(*)	(*)
CBR500R	13' - 18'	HI-TECH I	RIGHT	9576N		(*)	
CBR500R	13' - 18'	HI-TECH I	LEFT	9576N		(*)	
CBR500R	13' - 18'	HI-TECH II	RIGHT	9576N		(*)	
CBR500R	13' - 18'	HI-TECH II	LEFT	9576N		(*)	
CBR500R	13' - 18'	HI-TECH III	RIGHT	9576N		(*)	
CBR500R	13' - 18'	HI-TECH III	LEFT	9576N		(*)	
CBR500R	13' - 18'	GT	RIGHT	9576N		(*)	

MODEL	YEAR	TYPE OF REAR MIRROR	SIDE	REF. ADAPTOR	REF. REAR MIRROR	N	C
CBR500R	13' - 18'	GT	LEFT	9576N		(*)	
CBR500R	13' - 18'	F1	RIGHT	9576N		(*)	
CBR500R	13' - 18'	F1	LEFT	9576N		(*)	
CBR500R	13' - 18'	HYPERNAKED	RIGHT	9576N		(*)	
CBR500R	13' - 18'	HYPERNAKED	LEFT	9576N		(*)	
CBR500R	13' - 18'	EXPLORER	RIGHT	9576N		(*)	
CBR500R	13' - 18'	EXPLORER	LEFT	9576N		(*)	
CBR500R	13' - 18'	GTI	RIGHT	9576N		(*)	
CBR500R	13' - 18'	GTI	LEFT	9576N		(*)	
CBR500R	13' - 18'	RETRO	RIGHT	9576N		(*)	
CBR500R	13' - 18'	RETRO	LEFT	9576N		(*)	
CBR500R	13' - 18'	RS1	RIGHT		7342	(*)	(*)
CBR500R	13' - 18'	RS1	LEFT		7343	(*)	
CBR500R	13' - 18'	RS2	RIGHT		7350	(*)	(*)
CBR500R	13' - 18'	RS2	LEFT		7351	(*)	(*)
CBR600RR	13' - 16'	HI-TECH I	RIGHT	9576N		(*)	
CBR600RR	13' - 16'	HI-TECH I	LEFT	9576N		(*)	
CBR600RR	13' - 16'	HI-TECH II	RIGHT	9576N		(*)	
CBR600RR	13' - 16'	HI-TECH II	LEFT	9576N		(*)	
CBR600RR	13' - 16'	HI-TECH III	RIGHT	9576N		(*)	
CBR600RR	13' - 16'	HI-TECH III	LEFT	9576N		(*)	
CBR600RR	13' - 16'	GT	RIGHT	9576N		(*)	
CBR600RR	13' - 16'	GT	LEFT	9576N		(*)	
CBR600RR	13' - 16'	F1	RIGHT	9576N		(*)	
CBR600RR	13' - 16'	F1	LEFT	9576N		(*)	
CBR600RR	13' - 16'	HYPERNAKED	RIGHT	9576N		(*)	
CBR600RR	13' - 16'	HYPERNAKED	LEFT	9576N		(*)	
CBR600RR	13' - 16'	EXPLORER	RIGHT	9576N		(*)	
CBR600RR	13' - 16'	EXPLORER	LEFT	9576N		(*)	
CBR600RR	13' - 16'	GTI	RIGHT	9576N		(*)	
CBR600RR	13' - 16'	GTI	LEFT	9576N		(*)	
CBR600RR	13' - 16'	RETRO	RIGHT	9576N		(*)	
CBR600RR	13' - 16'	RETRO	LEFT	9576N		(*)	
CBR600RR	13' - 16'	RS1	RIGHT		7346	(*)	(*)
CBR600RR	13' - 16'	RS1	LEFT		7347	(*)	(*)
CBR600RR	13' - 16'	RS2	RIGHT		7354	(*)	(*)
CBR600RR	13' - 16'	RS2	LEFT		7355	(*)	(*)
CBR900RR FIRE BLADE	98' - 03'	RS1	RIGHT		7344	(*)	(*)
CBR900RR FIRE BLADE	98' - 03'	RS1	LEFT		7345	(*)	(*)
CBR900RR FIRE BLADE	98' - 03'	RS2	RIGHT		7352	(*)	(*)
CBR900RR FIRE BLADE	98' - 03'	RS2	LEFT		7353	(*)	(*)
CBR900RR FIRE BLADE	00' - 01'	RS1	RIGHT		7342	(*)	(*)
CBR900RR FIRE BLADE	00' - 01'	RS1	LEFT		7343	(*)	

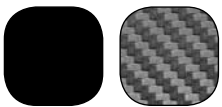

N
Black

C
Carbon Look

(*) Check price with your distributor.

IMPORTANT: Indicate code color after part#. Example: 0973A.

ADAPTORS TO ATTACH TO THE FAIRING

HI-TECH PARTS | TYPE OF REAR MIRROR:

2019
MODELS:
www.puig.tv



MODEL	YEAR	TYPE OF REAR MIRROR	SIDE	REF. ADAPTOR	REF. REAR MIRROR	N	C
CBR900RR FIRE BLADE	00' - 01'	RS2	RIGHT		7350	(*)	(*)
CBR900RR FIRE BLADE	00' - 01'	RS2	LEFT		7351	(*)	(*)
CBR1000RR FIRE BLADE	04' - 13'	RS1	RIGHT		7346	(*)	(*)
CBR1000RR FIRE BLADE	04' - 13'	RS1	LEFT		7347	(*)	(*)
CBR1000RR FIRE BLADE	04' - 13'	RS2	RIGHT		7354	(*)	(*)
CBR1000RR FIRE BLADE	04' - 13'	RS2	LEFT		7355	(*)	(*)
CBR1000RR FIRE BLADE/SP	14' - 16'	RS1	RIGHT		7346	(*)	(*)
CBR1000RR FIRE BLADE/SP	14' - 16'	RS1	LEFT		7347	(*)	(*)
CBR1000RR FIRE BLADE/SP	14' - 16'	RS2	RIGHT		7354	(*)	(*)
CBR1000RR FIRE BLADE/SP	14' - 16'	RS2	LEFT		7355	(*)	(*)
CBR1000RR FIREBLADE/SP/SP2	17' - 18'	RS1	RIGHT		7342	(*)	(*)
CBR1000RR FIREBLADE/SP/SP2	17' - 18'	RS1	LEFT		7343	(*)	(*)
CBR1000RR FIREBLADE/SP/SP2	17' - 18'	RS2	RIGHT		7350	(*)	(*)
CBR1000RR FIREBLADE/SP/SP2	17' - 18'	RS2	LEFT		7351	(*)	(*)
CBR1100XX BLACKBIRD	97' - 07'	RS1	RIGHT		7342	(*)	(*)
CBR1100XX BLACKBIRD	97' - 07'	RS1	LEFT		7343	(*)	(*)
CBR1100XX BLACKBIRD	97' - 07'	RS2	RIGHT		7350	(*)	(*)
CBR1100XX BLACKBIRD	97' - 07'	RS2	LEFT		7351	(*)	(*)
NT650V DEAUVILLE	98' - 05'	RS1	RIGHT		7342	(*)	(*)
NT650V DEAUVILLE	98' - 05'	RS1	LEFT		7343	(*)	(*)
NT650V DEAUVILLE	98' - 05'	RS2	RIGHT		7350	(*)	(*)
NT650V DEAUVILLE	98' - 05'	RS2	LEFT		7351	(*)	(*)
NT700V DEAUVILLE	06' - 17'	RS1	RIGHT		7342	(*)	(*)
NT700V DEAUVILLE	06' - 17'	RS1	LEFT		7343	(*)	(*)
NT700V DEAUVILLE	06' - 17'	RS2	RIGHT		7350	(*)	(*)
NT700V DEAUVILLE	06' - 17'	RS2	LEFT		7351	(*)	(*)
VFR800	02' - 13'	RS1	RIGHT		7342	(*)	(*)
VFR800	02' - 13'	RS1	LEFT		7343	(*)	(*)
VFR800	02' - 13'	RS2	RIGHT		7350	(*)	(*)
VFR800	02' - 13'	RS2	LEFT		7351	(*)	(*)
VFR800 F	14' - 18'	RS1	RIGHT		7344	(*)	(*)
VFR800 F	14' - 17'	RS1	LEFT		7345	(*)	(*)
VFR800 F	14' - 17'	RS2	RIGHT		7352	(*)	(*)
VFR800 F	14' - 17'	RS2	LEFT		7353	(*)	(*)
VFR1200F	10' - 16'	RS1	RIGHT		7342	(*)	(*)
VFR1200F	10' - 16'	RS1	LEFT		7343	(*)	(*)
VFR1200F	10' - 16'	RS2	RIGHT		7350	(*)	(*)
VFR1200F	10' - 16'	RS2	LEFT		7351	(*)	(*)
HYOSUNG							
GT125R	06' - 13'	RS1	RIGHT		7342	(*)	(*)

MODEL	YEAR	TYPE OF REAR MIRROR	SIDE	REF. ADAPTOR	REF. REAR MIRROR	N	C
GT125R	06' - 13'	RS1	LEFT		7343	(*)	
GT125R	06' - 13'	RS2	RIGHT		7350	(*)	(*)
GT125R	06' - 13'	RS2	LEFT		7351	(*)	(*)
GT250 iR	06' -17'	RS1	RIGHT		7342	(*)	(*)
GT250 iR	06' -17'	RS1	LEFT		7343	(*)	
GT250 iR	06' -17'	RS2	RIGHT		7350	(*)	(*)
GT250 iR	06' -17'	RS2	LEFT		7351	(*)	(*)
GT650 R	05' - 17'	RS1	RIGHT		7342	(*)	(*)
GT650 R	05' - 17'	RS1	LEFT		7343	(*)	
GT650 R	05' - 17'	RS2	RIGHT		7350	(*)	(*)
GT650 R	05' - 17'	RS2	LEFT		7351	(*)	(*)
GT650 iR	13' - 18'	RS1	RIGHT		7342	(*)	(*)
GT650 iR	13' - 18'	RS1	LEFT		7343	(*)	
GT650 iR	13' - 18'	RS2	RIGHT		7350	(*)	(*)
GT650 iR	13' - 18'	RS2	LEFT		7351	(*)	(*)
KAWASAKI							
ER-6F	06' - 16'	RS1	RIGHT		7342	(*)	(*)
ER-6F	06' - 16'	RS1	LEFT		7343	(*)	
ER-6F	06' - 16'	RS2	RIGHT		7350	(*)	(*)
ER-6F	06' - 16'	RS2	LEFT		7351	(*)	(*)
NINJA 250R	08' - 12'	RS1	RIGHT		7342	(*)	(*)
NINJA 250R	08' - 12'	RS1	LEFT		7343	(*)	
NINJA 250R	08' - 12'	RS2	RIGHT		7352	(*)	(*)
NINJA 250R	08' - 12'	RS2	LEFT		7353	(*)	(*)
NINJA 250SL	15' - 16'	HI-TECH I	RIGHT	9975N		(*)	
NINJA 250SL	15' - 16'	HI-TECH I	LEFT	9975N		(*)	
NINJA 250SL	15' - 16'	HI-TECH II	RIGHT	9975N		(*)	
NINJA 250SL	15' - 16'	HI-TECH II	LEFT	9975N		(*)	
NINJA 250SL	15' - 16'	HI-TECH III	RIGHT	9975N		(*)	
NINJA 250SL	15' - 16'	HI-TECH III	LEFT	9975N		(*)	
NINJA 250SL	15' - 16'	GT	RIGHT	9975N		(*)	
NINJA 250SL	15' - 16'	GT	LEFT	9975N		(*)	
NINJA 250SL	15' - 16'	F1	RIGHT	9975N		(*)	
NINJA 250SL	15' - 16'	F1	LEFT	9975N		(*)	
NINJA 250SL	15' - 16'	HYPERNAKED	RIGHT	9975N		(*)	
NINJA 250SL	15' - 16'	HYPERNAKED	LEFT	9975N		(*)	
NINJA 250SL	15' - 16'	EXPLORER	RIGHT	9975N		(*)	
NINJA 250SL	15' - 16'	EXPLORER	LEFT	9975N		(*)	
NINJA 250SL	15' - 16'	GTI	RIGHT	9975N		(*)	
NINJA 250SL	15' - 16'	GTI	LEFT	9975N		(*)	
NINJA 250SL	15' - 16'	RETRO	RIGHT	9975N		(*)	
NINJA 250SL	15' - 16'	RETRO	LEFT	9975N		(*)	
NINJA 250SL	15' - 16'	RS1	RIGHT		7346	(*)	(*)

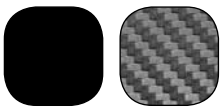

N
Black

C
Carbon Look

(*) Check price with your distributor.

IMPORTANT: Indicate code color after part#. Example: 0973A.

ADAPTORS TO ATTACH TO THE FAIRING

HI-TECH PARTS | TYPE OF REAR MIRROR:

2019
MODELS:
www.puig.tv



MODEL	YEAR	TYPE OF REAR MIRROR	SIDE	REF. ADAPTOR	REF. REAR MIRROR	N	C
NINJA 250SL	15' - 16'	RS1	LEFT		7347	(*)	(*)
NINJA 250SL	15' - 16'	RS2	RIGHT		7354	(*)	(*)
NINJA 250SL	15' - 16'	RS2	LEFT		7355	(*)	(*)
NINJA 300	13' - 17'	HI-TECH I	RIGHT	9276N		(*)	
NINJA 300	13' - 17'	HI-TECH I	LEFT	9276N		(*)	
NINJA 300	13' - 17'	HI-TECH II	RIGHT	9276N		(*)	
NINJA 300	13' - 17'	HI-TECH II	LEFT	9276N		(*)	
NINJA 300	13' - 17'	HI-TECH III	RIGHT	9276N		(*)	
NINJA 300	13' - 17'	HI-TECH III	LEFT	9276N		(*)	
NINJA 300	13' - 17'	GT	RIGHT	9276N		(*)	
NINJA 300	13' - 17'	GT	LEFT	9276N		(*)	
NINJA 300	13' - 17'	F1	RIGHT	9276N		(*)	
NINJA 300	13' - 17'	F1	LEFT	9276N		(*)	
NINJA 300	13' - 17'	HYPERNAKED	RIGHT	9276N		(*)	
NINJA 300	13' - 17'	HYPERNAKED	LEFT	9276N		(*)	
NINJA 300	13' - 17'	EXPLORER	RIGHT	9276N		(*)	
NINJA 300	13' - 17'	EXPLORER	LEFT	9276N		(*)	
NINJA 300	13' - 17'	GTI	RIGHT	9276N		(*)	
NINJA 300	13' - 17'	GTI	LEFT	9276N		(*)	
NINJA 300	13' - 17'	RETRO	RIGHT	9276N		(*)	
NINJA 300	13' - 17'	RETRO	LEFT	9276N		(*)	
NINJA 300	13' - 17'	RS1	RIGHT		7346	(*)	(*)
NINJA 300	13' - 17'	RS1	LEFT		7347	(*)	(*)
NINJA 300	13' - 17'	RS2	RIGHT		7354	(*)	(*)
NINJA 300	13' - 17'	RS2	LEFT		7355	(*)	(*)
NINJA 400	18'	HI-TECH I	RIGHT	9975N		(*)	
NINJA 400	18'	HI-TECH I	LEFT	9975N		(*)	
NINJA 400	18'	HI-TECH II	RIGHT	9975N		(*)	
NINJA 400	18'	HI-TECH II	LEFT	9975N		(*)	
NINJA 400	18'	HI-TECH III	RIGHT	9975N		(*)	
NINJA 400	18'	HI-TECH III	LEFT	9975N		(*)	
NINJA 400	18'	GT	RIGHT	9975N		(*)	
NINJA 400	18'	GT	LEFT	9975N		(*)	
NINJA 400	18'	F1	RIGHT	9975N		(*)	
NINJA 400	18'	F1	LEFT	9975N		(*)	
NINJA 400	18'	HYPERNAKED	RIGHT	9975N		(*)	
NINJA 400	18'	HYPERNAKED	LEFT	9975N		(*)	
NINJA 400	18'	EXPLORER	RIGHT	9975N		(*)	
NINJA 400	18'	EXPLORER	LEFT	9975N		(*)	
NINJA 400	18'	GTI	RIGHT	9975N		(*)	

MODEL	YEAR	TYPE OF REAR MIRROR	SIDE	REF. ADAPTOR	REF. REAR MIRROR	N	C
NINJA 400	18'	GTI	LEFT	9975N		(*)	
NINJA 400	18'	RETRO	RIGHT	9975N		(*)	
NINJA 400	18'	RETRO	LEFT	9975N		(*)	
NINJA 400	18'	RS1	RIGHT		7346	(*)	(*)
NINJA 400	18'	RS1	LEFT		7347	(*)	(*)
NINJA 400	18'	RS2	RIGHT		7354	(*)	(*)
NINJA 400	18'	RS2	LEFT		7355	(*)	(*)
NINJA 650	17' - 18'	HI-TECH I	RIGHT	9276N		(*)	
NINJA 650	17' - 18'	HI-TECH I	LEFT	9276N		(*)	
NINJA 650	17' - 18'	HI-TECH II	RIGHT	9276N		(*)	
NINJA 650	17' - 18'	HI-TECH II	LEFT	9276N		(*)	
NINJA 650	17' - 18'	HI-TECH III	RIGHT	9276N		(*)	
NINJA 650	17' - 18'	HI-TECH III	LEFT	9276N		(*)	
NINJA 650	17' - 18'	GT	RIGHT	9276N		(*)	
NINJA 650	17' - 18'	GT	LEFT	9276N		(*)	
NINJA 650	17' - 18'	F1	RIGHT	9276N		(*)	
NINJA 650	17' - 18'	F1	LEFT	9276N		(*)	
NINJA 650	17' - 18'	HYPERNAKED	RIGHT	9276N		(*)	
NINJA 650	17' - 18'	HYPERNAKED	LEFT	9276N		(*)	
NINJA 650	17' - 18'	EXPLORER	RIGHT	9276N		(*)	
NINJA 650	17' - 18'	EXPLORER	LEFT	9276N		(*)	
NINJA 650	17' - 18'	GTI	RIGHT	9276N		(*)	
NINJA 650	17' - 18'	GTI	LEFT	9276N		(*)	
NINJA 650	17' - 18'	RETRO	RIGHT	9276N		(*)	
NINJA 650	17' - 18'	RETRO	LEFT	9276N		(*)	
NINJA 650	17' - 18'	RS1	RIGHT		7342	(*)	(*)
NINJA 650	17' - 18'	RS1	LEFT		7343	(*)	
NINJA 650	17' - 18'	RS2	RIGHT		7350	(*)	(*)
NINJA 650	17' - 18'	RS2	LEFT		7351	(*)	(*)
Z750S	05' - 06'	RS1	RIGHT		7344	(*)	(*)
Z750S	05' - 06'	RS1	LEFT		7345	(*)	(*)
Z750S	05' - 06'	RS2	RIGHT		7352	(*)	(*)
Z750S	05' - 06'	RS2	LEFT		7353	(*)	(*)
Z1000SX	17' -18'	HI-TECH I	RIGHT	9406N		(*)	
Z1000SX	17' -18'	HI-TECH I	LEFT	9406N		(*)	
Z1000SX	17' -18'	HI-TECH II	RIGHT	9406N		(*)	
Z1000SX	17' -18'	HI-TECH II	LEFT	9406N		(*)	
Z1000SX	17' -18'	HI-TECH III	RIGHT	9406N		(*)	
Z1000SX	17' -18'	HI-TECH III	LEFT	9406N		(*)	
Z1000SX	17' -18'	GT	RIGHT	9406N		(*)	
Z1000SX	17' -18'	GT	LEFT	9406N		(*)	
Z1000SX	17' -18'	F1	RIGHT	9406N		(*)	
Z1000SX	17' -18'	F1	LEFT	9406N		(*)	



N
Black



C
Carbon Look

(*) Check price with your distributor.

IMPORTANT: Indicate code color after part#. Example: 0973A.

ADAPTORS TO ATTACH TO THE FAIRING

HI-TECH PARTS | TYPE OF REAR MIRROR:

2019
MODELS:
www.puig.tv



MODEL	YEAR	TYPE OF REAR MIRROR	SIDE	REF. ADAPTOR	REF. REAR MIRROR	N	C
Z1000SX	17' -18'	HYPERNAKED	RIGHT	9406N		(*)	
Z1000SX	17' -18'	HYPERNAKED	LEFT	9406N		(*)	
Z1000SX	17' -18'	EXPLORER	RIGHT	9406N		(*)	
Z1000SX	17' -18'	EXPLORER	LEFT	9406N		(*)	
Z1000SX	17' -18'	GTI	RIGHT	9406N		(*)	
Z1000SX	17' -18'	GTI	LEFT	9406N		(*)	
Z1000SX	17' -18'	RETRO	RIGHT	9406N		(*)	
Z1000SX	17' -18'	RETRO	LEFT	9406N		(*)	
Z1000SX	11' - 18'	RS1	RIGHT		7342	(*)	(*)
Z1000SX	11' - 18'	RS1	LEFT		7343	(*)	
Z1000SX	11' - 18'	RS2	RIGHT		7350	(*)	(*)
Z1000SX	11' - 18'	RS2	LEFT		7351	(*)	(*)
ZX-6R	09' - 16'	RS1	RIGHT		7342	(*)	(*)
ZX-6R	09' - 16'	RS1	LEFT		7343	(*)	
ZX-6R	09' - 16'	RS2	RIGHT		7350	(*)	(*)
ZX-6R	09' - 16'	RS2	LEFT		7351	(*)	(*)
ZX-6R 636	13' - 16'	HI-TECH I	RIGHT	9276N		(*)	
ZX-6R 636	13' - 16'	HI-TECH I	LEFT	9276N		(*)	
ZX-6R 636	13' - 16'	HI-TECH II	RIGHT	9276N		(*)	
ZX-6R 636	13' - 16'	HI-TECH II	LEFT	9276N		(*)	
ZX-6R 636	13' - 16'	HI-TECH III	RIGHT	9276N		(*)	
ZX-6R 636	13' - 16'	HI-TECH III	LEFT	9276N		(*)	
ZX-6R 636	13' - 16'	GT	RIGHT	9276N		(*)	
ZX-6R 636	13' - 16'	GT	LEFT	9276N		(*)	
ZX-6R 636	13' - 16'	F1	RIGHT	9276N		(*)	
ZX-6R 636	13' - 16'	F1	LEFT	9276N		(*)	
ZX-6R 636	13' - 16'	HYPERNAKED	RIGHT	9276N		(*)	
ZX-6R 636	13' - 16'	HYPERNAKED	LEFT	9276N		(*)	
ZX-6R 636	13' - 16'	EXPLORER	RIGHT	9276N		(*)	
ZX-6R 636	13' - 16'	EXPLORER	LEFT	9276N		(*)	
ZX-6R 636	13' - 16'	GTI	RIGHT	9276N		(*)	
ZX-6R 636	13' - 16'	GTI	LEFT	9276N		(*)	
ZX-6R 636	13' - 16'	RETRO	RIGHT	9276N		(*)	
ZX-6R 636	13' - 16'	RETRO	LEFT	9276N		(*)	
ZX-6R 636	13' - 16'	RS1	RIGHT		7342	(*)	(*)
ZX-6R 636	13' - 16'	RS1	LEFT		7343	(*)	
ZX-6R 636	13' - 16'	RS2	RIGHT		7350	(*)	(*)
ZX-6R 636	13' - 16'	RS2	LEFT		7351	(*)	(*)
ZX-10R	04' - 18'	RS1	RIGHT		7346	(*)	(*)
ZX-10R	04' - 18'	RS1	LEFT		7347	(*)	(*)

MODEL	YEAR	TYPE OF REAR MIRROR	SIDE	REF. ADAPTOR	REF. REAR MIRROR	N	C
ZX-10R	04' - 18'	RS2	RIGHT		7354	(*)	(*)
ZX-10R	04' - 18'	RS2	LEFT		7355	(*)	(*)
ZX-10RR	17' - 18'	RS1	RIGHT		7346	(*)	(*)
ZX-10RR	17' - 18'	RS1	LEFT		7347	(*)	(*)
ZX-10RR	17' - 18'	RS2	RIGHT		7354	(*)	(*)
ZX-10RR	17' - 18'	RS2	LEFT		7355	(*)	(*)
ZX-12R	00' - 06'	RS1	RIGHT		7342	(*)	(*)
ZX-12R	00' - 06'	RS1	LEFT		7343	(*)	
ZX-12R	00' - 06'	RS2	RIGHT		7350	(*)	(*)
ZX-12R	00' - 06'	RS2	LEFT		7351	(*)	(*)
KYMCO							
AK 550	17' - 18'	HI-TECH I	RIGHT	9548N		(*)	
AK 550	17' - 18'	HI-TECH I	LEFT	9549N		(*)	
AK 550	17' - 18'	HI-TECH II	RIGHT	9548N		(*)	
AK 550	17' - 18'	HI-TECH II	LEFT	9549N		(*)	
AK 550	17' - 18'	HI-TECH III	RIGHT	9548N		(*)	
AK 550	17' - 18'	HI-TECH III	LEFT	9549N		(*)	
AK 550	17' - 18'	GT	RIGHT	9548N		(*)	
AK 550	17' - 18'	GT	LEFT	9549N		(*)	
AK 550	17' - 18'	F1	RIGHT	9548N		(*)	
AK 550	17' - 18'	F1	LEFT	9549N		(*)	
AK 550	17' - 18'	HYPERNAKED	RIGHT	9548N		(*)	
AK 550	17' - 18'	HYPERNAKED	LEFT	9549N		(*)	
AK 550	17' - 18'	EXPLORER	RIGHT	9548N		(*)	
AK 550	17' - 18'	EXPLORER	LEFT	9549N		(*)	
AK 550	17' - 18'	GTI	RIGHT	9548N		(*)	
AK 550	17' - 18'	GTI	LEFT	9549N		(*)	
AK 550	17' - 18'	RETRO	RIGHT	9548N		(*)	
AK 550	17' - 18'	RETRO	LEFT	9549N		(*)	
SUZUKI							
GS500F	04' - 07'	RS1	RIGHT		7344	(*)	(*)
GS500F	04' - 07'	RS1	LEFT		7345	(*)	(*)
GS500F	04' - 07'	RS2	RIGHT		7352	(*)	(*)
GS500F	04' - 07'	RS2	LEFT		7353	(*)	(*)
GSF650S BANDIT	05' - 14'	RS1	RIGHT		7344	(*)	(*)
GSF650S BANDIT	05' - 14'	RS1	LEFT		7345	(*)	(*)
GSF650S BANDIT	05' - 14'	RS2	RIGHT		7352	(*)	(*)
GSF650S BANDIT	05' - 14'	RS2	LEFT		7353	(*)	(*)
GSF1200S BANDIT	96' - 06'	RS1	RIGHT		7344	(*)	(*)
GSF1200S BANDIT	96' - 06'	RS1	LEFT		7345	(*)	(*)
GSF1200S BANDIT	96' - 06'	RS2	RIGHT		7352	(*)	(*)
GSF1200S BANDIT	96' - 06'	RS2	LEFT		7353	(*)	(*)
GSF1250 BANDIT	10' - 13'	RS2	RIGHT		7352	(*)	(*)



N
Black



C
Carbon Look

(*) Check price with your distributor.

IMPORTANT: Indicate code color after part#. Example: 0973A.

ADAPTORS TO ATTACH TO THE FAIRING

HI-TECH PARTS | TYPE OF REAR MIRROR:

2019
MODELS:
www.puig.tv



MODEL	YEAR	TYPE OF REAR MIRROR	SIDE	REF. ADAPTOR	REF. REAR MIRROR	N	C
GSF1250 BANDIT	10' - 13'	RS2	LEFT		7353	(*)	(*)
GSF1250S BANDIT	07' - 17'	RS1	RIGHT		7344	(*)	(*)
GSF1250S BANDIT	07' - 17'	RS1	LEFT		7345	(*)	(*)
GSF1250S BANDIT	07' - 17'	RS2	RIGHT		7352	(*)	(*)
GSF1250S BANDIT	07' - 17'	RS2	LEFT		7353	(*)	(*)
GSX650F	08' - 17'	RS1	RIGHT		7344	(*)	(*)
GSX650F	08' - 17'	RS1	LEFT		7345	(*)	(*)
GSX650F	08' - 17'	RS2	RIGHT		7352	(*)	(*)
GSX650F	08' - 17'	RS2	LEFT		7353	(*)	(*)
GSX1250F	10' - 17'	RS1	RIGHT		7344	(*)	(*)
GSX1250F	10' - 17'	RS1	LEFT		7345	(*)	(*)
GSX1250F	10' - 17'	RS2	RIGHT		7352	(*)	(*)
GSX1250F	10' - 17'	RS2	LEFT		7353	(*)	(*)
GSX-R125	17' - 18'	HI-TECH I	RIGHT	9525N		(*)	
GSX-R125	17' - 18'	HI-TECH I	LEFT	9526N		(*)	
GSX-R125	17' - 18'	HI-TECH II	RIGHT	9525N		(*)	
GSX-R125	17' - 18'	HI-TECH II	LEFT	9526N		(*)	
GSX-R125	17' - 18'	HI-TECH III	RIGHT	9525N		(*)	
GSX-R125	17' - 18'	HI-TECH III	LEFT	9526N		(*)	
GSX-R125	17' - 18'	GT	RIGHT	9525N		(*)	
GSX-R125	17' - 18'	GT	LEFT	9526N		(*)	
GSX-R125	17' - 18'	F1	RIGHT	9525N		(*)	
GSX-R125	17' - 18'	F1	LEFT	9526N		(*)	
GSX-R125	17' - 18'	HYPERNAKED	RIGHT	9525N		(*)	
GSX-R125	17' - 18'	HYPERNAKED	LEFT	9526N		(*)	
GSX-R125	17' - 18'	EXPLORER	RIGHT	9525N		(*)	
GSX-R125	17' - 18'	EXPLORER	LEFT	9526N		(*)	
GSX-R125	17' - 18'	GTI	RIGHT	9525N		(*)	
GSX-R125	17' - 18'	GTI	LEFT	9526N		(*)	
GSX-R125	17' - 18'	RETRO	RIGHT	9525N		(*)	
GSX-R125	17' - 18'	RETRO	LEFT	9526N		(*)	
GSX-R125	17' - 18'	RS1	RIGHT		7342	(*)	(*)
GSX-R125	17' - 18'	RS1	LEFT		7343	(*)	
GSX-R125	17' - 18'	RS2	RIGHT		7350	(*)	(*)
GSX-R125	17' - 18'	RS2	LEFT		7351	(*)	(*)
GSX-R250	17' - 18'	HI-TECH I	RIGHT	9525N		(*)	
GSX-R250	17' - 18'	HI-TECH I	LEFT	9526N		(*)	
GSX-R250	17' - 18'	HI-TECH II	RIGHT	9525N		(*)	
GSX-R250	17' - 18'	HI-TECH II	LEFT	9526N		(*)	
GSX-R250	17' - 18'	HI-TECH III	RIGHT	9525N		(*)	

MODEL	YEAR	TYPE OF REAR MIRROR	SIDE	REF. ADAPTOR	REF. REAR MIRROR	N	C
GSX-R250	17' - 18'	HI-TECH III	LEFT	9526N		(*)	
GSX-R250	17' - 18'	GT	RIGHT	9525N		(*)	
GSX-R250	17' - 18'	GT	LEFT	9526N		(*)	
GSX-R250	17' - 18'	F1	RIGHT	9525N		(*)	
GSX-R250	17' - 18'	F1	LEFT	9526N		(*)	
GSX-R250	17' - 18'	HYPERNAKED	RIGHT	9525N		(*)	
GSX-R250	17' - 18'	HYPERNAKED	LEFT	9526N		(*)	
GSX-R250	17' - 18'	EXPLORER	RIGHT	9525N		(*)	
GSX-R250	17' - 18'	EXPLORER	LEFT	9526N		(*)	
GSX-R250	17' - 18'	GTI	RIGHT	9525N		(*)	
GSX-R250	17' - 18'	GTI	LEFT	9526N		(*)	
GSX-R250	17' - 18'	RETRO	RIGHT	9525N		(*)	
GSX-R250	17' - 18'	RETRO	LEFT	9526N		(*)	
GSX-R250	17' -18'	RS1	RIGHT		7342	(*)	(*)
GSX-R250	17' -18'	RS1	LEFT		7343	(*)	
GSX-R250	17' -18'	RS2	RIGHT		7350	(*)	(*)
GSX-R250	17' -18'	RS2	LEFT		7351	(*)	(*)
GSX-R600/750	04' -17'	RS1	RIGHT		7342	(*)	(*)
GSX-R600/750	04' -17'	RS1	LEFT		7343	(*)	
GSX-R600/750	04' -17'	RS2	RIGHT		7350	(*)	(*)
GSX-R600/750	04' -17'	RS2	LEFT		7351	(*)	(*)
GSX-R1000	01' - 16'	RS1	RIGHT		7346	(*)	(*)
GSX-R1000	01' - 16'	RS1	LEFT		7347	(*)	(*)
GSX-R1000	01' - 16'	RS2	RIGHT		7354	(*)	(*)
GSX-R1000	01' - 16'	RS2	LEFT		7355	(*)	(*)
GSX-R1000/R	17' - 18'	HI-TECH I	RIGHT	9454N		(*)	
GSX-R1000/R	17' - 18'	HI-TECH I	LEFT	9472N		(*)	
GSX-R1000/R	17' - 18'	HI-TECH II	RIGHT	9454N		(*)	
GSX-R1000/R	17' - 18'	HI-TECH II	LEFT	9472N		(*)	
GSX-R1000/R	17' - 18'	HI-TECH III	RIGHT	9454N		(*)	
GSX-R1000/R	17' - 18'	HI-TECH III	LEFT	9472N		(*)	
GSX-R1000/R	17' - 18'	GT	RIGHT	9454N		(*)	
GSX-R1000/R	17' - 18'	GT	LEFT	9472N		(*)	
GSX-R1000/R	17' - 18'	F1	RIGHT	9454N		(*)	
GSX-R1000/R	17' - 18'	F1	LEFT	9472N		(*)	
GSX-R1000/R	17' - 18'	HYPERNAKED	LEFT	9472N		(*)	
GSX-R1000/R	17' - 18'	HYPERNAKED	RIGHT	9454N		(*)	
GSX-R1000/R	17' - 18'	EXPLORER	LEFT	9472N		(*)	
GSX-R1000/R	17' - 18'	EXPLORER	RIGHT	9454N		(*)	
GSX-R1000/R	17' - 18'	GTI	RIGHT	9472N		(*)	
GSX-R1000/R	17' - 18'	GTI	LEFT	9454N		(*)	
GSX-R1000/R	17' - 18'	RETRO	RIGHT	9472N		(*)	
GSX-R1000/R	17' - 18'	RETRO	LEFT	9454N		(*)	

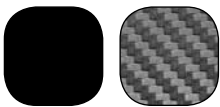

N
Black

C
Carbon Look

(*) Check price with your distributor.

IMPORTANT: Indicate code color after part#. Example: 0973A.

ADAPTORS TO ATTACH TO THE FAIRING

HI-TECH PARTS | TYPE OF REAR MIRROR:

2019
MODELS:
www.puig.tv



MODEL	YEAR	TYPE OF REAR MIRROR	SIDE	REF. ADAPTOR	REF. REAR MIRROR	N	C
GSX-R1000/R	17' - 18'	RS1	RIGHT		7346	(*)	(*)
GSX-R1000/R	17' - 18'	RS1	LEFT		7347	(*)	(*)
GSX-R1000/R	17' - 18'	RS2	RIGHT		7354	(*)	(*)
GSX-R1000/R	17' - 18'	RS2	LEFT		7355	(*)	(*)
SV650/1000S	99' - 05'	RS1	RIGHT		7344	(*)	(*)
SV650/1000S	99' - 05'	RS1	LEFT		7345	(*)	(*)
SV650/1000S	99' - 05'	RS2	RIGHT		7352	(*)	(*)
SV650/1000S	99' - 05'	RS2	LEFT		7353	(*)	(*)
TRIUMPH							
DAYTONA 600	03' - 04'	RS1	RIGHT		7342	(*)	(*)
DAYTONA 600	03' - 04'	RS1	LEFT		7343	(*)	
DAYTONA 600	03' - 04'	RS2	RIGHT		7350	(*)	(*)
DAYTONA 600	03' - 04'	RS2	LEFT		7351	(*)	(*)
DAYTONA 650	05'	RS1	RIGHT		7342	(*)	(*)
DAYTONA 650	05'	RS1	LEFT		7343	(*)	
DAYTONA 650	05'	RS2	RIGHT		7350	(*)	(*)
DAYTONA 650	05'	RS2	LEFT		7351	(*)	(*)
DAYTONA 675	06' - 16'	RS1	RIGHT		7342	(*)	(*)
DAYTONA 675	06' - 16'	RS1	LEFT		7343	(*)	
DAYTONA 675	06' - 16'	RS2	RIGHT		7350	(*)	(*)
DAYTONA 675	06' - 16'	RS2	LEFT		7351	(*)	(*)
DAYTONA 675 R	11' - 16'	RS1	RIGHT		7342	(*)	(*)
DAYTONA 675 R	11' - 16'	RS1	LEFT		7343	(*)	
DAYTONA 675 R	11' - 16'	RS2	RIGHT		7350	(*)	(*)
DAYTONA 675 R	11' - 16'	RS2	LEFT		7351	(*)	(*)
DAYTONA 675/R	13' - 16'	HI-TECH I	RIGHT	9571N		(*)	
DAYTONA 675/R	13' - 16'	HI-TECH I	LEFT	9572N		(*)	
DAYTONA 675/R	13' - 16'	HI-TECH II	RIGHT	9571N		(*)	
DAYTONA 675/R	13' - 16'	HI-TECH II	LEFT	9572N		(*)	
DAYTONA 675/R	13' - 16'	HI-TECH III	RIGHT	9571N		(*)	
DAYTONA 675/R	13' - 16'	HI-TECH III	LEFT	9572N		(*)	
DAYTONA 675/R	13' - 16'	GT	RIGHT	9571N		(*)	
DAYTONA 675/R	13' - 16'	GT	LEFT	9572N		(*)	
DAYTONA 675/R	13' - 16'	F1	RIGHT	9571N		(*)	
DAYTONA 675/R	13' - 16'	F1	LEFT	9572N		(*)	
DAYTONA 675/R	13' - 16'	HYPERNAKED	RIGHT	9571N		(*)	
DAYTONA 675/R	13' - 16'	HYPERNAKED	LEFT	9572N		(*)	
DAYTONA 675/R	13' - 16'	EXPLORER	RIGHT	9571N		(*)	
DAYTONA 675/R	13' - 16'	EXPLORER	LEFT	9572N		(*)	
DAYTONA 675/R	13' - 16'	GTI	RIGHT	9571N		(*)	

MODEL	YEAR	TYPE OF REAR MIRROR	SIDE	REF. ADAPTOR	REF. REAR MIRROR	N	C
DAYTONA 675/R	13' - 16'	GTI	LEFT	9572N		(*)	
DAYTONA 675/R	13' - 16'	RETRO	RIGHT	9571N		(*)	
DAYTONA 675/R	13' - 16'	RETRO	LEFT	9572N		(*)	
DAYTONA 955i	01' - 03'	RS1	RIGHT		7342	(*)	(*)
DAYTONA 955i	01' - 03'	RS1	LEFT		7343	(*)	
DAYTONA 955i	01' - 03'	RS2	RIGHT		7350	(*)	(*)
DAYTONA 955i	01' - 03'	RS2	LEFT		7351	(*)	(*)
YAMAHA							
FZ1 FAZER	06' - 15'	RS1	RIGHT		7346	(*)	(*)
FZ1 FAZER	06' - 15'	RS1	LEFT		7347	(*)	(*)
FZ1 FAZER	06' - 15'	RS2	RIGHT		7354	(*)	(*)
FZ1 FAZER	06' - 15'	RS2	LEFT		7355	(*)	(*)
FZ6 FAZER	04' - 08'	RS1	RIGHT		7342	(*)	(*)
FZ6 FAZER	04' - 08'	RS1	LEFT		7343	(*)	
FZ6 FAZER	04' - 08'	RS2	RIGHT		7350	(*)	(*)
FZ6 FAZER	04' - 08'	RS2	LEFT		7351	(*)	(*)
FZ6 FAZER S2	07' - 10'	RS1	RIGHT		7342	(*)	(*)
FZ6 FAZER S2	07' - 10'	RS1	LEFT		7343	(*)	
FZ6 FAZER S2	07' - 10'	RS2	RIGHT		7350	(*)	(*)
FZ6 FAZER S2	07' - 10'	RS2	LEFT		7351	(*)	(*)
FZ8 FAZER	10' - 12'	RS1	RIGHT		7342	(*)	(*)
FZ8 FAZER	10' - 12'	RS1	LEFT		7343	(*)	
FZ8 FAZER	10' - 12'	RS2	RIGHT		7350	(*)	(*)
FZ8 FAZER	10' - 12'	RS2	LEFT		7351	(*)	(*)
FAZER8	13' - 16'	RS1	RIGHT		7346	(*)	(*)
FAZER8	13' - 16'	RS1	LEFT		7347	(*)	(*)
FAZER8	13' - 16'	RS2	RIGHT		7354	(*)	(*)
FAZER8	13' - 16'	RS2	LEFT		7355	(*)	(*)
SCR950	17' - 18'	RS1	RIGHT		7346	(*)	(*)
SCR950	17' - 18'	RS1	LEFT		7347	(*)	(*)
SCR950	17' - 18'	RS2	RIGHT		7354	(*)	(*)
SCR950	17' - 18'	RS2	LEFT		7355	(*)	(*)
TZR50	98' - 16'	RS1	RIGHT		7344	(*)	(*)
TZR50	98' - 16'	RS1	LEFT		7345	(*)	(*)
TZR50	98' - 16'	RS2	RIGHT		7352	(*)	(*)
TZR50	98' - 16'	RS2	LEFT		7353	(*)	(*)
XJ6 DIVERSION	09' - 16'	HI-TECH I	RIGHT	9577N		(*)	
XJ6 DIVERSION	09' - 16'	HI-TECH I	LEFT	9577N		(*)	
XJ6 DIVERSION	09' - 16'	HI-TECH II	RIGHT	9577N		(*)	
XJ6 DIVERSION	09' - 16'	HI-TECH II	LEFT	9577N		(*)	
XJ6 DIVERSION	09' - 16'	HI-TECH III	RIGHT	9577N		(*)	
XJ6 DIVERSION	09' - 16'	HI-TECH III	LEFT	9577N		(*)	
XJ6 DIVERSION	09' - 16'	GT	RIGHT	9577N		(*)	

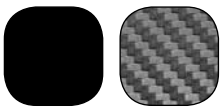

N
Black

C
Carbon Look

(*) Check price with your distributor.

IMPORTANT: Indicate code color after part#. Example: 0973A.

ADAPTORS TO ATTACH TO THE FAIRING

HI-TECH PARTS | TYPE OF REAR MIRROR:

2019
MODELS:
www.puig.tv



MODEL	YEAR	TYPE OF REAR MIRROR	SIDE	REF. ADAPTOR	REF. REAR MIRROR	N	C
XJ6 DIVERSION	09' - 16'	GT	LEFT	9577N		(*)	
XJ6 DIVERSION	09' - 16'	F1	RIGHT	9577N		(*)	
XJ6 DIVERSION	09' - 16'	F1	LEFT	9577N		(*)	
XJ6 DIVERSION	09' - 16'	HYPERNAKED	RIGHT	9577N		(*)	
XJ6 DIVERSION	09' - 16'	HYPERNAKED	LEFT	9577N		(*)	
XJ6 DIVERSION	09' - 16'	EXPLORER	RIGHT	9577N		(*)	
XJ6 DIVERSION	09' - 16'	EXPLORER	LEFT	9577N		(*)	
XJ6 DIVERSION	09' - 16'	GTI	RIGHT	9577N		(*)	
XJ6 DIVERSION	09' - 16'	GTI	LEFT	9577N		(*)	
XJ6 DIVERSION	09' - 16'	RETRO	RIGHT	9577N		(*)	
XJ6 DIVERSION	09' - 16'	RETRO	LEFT	9577N		(*)	
XJ6 DIVERSION F	10' - 16'	RS1	RIGHT		7346	(*)	(*)
XJ6 DIVERSION F	10' - 16'	RS1	LEFT		7347	(*)	(*)
XJ6 DIVERSION F	10' - 16'	RS2	RIGHT		7354	(*)	(*)
XJ6 DIVERSION F	10' - 16'	RS2	LEFT		7355	(*)	(*)
T-MAX 530	12' - 16'	HI-TECH I TO FAIRING	RIGHT	9574N		(*)	
T-MAX 530	12' - 16'	HI-TECH I TO FAIRING	LEFT	9573N		(*)	
T-MAX 530	12' - 16'	HI-TECH II TO FAIRING	RIGHT	9574N		(*)	
T-MAX 530	12' - 16'	HI-TECH II TO FAIRING	LEFT	9573N		(*)	
T-MAX 530	12' - 16'	HI-TECH III TO FAIRING	RIGHT	9574N		(*)	
T-MAX 530	12' - 16'	HI-TECH III TO FAIRING	LEFT	9573N		(*)	
T-MAX 530	12' - 16'	GT TO FAIRING	RIGHT	9574N		(*)	
T-MAX 530	12' - 16'	GT TO FAIRING	LEFT	9573N		(*)	
T-MAX 530	12' - 16'	F1 TO FAIRING	RIGHT	9574N		(*)	
T-MAX 530	12' - 16'	F1 TO FAIRING	LEFT	9573N		(*)	
T-MAX 530	12' - 16'	HYPERNAKED TO FAIRING	RIGHT	9574N		(*)	
T-MAX 530	12' - 16'	HYPERNAKED TO FAIRING	LEFT	9573N		(*)	
T-MAX 530	12' - 16'	EXPLORER TO FAIRING	RIGHT	9574N		(*)	
T-MAX 530	12' - 16'	EXPLORER TO FAIRING	LEFT	9573N		(*)	
T-MAX 530	12' - 16'	GTI	RIGHT	9574N		(*)	
T-MAX 530	12' - 16'	GTI	LEFT	9573N		(*)	
T-MAX 530	12' - 16'	RETRO	RIGHT	9574N		(*)	
T-MAX 530	12' - 16'	RETRO	LEFT	9573N		(*)	
T-MAX 530/DX/SX	17' - 18'	HI-TECH I TO FAIRING	RIGHT	9574N		(*)	
T-MAX 530/DX/SX	17' - 18'	HI-TECH I TO FAIRING	LEFT	9573N		(*)	
T-MAX 530/DX/SX	17' - 18'	HI-TECH II TO FAIRING	RIGHT	9574N		(*)	
T-MAX 530/DX/SX	17' - 18'	HI-TECH II TO FAIRING	LEFT	9573N		(*)	
T-MAX 530/DX/SX	17' - 18'	HI-TECH III TO FAIRING	RIGHT	9574N		(*)	
T-MAX 530/DX/SX	17' - 18'	HI-TECH III TO FAIRING	LEFT	9573N		(*)	
T-MAX 530/DX/SX	17' - 18'	GT TO FAIRING	RIGHT	9574N		(*)	

MODEL	YEAR	TYPE OF REAR MIRROR	SIDE	REF. ADAPTOR	REF. REAR MIRROR	N	C
T-MAX 530/DX/SX	17' - 18'	GT TO FAIRING	LEFT	9573N		(*)	
T-MAX 530/DX/SX	17' - 18'	F1 TO FAIRING	RIGHT	9574N		(*)	
T-MAX 530/DX/SX	17' - 18'	F1 TO FAIRING	LEFT	9573N		(*)	
T-MAX 530/DX/SX	17' - 18'	HYPERNAKED TO FAIRING	RIGHT	9574N		(*)	
T-MAX 530/DX/SX	17' - 18'	HYPERNAKED TO FAIRING	LEFT	9573N		(*)	
T-MAX 530/DX/SX	17' - 18'	EXPLORER TO FAIRING	RIGHT	9574N		(*)	
T-MAX 530/DX/SX	17' - 18'	EXPLORER TO FAIRING	LEFT	9573N		(*)	
T-MAX 530/DX/SX	17' - 18'	GTI	RIGHT	9574N		(*)	
T-MAX 530/DX/SX	17' - 18'	GTI	LEFT	9573N		(*)	
T-MAX 530/DX/SX	17' - 18'	RETRO	RIGHT	9574N		(*)	
T-MAX 530/DX/SX	17' - 18'	RETRO	LEFT	9573N		(*)	
YZF-R 125	08' - 18'	RS1	RIGHT		7342	(*)	(*)
YZF-R 125	08' - 18'	RS1	LEFT		7343	(*)	
YZF-R 125	08' - 18'	RS2	RIGHT		7350	(*)	(*)
YZF-R 125	08' - 18'	RS2	LEFT		7351	(*)	(*)
YZF-R1	98' - 03'	RS1	RIGHT		7342	(*)	(*)
YZF-R1	98' - 03'	RS1	LEFT		7343	(*)	
YZF-R1	98' - 03'	RS2	RIGHT		7350	(*)	(*)
YZF-R1	98' - 03'	RS2	LEFT		7351	(*)	(*)
YZF-R1	09' - 14'	HI-TECH I	RIGHT	9577N		(*)	
YZF-R1	09' - 14'	HI-TECH I	LEFT	9577N		(*)	
YZF-R1	09' - 14'	HI-TECH II	RIGHT	9577N		(*)	
YZF-R1	09' - 14'	HI-TECH II	LEFT	9577N		(*)	
YZF-R1	09' - 14'	HI-TECH III	RIGHT	9577N		(*)	
YZF-R1	09' - 14'	HI-TECH III	LEFT	9577N		(*)	
YZF-R1	09' - 14'	GT	RIGHT	9577N		(*)	
YZF-R1	09' - 14'	GT	LEFT	9577N		(*)	
YZF-R1	09' - 14'	F1	RIGHT	9577N		(*)	
YZF-R1	09' - 14'	F1	LEFT	9577N		(*)	
YZF-R1	09' - 14'	HYPERNAKED	RIGHT	9577N		(*)	
YZF-R1	09' - 14'	HYPERNAKED	LEFT	9577N		(*)	
YZF-R1	09' - 14'	EXPLORER	RIGHT	9577N		(*)	
YZF-R1	09' - 14'	EXPLORER	LEFT	9577N		(*)	
YZF-R1	09' - 14'	GTI	RIGHT	9577N		(*)	
YZF-R1	09' - 14'	GTI	LEFT	9577N		(*)	
YZF-R1	09' - 14'	RETRO	RIGHT	9577N		(*)	
YZF-R1	09' - 14'	RETRO	LEFT	9577N		(*)	
YZF-R1	04' - 14'	RS1	RIGHT		7346	(*)	(*)
YZF-R1	04' - 14'	RS1	LEFT		7347	(*)	(*)
YZF-R1	04' - 14'	RS2	RIGHT		7354	(*)	(*)
YZF-R1	04' - 14'	RS2	LEFT		7355	(*)	(*)
YZF-R1	15' - 18'	RS1	RIGHT		7342	(*)	(*)
YZF-R1	15' - 18'	RS1	LEFT		7343	(*)	



N
Black



C
Carbon Look

(*) Check price with your distributor.

IMPORTANT: Indicate code color after part#. Example: 0973A.

ADAPTORS TO ATTACH TO THE FAIRING

HI-TECH PARTS | TYPE OF REAR MIRROR:

2019
MODELS:
www.puig.tv



MODEL	YEAR	TYPE OF REAR MIRROR	SIDE	REF. ADAPTOR	REF. REAR MIRROR	N	C
YZF-R1	15' - 18'	RS2	RIGHT		7350	(*)	(*)
YZF-R1	15' - 18'	RS2	LEFT		7351	(*)	(*)
YZF-R3	15' -18'	HI-TECH I	RIGHT	9586N		(*)	
YZF-R3	15' -18'	HI-TECH I	LEFT	9586N		(*)	
YZF-R3	15' -18'	HI-TECH II	RIGHT	9586N		(*)	
YZF-R3	15' -18'	HI-TECH II	LEFT	9586N		(*)	
YZF-R3	15' -18'	HI-TECH III	RIGHT	9586N		(*)	
YZF-R3	15' -18'	HI-TECH III	LEFT	9586N		(*)	
YZF-R3	15' -18'	GT	RIGHT	9586N		(*)	
YZF-R3	15' -18'	GT	LEFT	9586N		(*)	
YZF-R3	15' -18'	F1	RIGHT	9586N		(*)	
YZF-R3	15' -18'	F1	LEFT	9586N		(*)	
YZF-R3	15' -18'	HYPERNAKED	RIGHT	9586N		(*)	
YZF-R3	15' -18'	HYPERNAKED	LEFT	9586N		(*)	
YZF-R3	15' -18'	EXPLORER	RIGHT	9586N		(*)	
YZF-R3	15' -18'	EXPLORER	LEFT	9586N		(*)	
YZF-R3	15' -18'	GTI	RIGHT	9586N		(*)	
YZF-R3	15' -18'	GTI	LEFT	9586N		(*)	
YZF-R3	15' -18'	RETRO	RIGHT	9586N		(*)	
YZF-R3	15' -18'	RETRO	LEFT	9586N		(*)	
YZF-R3	15' - 18'	RS1	RIGHT		7342	(*)	(*)
YZF-R3	15' - 18'	RS1	LEFT		7343	(*)	
YZF-R3	15' - 18'	RS2	RIGHT		7350	(*)	(*)
YZF-R3	15' - 18'	RS2	LEFT		7351	(*)	(*)
YZF-R6	99' - 05'	RS1	RIGHT		7342	(*)	(*)
YZF-R6	99' - 05'	RS1	LEFT		7343	(*)	
YZF-R6	99' - 05'	RS2	RIGHT		7350	(*)	(*)
YZF-R6	99' - 05'	RS2	LEFT		7351	(*)	(*)
YZF-R6	06' - 18'	RS1	RIGHT		7346	(*)	(*)
YZF-R6	06' - 18'	RS1	LEFT		7347	(*)	(*)
YZF-R6	06' - 18'	RS2	RIGHT		7354	(*)	(*)
YZF-R6	06' - 18'	RS2	LEFT		7355	(*)	(*)
YZF-R6	06' - 16'	HI-TECH I	RIGHT	9639N		(*)	
YZF-R6	06' - 16'	HI-TECH I	LEFT	9640N		(*)	
YZF-R6	06' - 16'	HI-TECH II	RIGHT	9639N		(*)	
YZF-R6	06' - 16'	HI-TECH II	LEFT	9640N		(*)	
YZF-R6	06' - 16'	HI-TECH III	RIGHT	9639N		(*)	
YZF-R6	06' - 16'	HI-TECH III	LEFT	9640N		(*)	
YZF-R6	06' - 16'	GT	RIGHT	9639N		(*)	
YZF-R6	06' - 16'	GT	LEFT	9640N		(*)	

MODEL	YEAR	TYPE OF REAR MIRROR	SIDE	REF. ADAPTOR	REF. REAR MIRROR	N	C
YZF-R6	06' - 16'	F1	RIGHT	9639N		(*)	
YZF-R6	06' - 16'	F1	LEFT	9640N		(*)	
YZF-R6	06' - 16'	HYPERNAKED	RIGHT	9639N		(*)	
YZF-R6	06' - 16'	HYPERNAKED	LEFT	9640N		(*)	
YZF-R6	06' - 16'	EXPLORER	RIGHT	9639N		(*)	
YZF-R6	06' - 16'	EXPLORER	LEFT	9640N		(*)	
YZF-R6	06' - 16'	GTI	RIGHT	9639N		(*)	
YZF-R6	06' - 16'	GTI	LEFT	9640N		(*)	
YZF-R6	06' - 16'	RETRO	RIGHT	9639N		(*)	
YZF-R6	06' - 16'	RETRO	LEFT	9640N		(*)	

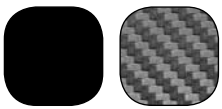

N
Black

C
Carbon Look

(*) Check price with your distributor.

IMPORTANT: Indicate code color after part#. Example: 0973A.

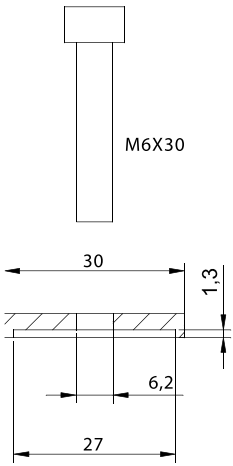

REF. 9427N

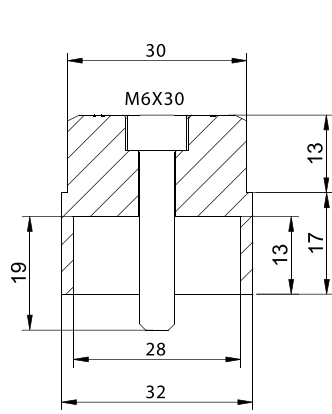

REF. 9500N

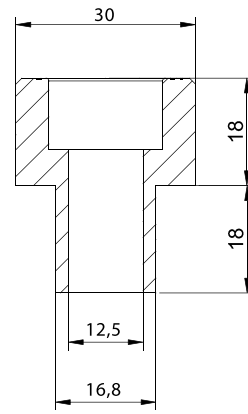

REF. 9580N

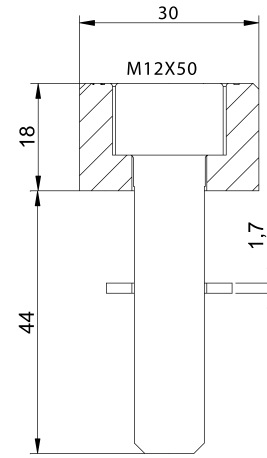

REF. 9581N

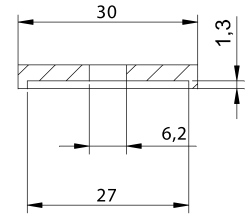

REF. 9582N

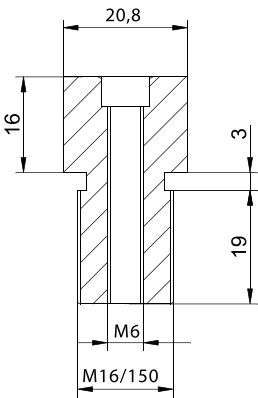

REF. 9583N

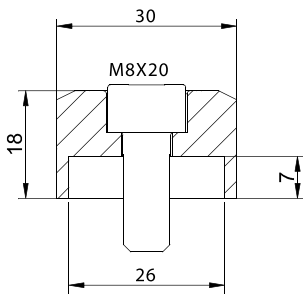

REF. 9584N

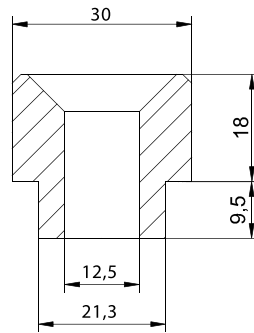

REF. 9587N

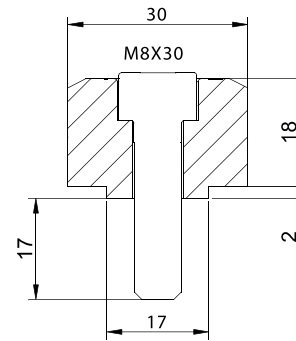

REF. 9850N

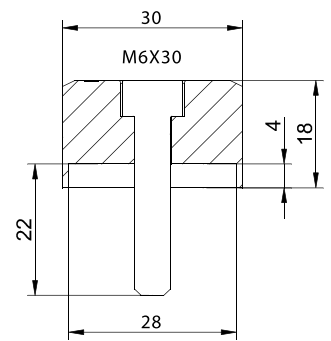

REF. 9871N

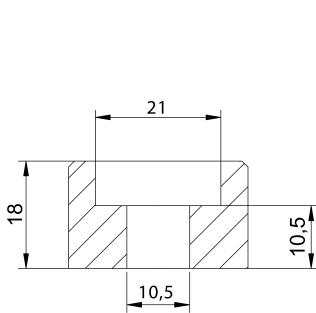

REF. 9990N

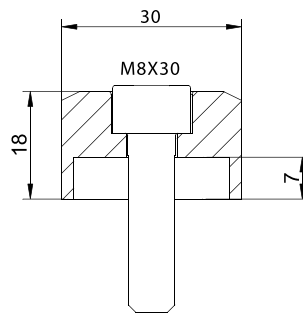

REF. 9991N

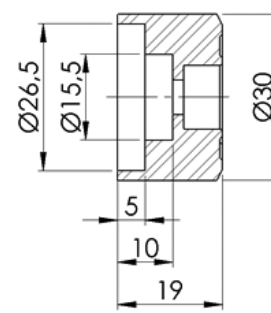

REF. 9699N

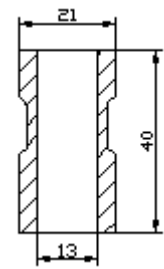

REF. 9662N

ADAPTORS TO BAR END REARVIEW MIRRORS

HI-TECH PARTS | TYPE OF REAR MIRROR:

2019
MODELS:
www.puig.tv

583



GRAND TRACKER

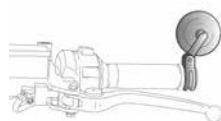

TRACKER



HI-TECH IV

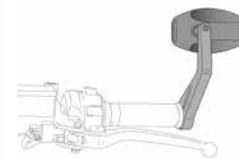

MP

MODEL	YEAR	TYPE OF REAR MIRROR	SIDE	REF. ADAPTOR	N	P
APRILIA						
SHIVER 900	17' - 18'	HI-TECH IV	RIGHT	9871N	(*)	
SHIVER 900	17' - 18'	HI-TECH IV	LEFT	9871N	(*)	
SHIVER 900	17' - 18'	MP	RIGHT	9871N	(*)	
SHIVER 900	17' - 18'	MP	LEFT	9871N	(*)	
SHIVER 900	17' - 18'	TRACKER	RIGHT	9871N	(*)	
SHIVER 900	17' - 18'	TRACKER	LEFT	9871N	(*)	
SHIVER 900	17' - 18'	GRAND TRACKER	RIGHT	9871N	(*)	
SHIVER 900	17' - 18'	GRAND TRACKER	LEFT	9871N	(*)	
BENELLI						
LEONCINO	16' - 18'	HI-TECH IV	RIGHT	9699N	(*)	
LEONCINO	16' - 18'	HI-TECH IV	LEFT	9699N	(*)	
LEONCINO	16' - 18'	MP	RIGHT	9699N	(*)	
LEONCINO	16' - 18'	MP	LEFT	9699N	(*)	
LEONCINO	16' - 18'	TRACKER	RIGHT	9699N	(*)	
LEONCINO	16' - 18'	TRACKER	LEFT	9699N	(*)	
LEONCINO	16' - 18'	GRAND TRACKER	RIGHT	9699N	(*)	
LEONCINO	16' - 18'	GRAND TRACKER	LEFT	9699N	(*)	
BMW						
G310 R	16' - 18'	HI-TECH IV	RIGHT	9850N	(*)	
G310 R	16' - 18'	HI-TECH IV	LEFT	9850N	(*)	
G310 R	16' - 18'	MP	RIGHT	9850N	(*)	
G310 R	16' - 18'	MP	LEFT	9850N	(*)	
G310 R	16' - 18'	TRACKER	RIGHT	9850N	(*)	
G310 R	16' - 18'	TRACKER	LEFT	9850N	(*)	
G310 R	16' - 18'	GRAND TRACKER	RIGHT	9850N	(*)	
G310 R	16' - 18'	GRAND TRACKER	LEFT	9850N	(*)	
C600 SPORT	12' - 15'	HI-TECH IV	RIGHT	9580N	(*)	
C600 SPORT	12' - 15'	HI-TECH IV	LEFT	9580N	(*)	
C600 SPORT	12' - 15'	MP	RIGHT	9580N	(*)	
C600 SPORT	12' - 15'	MP	LEFT	9580N	(*)	
C600 SPORT	12' - 15'	TRACKER	RIGHT	9580N	(*)	
C600 SPORT	12' - 15'	TRACKER	LEFT	9580N	(*)	
C600 SPORT	12' - 15'	GRAND TRACKER	RIGHT	9580N	(*)	



N

Black

P

Silver

(*) Check price with your distributor.

IMPORTANT: Indicate code color after part#. Example: 0973A.

ADAPTORS TO BAR END REARVIEW MIRRORS

HI-TECH PARTS | TYPE OF REAR MIRROR:

2019
MODELS:
www.puig.tv



GRAND TRACKER



TRACKER

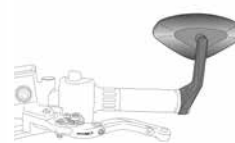

HI-TECH IV

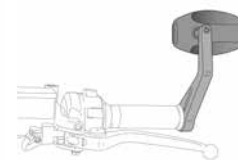

MP

MODEL	YEAR	TYPE OF REAR MIRROR	SIDE	REF. ADAPTOR	N	P
C600 SPORT	12' - 15'	GRAND TRACKER	LEFT	9580N	(*)	
C650 SPORT	16' - 18'	HI-TECH IV	RIGHT	9580N	(*)	
C650 SPORT	16' - 18'	HI-TECH IV	LEFT	9580N	(*)	
C650 SPORT	16' - 18'	MP	RIGHT	9580N	(*)	
C650 SPORT	16' - 18'	MP	LEFT	9580N	(*)	
C650 SPORT	16' - 18'	TRACKER	RIGHT	9580N	(*)	
C650 SPORT	16' - 18'	TRACKER	LEFT	9580N	(*)	
C650 SPORT	16' - 18'	GRAND TRACKER	RIGHT	9580N	(*)	
C650 SPORT	16' - 18'	GRAND TRACKER	LEFT	9580N	(*)	
F800 R	09' - 18'	HI-TECH IV	RIGHT	9587N	(*)	
F800 R	09' - 18'	HI-TECH IV	LEFT	9587N	(*)	
F800 R	09' - 18'	MP	RIGHT	9587N	(*)	
F800 R	09' - 18'	MP	LEFT	9587N	(*)	
F800 R	09' - 18'	TRACKER	RIGHT	9587N	(*)	
F800 R	09' - 18'	TRACKER	LEFT	9587N	(*)	
F800 R	09' - 18'	GRAND TRACKER	RIGHT	9587N	(*)	
F800 R	09' - 18'	GRAND TRACKER	LEFT	9587N	(*)	
R1200 R	09' - 18'	HI-TECH IV	RIGHT	9990N	(*)	
R1200 R	09' - 18'	HI-TECH IV	LEFT	9990N	(*)	
R1200 R	09' - 18'	MP	RIGHT	9990N	(*)	
R1200 R	09' - 18'	MP	LEFT	9990N	(*)	
R1200 R	09' - 18'	TRACKER	RIGHT	9990N	(*)	
R1200 R	09' - 18'	TRACKER	LEFT	9990N	(*)	
R1200 R	09' - 18'	GRAND TRACKER	RIGHT	9990N	(*)	
R1200 R	09' - 18'	GRAND TRACKER	LEFT	9990N	(*)	
R NINE T/SCRAMBLER/PURE/URBAN G/S		HI-TECH IV	RIGHT	9581N	(*)	
R NINE T/SCRAMBLER/PURE/URBAN G/S		HI-TECH IV	LEFT	9581N	(*)	
R NINE T/SCRAMBLER/PURE/URBAN G/S		MP	RIGHT	9581N	(*)	
R NINE T/SCRAMBLER/PURE/URBAN G/S		MP	LEFT	9581N	(*)	
R NINE T/SCRAMBLER/PURE/URBAN G/S		TRACKER	RIGHT	9581N	(*)	
R NINE T/SCRAMBLER/PURE/URBAN G/S		TRACKER	LEFT	9581N	(*)	
R NINE T/SCRAMBLER/PURE/URBAN G/S		GRAND TRACKER	RIGHT	9581N	(*)	
R NINE T/SCRAMBLER/PURE/URBAN G/S		GRAND TRACKER	LEFT	9581N	(*)	
S1000 R	14' - 18'	HI-TECH IV	RIGHT	9581N	(*)	
S1000 R	14' - 18'	HI-TECH IV	LEFT	9581N	(*)	
S1000 R	14' - 18'	MP	RIGHT	9581N	(*)	
S1000 R	14' - 18'	MP	LEFT	9581N	(*)	
S1000 R	14' - 18'	TRACKER	RIGHT	9581N	(*)	
S1000 R	14' - 18'	TRACKER	LEFT	9581N	(*)	
S1000 R	14' - 18'	GRAND TRACKER	RIGHT	9581N	(*)	

MODEL	YEAR	TYPE OF REAR MIRROR	SIDE	REF. ADAPTOR	N	P
S1000 R	14' - 18'	GRAND TRACKER	LEFT	9581N	(*)	
DUCATI						
X DIAVEL	16' - 18'	HI-TECH IV	RIGHT	UNIVERSAL - IT DOES NOT REQUIRE ADAPTOR		
X DIAVEL	16' - 18'	HI-TECH IV	LEFT	UNIVERSAL - IT DOES NOT REQUIRE ADAPTOR		
X DIAVEL	16' - 18'	MP	RIGHT	UNIVERSAL - IT DOES NOT REQUIRE ADAPTOR		
X DIAVEL	16' - 18'	MP	LEFT	UNIVERSAL - IT DOES NOT REQUIRE ADAPTOR		
X DIAVEL	16' - 18'	TRACKER	RIGHT	UNIVERSAL - IT DOES NOT REQUIRE ADAPTOR		
X DIAVEL	16' - 18'	TRACKER	LEFT	UNIVERSAL - IT DOES NOT REQUIRE ADAPTOR		
X DIAVEL	16' - 18'	GRAND TRACKER	RIGHT	UNIVERSAL - IT DOES NOT REQUIRE ADAPTOR		
X DIAVEL	16' - 18'	GRAND TRACKER	LEFT	UNIVERSAL - IT DOES NOT REQUIRE ADAPTOR		
STREETFIGHTER 848	12' - 16'	HI-TECH IV	RIGHT	UNIVERSAL - IT DOES NOT REQUIRE ADAPTOR		
STREETFIGHTER 848	12' - 16'	HI-TECH IV	LEFT	UNIVERSAL - IT DOES NOT REQUIRE ADAPTOR		
STREETFIGHTER 848	12' - 16'	MP	RIGHT	UNIVERSAL - IT DOES NOT REQUIRE ADAPTOR		
STREETFIGHTER 848	12' - 16'	MP	LEFT	UNIVERSAL - IT DOES NOT REQUIRE ADAPTOR		
STREETFIGHTER 848	12' - 16'	TRACKER	RIGHT	UNIVERSAL - IT DOES NOT REQUIRE ADAPTOR		
STREETFIGHTER 848	12' - 16'	TRACKER	LEFT	UNIVERSAL - IT DOES NOT REQUIRE ADAPTOR		
STREETFIGHTER 848	12' - 16'	GRAND TRACKER	RIGHT	UNIVERSAL - IT DOES NOT REQUIRE ADAPTOR		
STREETFIGHTER 848	12' - 16'	GRAND TRACKER	LEFT	UNIVERSAL - IT DOES NOT REQUIRE ADAPTOR		
STREETFIGHTER 1100/S		HI-TECH IV	RIGHT	UNIVERSAL - IT DOES NOT REQUIRE ADAPTOR		
STREETFIGHTER 1100/S		HI-TECH IV	LEFT	UNIVERSAL - IT DOES NOT REQUIRE ADAPTOR		
STREETFIGHTER 1100/S		MP	RIGHT	UNIVERSAL - IT DOES NOT REQUIRE ADAPTOR		
STREETFIGHTER 1100/S		MP	LEFT	UNIVERSAL - IT DOES NOT REQUIRE ADAPTOR		
STREETFIGHTER 1100/S		TRACKER	RIGHT	UNIVERSAL - IT DOES NOT REQUIRE ADAPTOR		
STREETFIGHTER 1100/S		TRACKER	LEFT	UNIVERSAL - IT DOES NOT REQUIRE ADAPTOR		
STREETFIGHTER 1100/S		GRAND TRACKER	RIGHT	UNIVERSAL - IT DOES NOT REQUIRE ADAPTOR		
STREETFIGHTER 1100/S		GRAND TRACKER	LEFT	UNIVERSAL - IT DOES NOT REQUIRE ADAPTOR		
MONSTER 696	08' - 14'	HI-TECH IV	RIGHT	UNIVERSAL - IT DOES NOT REQUIRE ADAPTOR		
MONSTER 696	08' - 14'	HI-TECH IV	LEFT	UNIVERSAL - IT DOES NOT REQUIRE ADAPTOR		
MONSTER 696	08' - 14'	MP	RIGHT	UNIVERSAL - IT DOES NOT REQUIRE ADAPTOR		
MONSTER 696	08' - 14'	MP	LEFT	UNIVERSAL - IT DOES NOT REQUIRE ADAPTOR		
MONSTER 696	08' - 14'	TRACKER	RIGHT	UNIVERSAL - IT DOES NOT REQUIRE ADAPTOR		
MONSTER 696	08' - 14'	TRACKER	LEFT	UNIVERSAL - IT DOES NOT REQUIRE ADAPTOR		
MONSTER 696	08' - 14'	GRAND TRACKER	RIGHT	UNIVERSAL - IT DOES NOT REQUIRE ADAPTOR		
MONSTER 696	08' - 14'	GRAND TRACKER	LEFT	UNIVERSAL - IT DOES NOT REQUIRE ADAPTOR		
MONSTER 796	10' - 14'	HI-TECH IV	RIGHT	UNIVERSAL - IT DOES NOT REQUIRE ADAPTOR		
MONSTER 796	10' - 14'	HI-TECH IV	LEFT	UNIVERSAL - IT DOES NOT REQUIRE ADAPTOR		
MONSTER 796	10' - 14'	MP	RIGHT	UNIVERSAL - IT DOES NOT REQUIRE ADAPTOR		
MONSTER 796	10' - 14'	MP	LEFT	UNIVERSAL - IT DOES NOT REQUIRE ADAPTOR		
MONSTER 796	10' - 14'	TRACKER	RIGHT	UNIVERSAL - IT DOES NOT REQUIRE ADAPTOR		
MONSTER 796	10' - 14'	TRACKER	LEFT	UNIVERSAL - IT DOES NOT REQUIRE ADAPTOR		
MONSTER 796	10' - 14'	GRAND TRACKER	RIGHT	UNIVERSAL - IT DOES NOT REQUIRE ADAPTOR		
MONSTER 796	10' - 14'	GRAND TRACKER	LEFT	UNIVERSAL - IT DOES NOT REQUIRE ADAPTOR		
MONSTER 1100	09' - 10'	HI-TECH IV	RIGHT	UNIVERSAL - IT DOES NOT REQUIRE ADAPTOR		
MONSTER 1100	09' - 10'	HI-TECH IV	LEFT	UNIVERSAL - IT DOES NOT REQUIRE ADAPTOR		



N
Black

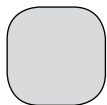

P
Silver

(*) Check price with your distributor.

IMPORTANT: Indicate code color after part#. Example: 0973A.

ADAPTORS TO BAR END REARVIEW MIRRORS

HI-TECH PARTS | TYPE OF REAR MIRROR:

2019
MODELS:
www.puig.tv



GRAND TRACKER



TRACKER



HI-TECH IV

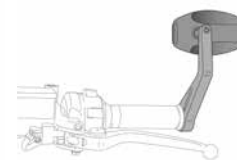

MP

MODEL	YEAR	TYPE OF REAR MIRROR	SIDE	REF. ADAPTOR	N	P
MONSTER 1100	09' - 10'	MP	RIGHT	UNIVERSAL - IT DOES NOT REQUIRE ADAPTOR		
MONSTER 1100	09' - 10'	MP	LEFT	UNIVERSAL - IT DOES NOT REQUIRE ADAPTOR		
MONSTER 1100	09' - 10'	TRACKER	RIGHT	UNIVERSAL - IT DOES NOT REQUIRE ADAPTOR		
MONSTER 1100	09' - 10'	TRACKER	LEFT	UNIVERSAL - IT DOES NOT REQUIRE ADAPTOR		
MONSTER 1100	09' - 10'	GRAND TRACKER	RIGHT	UNIVERSAL - IT DOES NOT REQUIRE ADAPTOR		
MONSTER 1100	09' - 10'	GRAND TRACKER	LEFT	UNIVERSAL - IT DOES NOT REQUIRE ADAPTOR		
MONSTER 1100 EVO	11' - 13'	HI-TECH IV	RIGHT	UNIVERSAL - IT DOES NOT REQUIRE ADAPTOR		
MONSTER 1100 EVO	11' - 13'	HI-TECH IV	LEFT	UNIVERSAL - IT DOES NOT REQUIRE ADAPTOR		
MONSTER 1100 EVO	11' - 13'	MP	RIGHT	UNIVERSAL - IT DOES NOT REQUIRE ADAPTOR		
MONSTER 1100 EVO	11' - 13'	MP	LEFT	UNIVERSAL - IT DOES NOT REQUIRE ADAPTOR		
MONSTER 1100 EVO	11' - 13'	TRACKER	RIGHT	UNIVERSAL - IT DOES NOT REQUIRE ADAPTOR		
MONSTER 1100 EVO	11' - 13'	TRACKER	LEFT	UNIVERSAL - IT DOES NOT REQUIRE ADAPTOR		
MONSTER 1100 EVO	11' - 13'	GRAND TRACKER	RIGHT	UNIVERSAL - IT DOES NOT REQUIRE ADAPTOR		
MONSTER 1100 EVO	11' - 13'	GRAND TRACKER	LEFT	UNIVERSAL - IT DOES NOT REQUIRE ADAPTOR		
MONSTER 797	17' -18'	HI-TECH IV	RIGHT	UNIVERSAL - IT DOES NOT REQUIRE ADAPTOR		
MONSTER 797	17' -18'	HI-TECH IV	LEFT	UNIVERSAL - IT DOES NOT REQUIRE ADAPTOR		
MONSTER 797	17' -18'	MP	RIGHT	UNIVERSAL - IT DOES NOT REQUIRE ADAPTOR		
MONSTER 797	17' -18'	MP	LEFT	UNIVERSAL - IT DOES NOT REQUIRE ADAPTOR		
MONSTER 797	17' -18'	TRACKER	RIGHT	UNIVERSAL - IT DOES NOT REQUIRE ADAPTOR		
MONSTER 797	17' -18'	TRACKER	LEFT	UNIVERSAL - IT DOES NOT REQUIRE ADAPTOR		
MONSTER 797	17' -18'	GRAND TRACKER	RIGHT	UNIVERSAL - IT DOES NOT REQUIRE ADAPTOR		
MONSTER 797	17' -18'	GRAND TRACKER	LEFT	UNIVERSAL - IT DOES NOT REQUIRE ADAPTOR		
MONSTER 821/1200/S	14' - 17'	HI-TECH IV	RIGHT	UNIVERSAL - IT DOES NOT REQUIRE ADAPTOR		
MONSTER 821/1200/S	14' - 17'	HI-TECH IV	LEFT	UNIVERSAL - IT DOES NOT REQUIRE ADAPTOR		
MONSTER 821/1200/S	14' - 17'	MP	RIGHT	UNIVERSAL - IT DOES NOT REQUIRE ADAPTOR		
MONSTER 821/1200/S	14' - 17'	MP	LEFT	UNIVERSAL - IT DOES NOT REQUIRE ADAPTOR		
MONSTER 821/1200/S	14' - 17'	TRACKER	RIGHT	UNIVERSAL - IT DOES NOT REQUIRE ADAPTOR		
MONSTER 821/1200/S	14' - 17'	TRACKER	LEFT	UNIVERSAL - IT DOES NOT REQUIRE ADAPTOR		
MONSTER 821/1200/S	14' - 17'	GRAND TRACKER	RIGHT	UNIVERSAL - IT DOES NOT REQUIRE ADAPTOR		
MONSTER 821/1200/S	14' - 17'	GRAND TRACKER	LEFT	UNIVERSAL - IT DOES NOT REQUIRE ADAPTOR		
MONSTER 821	18'	HI-TECH IV	RIGHT	UNIVERSAL - IT DOES NOT REQUIRE ADAPTOR		
MONSTER 821	18'	HI-TECH IV	LEFT	UNIVERSAL - IT DOES NOT REQUIRE ADAPTOR		
MONSTER 821	18'	MP	RIGHT	UNIVERSAL - IT DOES NOT REQUIRE ADAPTOR		
MONSTER 821	18'	MP	LEFT	UNIVERSAL - IT DOES NOT REQUIRE ADAPTOR		
MONSTER 821	18'	TRACKER	RIGHT	UNIVERSAL - IT DOES NOT REQUIRE ADAPTOR		
MONSTER 821	18'	TRACKER	LEFT	UNIVERSAL - IT DOES NOT REQUIRE ADAPTOR		
MONSTER 821	18'	GRAND TRACKER	RIGHT	UNIVERSAL - IT DOES NOT REQUIRE ADAPTOR		
MONSTER 821	18'	GRAND TRACKER	LEFT	UNIVERSAL - IT DOES NOT REQUIRE ADAPTOR		
MONSTER 1200 R	16' - 18'	HI-TECH IV	RIGHT	UNIVERSAL - IT DOES NOT REQUIRE ADAPTOR		
MONSTER 1200 R	16' - 18'	HI-TECH IV	LEFT	UNIVERSAL - IT DOES NOT REQUIRE ADAPTOR		

MODEL	YEAR	TYPE OF REAR MIRROR	SIDE	REF. ADAPTOR	N	P
MONSTER 1200 R	16' - 18'	MP	RIGHT	UNIVERSAL - IT DOES NOT REQUIRE ADAPTOR		
MONSTER 1200 R	16' - 18'	MP	LEFT	UNIVERSAL - IT DOES NOT REQUIRE ADAPTOR		
MONSTER 1200 R	16' - 18'	TRACKER	RIGHT	UNIVERSAL - IT DOES NOT REQUIRE ADAPTOR		
MONSTER 1200 R	16' - 18'	TRACKER	LEFT	UNIVERSAL - IT DOES NOT REQUIRE ADAPTOR		
MONSTER 1200 R	16' - 18'	GRAND TRACKER	RIGHT	UNIVERSAL - IT DOES NOT REQUIRE ADAPTOR		
MONSTER 1200 R	16' - 18'	GRAND TRACKER	LEFT	UNIVERSAL - IT DOES NOT REQUIRE ADAPTOR		
SCRAMBLER ICON	15' - 18'	HI-TECH IV	RIGHT	UNIVERSAL - IT DOES NOT REQUIRE ADAPTOR		
SCRAMBLER ICON	15' - 18'	HI-TECH IV	LEFT	UNIVERSAL - IT DOES NOT REQUIRE ADAPTOR		
SCRAMBLER ICON	15' - 18'	MP	RIGHT	UNIVERSAL - IT DOES NOT REQUIRE ADAPTOR		
SCRAMBLER ICON	15' - 18'	MP	LEFT	UNIVERSAL - IT DOES NOT REQUIRE ADAPTOR		
SCRAMBLER ICON	15' - 18'	TRACKER	RIGHT	UNIVERSAL - IT DOES NOT REQUIRE ADAPTOR		
SCRAMBLER ICON	15' - 18'	TRACKER	LEFT	UNIVERSAL - IT DOES NOT REQUIRE ADAPTOR		
SCRAMBLER ICON	15' - 18'	GRAND TRACKER	RIGHT	UNIVERSAL - IT DOES NOT REQUIRE ADAPTOR		
SCRAMBLER ICON	15' - 18'	GRAND TRACKER	LEFT	UNIVERSAL - IT DOES NOT REQUIRE ADAPTOR		
SCRAMBLER CLASSIC	15' - 18'	HI-TECH IV	RIGHT	UNIVERSAL - IT DOES NOT REQUIRE ADAPTOR		
SCRAMBLER CLASSIC	15' - 18'	HI-TECH IV	LEFT	UNIVERSAL - IT DOES NOT REQUIRE ADAPTOR		
SCRAMBLER CLASSIC	15' - 18'	MP	RIGHT	UNIVERSAL - IT DOES NOT REQUIRE ADAPTOR		
SCRAMBLER CLASSIC	15' - 18'	MP	LEFT	UNIVERSAL - IT DOES NOT REQUIRE ADAPTOR		
SCRAMBLER CLASSIC	15' - 18'	TRACKER	RIGHT	UNIVERSAL - IT DOES NOT REQUIRE ADAPTOR		
SCRAMBLER CLASSIC	15' - 18'	TRACKER	LEFT	UNIVERSAL - IT DOES NOT REQUIRE ADAPTOR		
SCRAMBLER CLASSIC	15' - 18'	GRAND TRACKER	RIGHT	UNIVERSAL - IT DOES NOT REQUIRE ADAPTOR		
SCRAMBLER CLASSIC	15' - 18'	GRAND TRACKER	LEFT	UNIVERSAL - IT DOES NOT REQUIRE ADAPTOR		
SCRAMBLER URBAN ENDURO	15' - 16'	HI-TECH IV	RIGHT	UNIVERSAL - IT DOES NOT REQUIRE ADAPTOR		
SCRAMBLER URBAN ENDURO	15' - 16'	HI-TECH IV	LEFT	UNIVERSAL - IT DOES NOT REQUIRE ADAPTOR		
SCRAMBLER URBAN ENDURO	15' - 16'	MP	RIGHT	UNIVERSAL - IT DOES NOT REQUIRE ADAPTOR		
SCRAMBLER URBAN ENDURO	15' - 16'	MP	LEFT	UNIVERSAL - IT DOES NOT REQUIRE ADAPTOR		
SCRAMBLER URBAN ENDURO	15' - 16'	TRACKER	RIGHT	UNIVERSAL - IT DOES NOT REQUIRE ADAPTOR		
SCRAMBLER URBAN ENDURO	15' - 16'	TRACKER	LEFT	UNIVERSAL - IT DOES NOT REQUIRE ADAPTOR		
SCRAMBLER URBAN ENDURO	15' - 16'	GRAND TRACKER	RIGHT	UNIVERSAL - IT DOES NOT REQUIRE ADAPTOR		
SCRAMBLER URBAN ENDURO	15' - 16'	GRAND TRACKER	LEFT	UNIVERSAL - IT DOES NOT REQUIRE ADAPTOR		
SCRAMBLER FULL THROTTLE	15' - 18'	HI-TECH IV	RIGHT	UNIVERSAL - IT DOES NOT REQUIRE ADAPTOR		
SCRAMBLER FULL THROTTLE	15' - 18'	HI-TECH IV	LEFT	UNIVERSAL - IT DOES NOT REQUIRE ADAPTOR		
SCRAMBLER FULL THROTTLE	15' - 18'	MP	RIGHT	UNIVERSAL - IT DOES NOT REQUIRE ADAPTOR		
SCRAMBLER FULL THROTTLE	15' - 18'	MP	LEFT	UNIVERSAL - IT DOES NOT REQUIRE ADAPTOR		
SCRAMBLER FULL THROTTLE	15' - 18'	TRACKER	RIGHT	UNIVERSAL - IT DOES NOT REQUIRE ADAPTOR		
SCRAMBLER FULL THROTTLE	15' - 18'	TRACKER	LEFT	UNIVERSAL - IT DOES NOT REQUIRE ADAPTOR		
SCRAMBLER FULL THROTTLE	15' - 18'	GRAND TRACKER	RIGHT	UNIVERSAL - IT DOES NOT REQUIRE ADAPTOR		
SCRAMBLER FULL THROTTLE	15' - 18'	GRAND TRACKER	LEFT	UNIVERSAL - IT DOES NOT REQUIRE ADAPTOR		
SCRAMBLER SIXTY2	16' - 18'	HI-TECH IV	RIGHT	UNIVERSAL - IT DOES NOT REQUIRE ADAPTOR		
SCRAMBLER SIXTY2	16' - 18'	HI-TECH IV	LEFT	UNIVERSAL - IT DOES NOT REQUIRE ADAPTOR		
SCRAMBLER SIXTY2	16' - 18'	MP	RIGHT	UNIVERSAL - IT DOES NOT REQUIRE ADAPTOR		
SCRAMBLER SIXTY2	16' - 18'	MP	LEFT	UNIVERSAL - IT DOES NOT REQUIRE ADAPTOR		
SCRAMBLER SIXTY2	16' - 18'	TRACKER	RIGHT	UNIVERSAL - IT DOES NOT REQUIRE ADAPTOR		
SCRAMBLER SIXTY2	16' - 18'	TRACKER	LEFT	UNIVERSAL - IT DOES NOT REQUIRE ADAPTOR		



N
Black

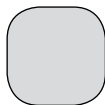

P
Silver

(*) Check price with your distributor.

IMPORTANT: Indicate code color after part#. Example: 0973A.

ADAPTORS TO BAR END REARVIEW MIRRORS

HI-TECH PARTS | TYPE OF REAR MIRROR:

2019
MODELS:
www.puig.tv



GRAND TRACKER

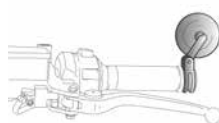

TRACKER



HI-TECH IV

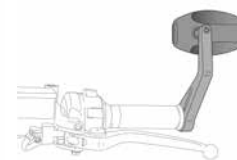

MP

MODEL	YEAR	TYPE OF REAR MIRROR	SIDE	REF. ADAPTOR	N	P
SCRAMBLER SIXTY2	16' - 18'	GRAND TRACKER	RIGHT	UNIVERSAL - IT DOES NOT REQUIRE ADAPTOR		
SCRAMBLER SIXTY2	16' - 18'	GRAND TRACKER	LEFT	UNIVERSAL - IT DOES NOT REQUIRE ADAPTOR		
SCRAMBLER FLAT TRACK PRO	16'	HI-TECH IV	RIGHT	UNIVERSAL - IT DOES NOT REQUIRE ADAPTOR		
SCRAMBLER FLAT TRACK PRO	16'	HI-TECH IV	LEFT	UNIVERSAL - IT DOES NOT REQUIRE ADAPTOR		
SCRAMBLER FLAT TRACK PRO	16'	MP	RIGHT	UNIVERSAL - IT DOES NOT REQUIRE ADAPTOR		
SCRAMBLER FLAT TRACK PRO	16'	MP	LEFT	UNIVERSAL - IT DOES NOT REQUIRE ADAPTOR		
SCRAMBLER FLAT TRACK PRO	16'	TRACKER	RIGHT	UNIVERSAL - IT DOES NOT REQUIRE ADAPTOR		
SCRAMBLER FLAT TRACK PRO	16'	TRACKER	LEFT	UNIVERSAL - IT DOES NOT REQUIRE ADAPTOR		
SCRAMBLER FLAT TRACK PRO	16'	GRAND TRACKER	RIGHT	UNIVERSAL - IT DOES NOT REQUIRE ADAPTOR		
SCRAMBLER FLAT TRACK PRO	16'	GRAND TRACKER	LEFT	UNIVERSAL - IT DOES NOT REQUIRE ADAPTOR		
SCRAMBLER DESERT SLED	17' - 18'	HI-TECH IV	RIGHT	UNIVERSAL - IT DOES NOT REQUIRE ADAPTOR		
SCRAMBLER DESERT SLED	17' - 18'	HI-TECH IV	LEFT	UNIVERSAL - IT DOES NOT REQUIRE ADAPTOR		
SCRAMBLER DESERT SLED	17' - 18'	MP	RIGHT	UNIVERSAL - IT DOES NOT REQUIRE ADAPTOR		
SCRAMBLER DESERT SLED	17' - 18'	MP	LEFT	UNIVERSAL - IT DOES NOT REQUIRE ADAPTOR		
SCRAMBLER DESERT SLED	17' - 18'	TRACKER	RIGHT	UNIVERSAL - IT DOES NOT REQUIRE ADAPTOR		
SCRAMBLER DESERT SLED	17' - 18'	TRACKER	LEFT	UNIVERSAL - IT DOES NOT REQUIRE ADAPTOR		
SCRAMBLER DESERT SLED	17' - 18'	GRAND TRACKER	RIGHT	UNIVERSAL - IT DOES NOT REQUIRE ADAPTOR		
SCRAMBLER DESERT SLED	17' - 18'	GRAND TRACKER	LEFT	UNIVERSAL - IT DOES NOT REQUIRE ADAPTOR		
SCRAMBLER CAFE RACER	17' - 18'	HI-TECH IV	RIGHT	9991N	(*)	
SCRAMBLER CAFE RACER	17' - 18'	HI-TECH IV	LEFT	9991N	(*)	
SCRAMBLER CAFE RACER	17' - 18'	MP	RIGHT	9991N	(*)	
SCRAMBLER CAFE RACER	17' - 18'	MP	LEFT	9991N	(*)	
SCRAMBLER CAFE RACER	17' - 18'	TRACKER	RIGHT	9991N	(*)	
SCRAMBLER CAFE RACER	17' - 18'	TRACKER	LEFT	9991N	(*)	
SCRAMBLER CAFE RACER	17' - 18'	GRAND TRACKER	RIGHT	9991N	(*)	
SCRAMBLER CAFE RACER	17' - 18'	GRAND TRACKER	LEFT	9991N	(*)	
SCRAMBLER 1100	18'	HI-TECH IV	RIGHT	UNIVERSAL - IT DOES NOT REQUIRE ADAPTOR		
SCRAMBLER 1100	18'	HI-TECH IV	LEFT	UNIVERSAL - IT DOES NOT REQUIRE ADAPTOR		
SCRAMBLER 1100	18'	MP	RIGHT	UNIVERSAL - IT DOES NOT REQUIRE ADAPTOR		
SCRAMBLER 1100	18'	MP	LEFT	UNIVERSAL - IT DOES NOT REQUIRE ADAPTOR		
SCRAMBLER 1100	18'	TRACKER	RIGHT	UNIVERSAL - IT DOES NOT REQUIRE ADAPTOR		
SCRAMBLER 1100	18'	TRACKER	LEFT	UNIVERSAL - IT DOES NOT REQUIRE ADAPTOR		
SCRAMBLER 1100	18'	GRAND TRACKER	RIGHT	UNIVERSAL - IT DOES NOT REQUIRE ADAPTOR		
SCRAMBLER 1100	18'	GRAND TRACKER	LEFT	UNIVERSAL - IT DOES NOT REQUIRE ADAPTOR		
SCRAMBLER 1100 SPORT	18'	HI-TECH IV	RIGHT	UNIVERSAL - IT DOES NOT REQUIRE ADAPTOR		
SCRAMBLER 1100 SPORT	18'	HI-TECH IV	LEFT	UNIVERSAL - IT DOES NOT REQUIRE ADAPTOR		
SCRAMBLER 1100 SPORT	18'	MP	RIGHT	UNIVERSAL - IT DOES NOT REQUIRE ADAPTOR		
SCRAMBLER 1100 SPORT	18'	MP	LEFT	UNIVERSAL - IT DOES NOT REQUIRE ADAPTOR		
SCRAMBLER 1100 SPORT	18'	TRACKER	RIGHT	UNIVERSAL - IT DOES NOT REQUIRE ADAPTOR		
SCRAMBLER 1100 SPORT	18'	TRACKER	LEFT	UNIVERSAL - IT DOES NOT REQUIRE ADAPTOR		

MODEL	YEAR	TYPE OF REAR MIRROR	SIDE	REF. ADAPTOR	N	P
SCRAMBLER 1100 SPORT	18'	GRAND TRACKER	RIGHT	UNIVERSAL - IT DOES NOT REQUIRE ADAPTOR		
SCRAMBLER 1100 SPORT	18'	GRAND TRACKER	LEFT	UNIVERSAL - IT DOES NOT REQUIRE ADAPTOR		
SCRAMBLER 1100 SPECIAL	18'	HI-TECH IV	RIGHT	UNIVERSAL - IT DOES NOT REQUIRE ADAPTOR		
SCRAMBLER 1100 SPECIAL	18'	HI-TECH IV	LEFT	UNIVERSAL - IT DOES NOT REQUIRE ADAPTOR		
SCRAMBLER 1100 SPECIAL	18'	MP	RIGHT	UNIVERSAL - IT DOES NOT REQUIRE ADAPTOR		
SCRAMBLER 1100 SPECIAL	18'	MP	LEFT	UNIVERSAL - IT DOES NOT REQUIRE ADAPTOR		
SCRAMBLER 1100 SPECIAL	18'	TRACKER	RIGHT	UNIVERSAL - IT DOES NOT REQUIRE ADAPTOR		
SCRAMBLER 1100 SPECIAL	18'	TRACKER	LEFT	UNIVERSAL - IT DOES NOT REQUIRE ADAPTOR		
SCRAMBLER 1100 SPECIAL	18'	GRAND TRACKER	RIGHT	UNIVERSAL - IT DOES NOT REQUIRE ADAPTOR		
SCRAMBLER 1100 SPECIAL	18'	GRAND TRACKER	LEFT	UNIVERSAL - IT DOES NOT REQUIRE ADAPTOR		
HARLEY DAVIDSON						
SPORTSTER 883 IRON (XL883N)	09'-13'	HI-TECH IV	RIGHT	9662N	(*)	
SPORTSTER 883 IRON (XL883N)	09'-13'	HI-TECH IV	LEFT	9662N	(*)	
SPORTSTER 883 IRON (XL883N)	09'-13'	MP	RIGHT	9662N	(*)	
SPORTSTER 883 IRON (XL883N)	09'-13'	MP	LEFT	9662N	(*)	
SPORTSTER 883 IRON (XL883N)	09'-13'	TRACKER	RIGHT	9662N	(*)	
SPORTSTER 883 IRON (XL883N)	09'-13'	TRACKER	LEFT	9662N	(*)	
SPORTSTER 883 IRON (XL883N)	09'-13'	GRAND TRACKER	RIGHT	9662N	(*)	
SPORTSTER 883 IRON (XL883N)	09'-13'	GRAND TRACKER	LEFT	9662N	(*)	
SPORTSTER 883 IRON (XL883N)	14'-16'	HI-TECH IV	RIGHT	9662N	(*)	
SPORTSTER 883 IRON (XL883N)	14'-16'	HI-TECH IV	LEFT	9662N	(*)	
SPORTSTER 883 IRON (XL883N)	14'-16'	MP	RIGHT	9662N	(*)	
SPORTSTER 883 IRON (XL883N)	14'-16'	MP	LEFT	9662N	(*)	
SPORTSTER 883 IRON (XL883N)	14'-16'	TRACKER	RIGHT	9662N	(*)	
SPORTSTER 883 IRON (XL883N)	14'-16'	TRACKER	LEFT	9662N	(*)	
SPORTSTER 883 IRON (XL883N)	14'-16'	GRAND TRACKER	RIGHT	9662N	(*)	
SPORTSTER 883 IRON (XL883N)	14'-16'	GRAND TRACKER	LEFT	9662N	(*)	
SPORTSTER 883 IRON (XL883N/17)	17' - 18'	HI-TECH IV	RIGHT	9662N	(*)	
SPORTSTER 883 IRON (XL883N/17)	17' - 18'	HI-TECH IV	LEFT	9662N	(*)	
SPORTSTER 883 IRON (XL883N/17)	17' - 18'	MP	RIGHT	9662N	(*)	
SPORTSTER 883 IRON (XL883N/17)	17' - 18'	MP	LEFT	9662N	(*)	
SPORTSTER 883 IRON (XL883N/17)	17' - 18'	TRACKER	RIGHT	9662N	(*)	
SPORTSTER 883 IRON (XL883N/17)	17' - 18'	TRACKER	LEFT	9662N	(*)	
SPORTSTER 883 IRON (XL883N/17)	17' - 18'	GRAND TRACKER	RIGHT	9662N	(*)	
SPORTSTER 883 IRON (XL883N/17)	17' - 18'	GRAND TRACKER	LEFT	9662N	(*)	
SPORTSTER 883 SUPERLOW (XL883L)	11' - 13'	HI-TECH IV	RIGHT	9662N	(*)	
SPORTSTER 883 SUPERLOW (XL883L)	11' - 13'	HI-TECH IV	LEFT	9662N	(*)	
SPORTSTER 883 SUPERLOW (XL883L)	11' - 13'	MP	RIGHT	9662N	(*)	
SPORTSTER 883 SUPERLOW (XL883L)	11' - 13'	MP	LEFT	9662N	(*)	
SPORTSTER 883 SUPERLOW (XL883L)	11' - 13'	TRACKER	RIGHT	9662N	(*)	
SPORTSTER 883 SUPERLOW (XL883L)	11' - 13'	TRACKER	LEFT	9662N	(*)	
SPORTSTER 883 SUPERLOW (XL883L)	11' - 13'	GRAND TRACKER	RIGHT	9662N	(*)	
SPORTSTER 883 SUPERLOW (XL883L)	11' - 13'	GRAND TRACKER	LEFT	9662N	(*)	
SPORTSTER 883 SUPERLOW (XL883L)	14' - 16'	HI-TECH IV	RIGHT	9662N	(*)	



N
Black

P
Silver

(*) Check price with your distributor.

IMPORTANT: Indicate code color after part#. Example: 0973A.

ADAPTORS TO BAR END REARVIEW MIRRORS

HI-TECH PARTS | TYPE OF REAR MIRROR:

2019
MODELS:
www.puig.tv



GRAND TRACKER

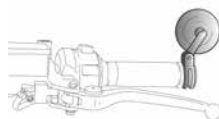

TRACKER



HI-TECH IV

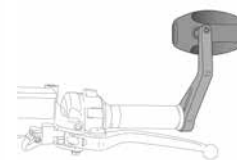

MP

MODEL	YEAR	TYPE OF REAR MIRROR	SIDE	REF. ADAPTOR	N	P
SPORTSTER 883 SUPERLOW (XL883L)	14' - 16'	HI-TECH IV	LEFT	9662N	(*)	
SPORTSTER 883 SUPERLOW (XL883L)	14' - 16'	MP	RIGHT	9662N	(*)	
SPORTSTER 883 SUPERLOW (XL883L)	14' - 16'	MP	LEFT	9662N	(*)	
SPORTSTER 883 SUPERLOW (XL883L)	14' - 16'	TRACKER	RIGHT	9662N	(*)	
SPORTSTER 883 SUPERLOW (XL883L)	14' - 16'	TRACKER	LEFT	9662N	(*)	
SPORTSTER 883 SUPERLOW (XL883L)	14' - 16'	GRAND TRACKER	RIGHT	9662N	(*)	
SPORTSTER 883 SUPERLOW (XL883L)	14' - 16'	GRAND TRACKER	LEFT	9662N	(*)	
SPORTSTER 883 SUPERLOW (XL883L/17)	17' - 18'	HI-TECH IV	RIGHT	9662N	(*)	
SPORTSTER 883 SUPERLOW (XL883L/17)	17' - 18'	HI-TECH IV	LEFT	9662N	(*)	
SPORTSTER 883 SUPERLOW (XL883L/17)	17' - 18'	MP	RIGHT	9662N	(*)	
SPORTSTER 883 SUPERLOW (XL883L/17)	17' - 18'	MP	LEFT	9662N	(*)	
SPORTSTER 883 SUPERLOW (XL883L/17)	17' - 18'	TRACKER	RIGHT	9662N	(*)	
SPORTSTER 883 SUPERLOW (XL883L/17)	17' - 18'	TRACKER	LEFT	9662N	(*)	
SPORTSTER 883 SUPERLOW (XL883L/17)	17' - 18'	GRAND TRACKER	RIGHT	9662N	(*)	
SPORTSTER 883 SUPERLOW (XL883L/17)	17' - 18'	GRAND TRACKER	LEFT	9662N	(*)	
SPORTSTER 883R ROADSTER (XL883R/06)	06'-13'	HI-TECH IV	RIGHT	9662N	(*)	
SPORTSTER 883R ROADSTER (XL883R/06)	06'-13'	HI-TECH IV	LEFT	9662N	(*)	
SPORTSTER 883R ROADSTER (XL883R/06)	06'-13'	MP	RIGHT	9662N	(*)	
SPORTSTER 883R ROADSTER (XL883R/06)	06'-13'	MP	LEFT	9662N	(*)	
SPORTSTER 883R ROADSTER (XL883R/06)	06'-13'	TRACKER	RIGHT	9662N	(*)	
SPORTSTER 883R ROADSTER (XL883R/06)	06'-13'	TRACKER	LEFT	9662N	(*)	
SPORTSTER 883R ROADSTER (XL883R/06)	06'-13'	GRAND TRACKER	RIGHT	9662N	(*)	
SPORTSTER 883R ROADSTER (XL883R/06)	06'-13'	GRAND TRACKER	LEFT	9662N	(*)	
SPORTSTER 883R ROADSTER (XL883R/06)	14'-18'	HI-TECH IV	RIGHT	9662N	(*)	
SPORTSTER 883R ROADSTER (XL883R/06)	14'-18'	HI-TECH IV	LEFT	9662N	(*)	
SPORTSTER 883R ROADSTER (XL883R/06)	14'-18'	MP	RIGHT	9662N	(*)	
SPORTSTER 883R ROADSTER (XL883R/06)	14'-18'	MP	LEFT	9662N	(*)	
SPORTSTER 883R ROADSTER (XL883R/06)	14'-18'	TRACKER	RIGHT	9662N	(*)	
SPORTSTER 883R ROADSTER (XL883R/06)	14'-18'	TRACKER	LEFT	9662N	(*)	
SPORTSTER 883R ROADSTER (XL883R/06)	14'-18'	GRAND TRACKER	RIGHT	9662N	(*)	
SPORTSTER 883R ROADSTER (XL883R/06)	14'-18'	GRAND TRACKER	LEFT	9662N	(*)	
SPORTSTER 1200 CUSTOM (XL1200C/11)	11'-13'	HI-TECH IV	RIGHT	9662N	(*)	
SPORTSTER 1200 CUSTOM (XL1200C/11)	11'-13'	HI-TECH IV	LEFT	9662N	(*)	
SPORTSTER 1200 CUSTOM (XL1200C/11)	11'-13'	MP	RIGHT	9662N	(*)	
SPORTSTER 1200 CUSTOM (XL1200C/11)	11'-13'	MP	LEFT	9662N	(*)	
SPORTSTER 1200 CUSTOM (XL1200C/11)	11'-13'	TRACKER	RIGHT	9662N	(*)	
SPORTSTER 1200 CUSTOM (XL1200C/11)	11'-13'	TRACKER	LEFT	9662N	(*)	
SPORTSTER 1200 CUSTOM (XL1200C/11)	11'-13'	GRAND TRACKER	RIGHT	9662N	(*)	
SPORTSTER 1200 CUSTOM (XL1200C/11)	11'-13'	GRAND TRACKER	LEFT	9662N	(*)	
SPORTSTER 1200 CUSTOM (XL1200C/11)	14'-16'	HI-TECH IV	RIGHT	9662N	(*)	

MODEL	YEAR	TYPE OF REAR MIRROR	SIDE	REF. ADAPTOR	N	P
SPORTSTER 1200 CUSTOM (XL1200C/11)	14'-16'	HI-TECH IV	LEFT	9662N	(*)	
SPORTSTER 1200 CUSTOM (XL1200C/11)	14'-16'	MP	RIGHT	9662N	(*)	
SPORTSTER 1200 CUSTOM (XL1200C/11)	14'-16'	MP	LEFT	9662N	(*)	
SPORTSTER 1200 CUSTOM (XL1200C/11)	14'-16'	TRACKER	RIGHT	9662N	(*)	
SPORTSTER 1200 CUSTOM (XL1200C/11)	14'-16'	TRACKER	LEFT	9662N	(*)	
SPORTSTER 1200 CUSTOM (XL1200C/11)	14'-16'	GRAND TRACKER	RIGHT	9662N	(*)	
SPORTSTER 1200 CUSTOM (XL1200C/11)	14'-16'	GRAND TRACKER	LEFT	9662N	(*)	
SPORTSTER 1200 CUSTOM (XL1200C/17)	17' - 18'	HI-TECH IV	RIGHT	9662N	(*)	
SPORTSTER 1200 CUSTOM (XL1200C/17)	17' - 18'	HI-TECH IV	LEFT	9662N	(*)	
SPORTSTER 1200 CUSTOM (XL1200C/17)	17' - 18'	MP	RIGHT	9662N	(*)	
SPORTSTER 1200 CUSTOM (XL1200C/17)	17' - 18'	MP	LEFT	9662N	(*)	
SPORTSTER 1200 CUSTOM (XL1200C/17)	17' - 18'	TRACKER	RIGHT	9662N	(*)	
SPORTSTER 1200 CUSTOM (XL1200C/17)	17' - 18'	TRACKER	LEFT	9662N	(*)	
SPORTSTER 1200 CUSTOM (XL1200C/17)	17' - 18'	GRAND TRACKER	RIGHT	9662N	(*)	
SPORTSTER 1200 CUSTOM (XL1200C/17)	17' - 18'	GRAND TRACKER	LEFT	9662N	(*)	
SPORTSTER 1200 SUPER LOW (XL1200T)	14'-16'	HI-TECH IV	RIGHT	9662N	(*)	
SPORTSTER 1200 SUPER LOW (XL1200T)	14'-16'	HI-TECH IV	LEFT	9662N	(*)	
SPORTSTER 1200 SUPER LOW (XL1200T)	14'-16'	MP	RIGHT	9662N	(*)	
SPORTSTER 1200 SUPER LOW (XL1200T)	14'-16'	MP	LEFT	9662N	(*)	
SPORTSTER 1200 SUPER LOW (XL1200T)	14'-16'	TRACKER	RIGHT	9662N	(*)	
SPORTSTER 1200 SUPER LOW (XL1200T)	14'-16'	TRACKER	LEFT	9662N	(*)	
SPORTSTER 1200 SUPER LOW (XL1200T)	14'-16'	GRAND TRACKER	RIGHT	9662N	(*)	
SPORTSTER 1200 SUPER LOW (XL1200T)	14'-16'	GRAND TRACKER	LEFT	9662N	(*)	
SPORTSTER 1200 SUPER LOW (XL1200T/17)	17' - 18'	HI-TECH IV	RIGHT	9662N	(*)	
SPORTSTER 1200 SUPER LOW (XL1200T/17)	17' - 18'	HI-TECH IV	LEFT	9662N	(*)	
SPORTSTER 1200 SUPER LOW (XL1200T/17)	17' - 18'	MP	RIGHT	9662N	(*)	
SPORTSTER 1200 SUPER LOW (XL1200T/17)	17' - 18'	MP	LEFT	9662N	(*)	
SPORTSTER 1200 SUPER LOW (XL1200T/17)	17' - 18'	TRACKER	RIGHT	9662N	(*)	
SPORTSTER 1200 SUPER LOW (XL1200T/17)	17' - 18'	TRACKER	LEFT	9662N	(*)	
SPORTSTER 1200 SUPER LOW (XL1200T/17)	17' - 18'	GRAND TRACKER	RIGHT	9662N	(*)	
SPORTSTER 1200 SUPER LOW (XL1200T/17)	17' - 18'	GRAND TRACKER	LEFT	9662N	(*)	
SPORTSTER 1200 ROADSTER (XL1200CX)	16'-18'	HI-TECH IV	RIGHT	9662N	(*)	
SPORTSTER 1200 ROADSTER (XL1200CX)	16'-18'	HI-TECH IV	LEFT	9662N	(*)	
SPORTSTER 1200 ROADSTER (XL1200CX)	16'-18'	MP	RIGHT	9662N	(*)	
SPORTSTER 1200 ROADSTER (XL1200CX)	16'-18'	MP	LEFT	9662N	(*)	
SPORTSTER 1200 ROADSTER (XL1200CX)	16'-18'	TRACKER	RIGHT	9662N	(*)	
SPORTSTER 1200 ROADSTER (XL1200CX)	16'-18'	TRACKER	LEFT	9662N	(*)	
SPORTSTER 1200 ROADSTER (XL1200CX)	16'-18'	GRAND TRACKER	RIGHT	9662N	(*)	
SPORTSTER 1200 ROADSTER (XL1200CX)	16'-18'	GRAND TRACKER	LEFT	9662N	(*)	
HONDA						
CB125F	15-18'	HI-TECH IV	RIGHT	UNIVERSAL - IT DOES NOT REQUIRE ADAPTOR		
CB125F	15-18'	HI-TECH IV	LEFT	UNIVERSAL - IT DOES NOT REQUIRE ADAPTOR		
CB125F	15-18'	MP	RIGHT	UNIVERSAL - IT DOES NOT REQUIRE ADAPTOR		
CB125F	15-18'	MP	LEFT	UNIVERSAL - IT DOES NOT REQUIRE ADAPTOR		



N
Black

P
Silver

(*) Check price with your distributor.

IMPORTANT: Indicate code color after part#. Example: 0973A.

ADAPTORS TO BAR END REARVIEW MIRRORS

HI-TECH PARTS | TYPE OF REAR MIRROR:

2019
MODELS:
www.puig.tv



GRAND TRACKER

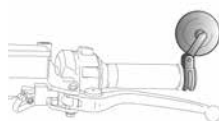

TRACKER



HI-TECH IV

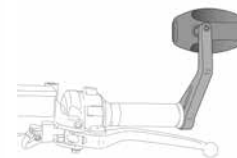

MP

MODEL	YEAR	TYPE OF REAR MIRROR	SIDE	REF. ADAPTOR	N	P
CB125F	15-18'	TRACKER	RIGHT	UNIVERSAL - IT DOES NOT REQUIRE ADAPTOR		
CB125F	15-18'	TRACKER	LEFT	UNIVERSAL - IT DOES NOT REQUIRE ADAPTOR		
CB125F	15-18'	GRAND TRACKER	RIGHT	UNIVERSAL - IT DOES NOT REQUIRE ADAPTOR		
CB125F	15-18'	GRAND TRACKER	LEFT	UNIVERSAL - IT DOES NOT REQUIRE ADAPTOR		
CB125R NEO SPORTS CAFE	18'	HI-TECH IV	RIGHT	UNIVERSAL - IT DOES NOT REQUIRE ADAPTOR		
CB125R NEO SPORTS CAFE	18'	HI-TECH IV	LEFT	UNIVERSAL - IT DOES NOT REQUIRE ADAPTOR		
CB125R NEO SPORTS CAFE	18'	MP	RIGHT	UNIVERSAL - IT DOES NOT REQUIRE ADAPTOR		
CB125R NEO SPORTS CAFE	18'	MP	LEFT	UNIVERSAL - IT DOES NOT REQUIRE ADAPTOR		
CB125R NEO SPORTS CAFE	18'	TRACKER	RIGHT	UNIVERSAL - IT DOES NOT REQUIRE ADAPTOR		
CB125R NEO SPORTS CAFE	18'	TRACKER	LEFT	UNIVERSAL - IT DOES NOT REQUIRE ADAPTOR		
CB125R NEO SPORTS CAFE	18'	GRAND TRACKER	RIGHT	UNIVERSAL - IT DOES NOT REQUIRE ADAPTOR		
CB125R NEO SPORTS CAFE	18'	GRAND TRACKER	LEFT	UNIVERSAL - IT DOES NOT REQUIRE ADAPTOR		
CB300R NEO SPORTS CAFE	18'	HI-TECH IV	RIGHT	UNIVERSAL - IT DOES NOT REQUIRE ADAPTOR		
CB300R NEO SPORTS CAFE	18'	HI-TECH IV	LEFT	UNIVERSAL - IT DOES NOT REQUIRE ADAPTOR		
CB300R NEO SPORTS CAFE	18'	MP	RIGHT	UNIVERSAL - IT DOES NOT REQUIRE ADAPTOR		
CB300R NEO SPORTS CAFE	18'	MP	LEFT	UNIVERSAL - IT DOES NOT REQUIRE ADAPTOR		
CB300R NEO SPORTS CAFE	18'	TRACKER	RIGHT	UNIVERSAL - IT DOES NOT REQUIRE ADAPTOR		
CB300R NEO SPORTS CAFE	18'	TRACKER	LEFT	UNIVERSAL - IT DOES NOT REQUIRE ADAPTOR		
CB300R NEO SPORTS CAFE	18'	GRAND TRACKER	RIGHT	UNIVERSAL - IT DOES NOT REQUIRE ADAPTOR		
CB300R NEO SPORTS CAFE	18'	GRAND TRACKER	LEFT	UNIVERSAL - IT DOES NOT REQUIRE ADAPTOR		
CB1000R NEO SPORTS CAFE	18'	HI-TECH IV	RIGHT	UNIVERSAL - IT DOES NOT REQUIRE ADAPTOR		
CB1000R NEO SPORTS CAFE	18'	HI-TECH IV	LEFT	UNIVERSAL - IT DOES NOT REQUIRE ADAPTOR		
CB1000R NEO SPORTS CAFE	18'	MP	RIGHT	UNIVERSAL - IT DOES NOT REQUIRE ADAPTOR		
CB1000R NEO SPORTS CAFE	18'	MP	LEFT	UNIVERSAL - IT DOES NOT REQUIRE ADAPTOR		
CB1000R NEO SPORTS CAFE	18'	TRACKER	RIGHT	UNIVERSAL - IT DOES NOT REQUIRE ADAPTOR		
CB1000R NEO SPORTS CAFE	18'	TRACKER	LEFT	UNIVERSAL - IT DOES NOT REQUIRE ADAPTOR		
CB1000R NEO SPORTS CAFE	18'	GRAND TRACKER	RIGHT	UNIVERSAL - IT DOES NOT REQUIRE ADAPTOR		
CB1000R NEO SPORTS CAFE	18'	GRAND TRACKER	LEFT	UNIVERSAL - IT DOES NOT REQUIRE ADAPTOR		
CB500	93-04'	HI-TECH IV	RIGHT	UNIVERSAL - IT DOES NOT REQUIRE ADAPTOR		
CB500	93-04'	HI-TECH IV	LEFT	UNIVERSAL - IT DOES NOT REQUIRE ADAPTOR		
CB500	93-04'	MP	RIGHT	UNIVERSAL - IT DOES NOT REQUIRE ADAPTOR		
CB500	93-04'	MP	LEFT	UNIVERSAL - IT DOES NOT REQUIRE ADAPTOR		
CB500	93-04'	TRACKER	RIGHT	UNIVERSAL - IT DOES NOT REQUIRE ADAPTOR		
CB500	93-04'	TRACKER	LEFT	UNIVERSAL - IT DOES NOT REQUIRE ADAPTOR		
CB500	93-04'	GRAND TRACKER	RIGHT	UNIVERSAL - IT DOES NOT REQUIRE ADAPTOR		
CB500	93-04'	GRAND TRACKER	LEFT	UNIVERSAL - IT DOES NOT REQUIRE ADAPTOR		
CB500F/X	13-18'	HI-TECH IV	RIGHT	UNIVERSAL - IT DOES NOT REQUIRE ADAPTOR		
CB500F/X	13-18'	HI-TECH IV	LEFT	UNIVERSAL - IT DOES NOT REQUIRE ADAPTOR		
CB500F/X	13-18'	MP	RIGHT	UNIVERSAL - IT DOES NOT REQUIRE ADAPTOR		
CB500F/X	13-18'	MP	LEFT	UNIVERSAL - IT DOES NOT REQUIRE ADAPTOR		

MODEL	YEAR	TYPE OF REAR MIRROR	SIDE	REF. ADAPTOR	N	P
CB500F/X	13-18'	TRACKER	RIGHT	UNIVERSAL - IT DOES NOT REQUIRE ADAPTOR		
CB500F/X	13-18'	TRACKER	LEFT	UNIVERSAL - IT DOES NOT REQUIRE ADAPTOR		
CB500F/X	13-18'	GRAND TRACKER	RIGHT	UNIVERSAL - IT DOES NOT REQUIRE ADAPTOR		
CB500F/X	13-18'	GRAND TRACKER	LEFT	UNIVERSAL - IT DOES NOT REQUIRE ADAPTOR		
CB600F HORNET	98-16'	HI-TECH IV	RIGHT	UNIVERSAL - IT DOES NOT REQUIRE ADAPTOR		
CB600F HORNET	98-16'	HI-TECH IV	LEFT	UNIVERSAL - IT DOES NOT REQUIRE ADAPTOR		
CB600F HORNET	98-16'	MP	RIGHT	UNIVERSAL - IT DOES NOT REQUIRE ADAPTOR		
CB600F HORNET	98-16'	MP	LEFT	UNIVERSAL - IT DOES NOT REQUIRE ADAPTOR		
CB600F HORNET	98-16'	TRACKER	RIGHT	UNIVERSAL - IT DOES NOT REQUIRE ADAPTOR		
CB600F HORNET	98-16'	TRACKER	LEFT	UNIVERSAL - IT DOES NOT REQUIRE ADAPTOR		
CB600F HORNET	98-16'	GRAND TRACKER	RIGHT	UNIVERSAL - IT DOES NOT REQUIRE ADAPTOR		
CB600F HORNET	98-16'	GRAND TRACKER	LEFT	UNIVERSAL - IT DOES NOT REQUIRE ADAPTOR		
CB650F	14-16'	HI-TECH IV	RIGHT	UNIVERSAL - IT DOES NOT REQUIRE ADAPTOR		
CB650F	14-16'	HI-TECH IV	LEFT	UNIVERSAL - IT DOES NOT REQUIRE ADAPTOR		
CB650F	14-16'	MP	RIGHT	UNIVERSAL - IT DOES NOT REQUIRE ADAPTOR		
CB650F	14-16'	MP	LEFT	UNIVERSAL - IT DOES NOT REQUIRE ADAPTOR		
CB650F	14-16'	TRACKER	RIGHT	UNIVERSAL - IT DOES NOT REQUIRE ADAPTOR		
CB650F	14-16'	TRACKER	LEFT	UNIVERSAL - IT DOES NOT REQUIRE ADAPTOR		
CB650F	14-16'	GRAND TRACKER	RIGHT	UNIVERSAL - IT DOES NOT REQUIRE ADAPTOR		
CB650F	14-16'	GRAND TRACKER	LEFT	UNIVERSAL - IT DOES NOT REQUIRE ADAPTOR		
CB750	93-03	HI-TECH IV	RIGHT	UNIVERSAL - IT DOES NOT REQUIRE ADAPTOR		
CB750	93-03	HI-TECH IV	LEFT	UNIVERSAL - IT DOES NOT REQUIRE ADAPTOR		
CB750	93-03	MP	RIGHT	UNIVERSAL - IT DOES NOT REQUIRE ADAPTOR		
CB750	93-03	MP	LEFT	UNIVERSAL - IT DOES NOT REQUIRE ADAPTOR		
CB750	93-03	TRACKER	RIGHT	UNIVERSAL - IT DOES NOT REQUIRE ADAPTOR		
CB750	93-03	TRACKER	LEFT	UNIVERSAL - IT DOES NOT REQUIRE ADAPTOR		
CB750	93-03	GRAND TRACKER	RIGHT	UNIVERSAL - IT DOES NOT REQUIRE ADAPTOR		
CB750	93-03	GRAND TRACKER	LEFT	UNIVERSAL - IT DOES NOT REQUIRE ADAPTOR		
CB900F HORNET	02-05'	HI-TECH IV	RIGHT	UNIVERSAL - IT DOES NOT REQUIRE ADAPTOR		
CB900F HORNET	02-05'	HI-TECH IV	LEFT	UNIVERSAL - IT DOES NOT REQUIRE ADAPTOR		
CB900F HORNET	02-05'	MP	RIGHT	UNIVERSAL - IT DOES NOT REQUIRE ADAPTOR		
CB900F HORNET	02-05'	MP	LEFT	UNIVERSAL - IT DOES NOT REQUIRE ADAPTOR		
CB900F HORNET	02-05'	TRACKER	RIGHT	UNIVERSAL - IT DOES NOT REQUIRE ADAPTOR		
CB900F HORNET	02-05'	TRACKER	LEFT	UNIVERSAL - IT DOES NOT REQUIRE ADAPTOR		
CB900F HORNET	02-05'	GRAND TRACKER	RIGHT	UNIVERSAL - IT DOES NOT REQUIRE ADAPTOR		
CB900F HORNET	02-05'	GRAND TRACKER	LEFT	UNIVERSAL - IT DOES NOT REQUIRE ADAPTOR		
CB1000R	08-16'	HI-TECH IV	RIGHT	UNIVERSAL - IT DOES NOT REQUIRE ADAPTOR		
CB1000R	08-16'	HI-TECH IV	LEFT	UNIVERSAL - IT DOES NOT REQUIRE ADAPTOR		
CB1000R	08-16'	MP	RIGHT	UNIVERSAL - IT DOES NOT REQUIRE ADAPTOR		
CB1000R	08-16'	MP	LEFT	UNIVERSAL - IT DOES NOT REQUIRE ADAPTOR		
CB1000R	08-16'	TRACKER	RIGHT	UNIVERSAL - IT DOES NOT REQUIRE ADAPTOR		
CB1000R	08-16'	TRACKER	LEFT	UNIVERSAL - IT DOES NOT REQUIRE ADAPTOR		
CB1000R	08-16'	GRAND TRACKER	RIGHT	UNIVERSAL - IT DOES NOT REQUIRE ADAPTOR		
CB1000R	08-16'	GRAND TRACKER	LEFT	UNIVERSAL - IT DOES NOT REQUIRE ADAPTOR		



N
Black

P
Silver

(*) Check price with your distributor.

IMPORTANT: Indicate code color after part#. Example: 0973A.

ADAPTORS TO BAR END REARVIEW MIRRORS

HI-TECH PARTS | TYPE OF REAR MIRROR:

2019
MODELS:
www.puig.tv



GRAND TRACKER

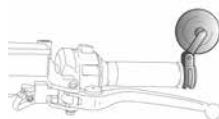

TRACKER



HI-TECH IV

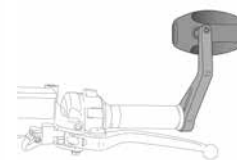

MP

MODEL	YEAR	TYPE OF REAR MIRROR	SIDE	REF. ADAPTOR	N	P
CB1100EX/RS	17'-18'	HI-TECH IV	RIGHT	UNIVERSAL - IT DOES NOT REQUIRE ADAPTOR		
CB1100EX/RS	17'-18'	HI-TECH IV	LEFT	UNIVERSAL - IT DOES NOT REQUIRE ADAPTOR		
CB1100EX/RS	17'-18'	MP	RIGHT	UNIVERSAL - IT DOES NOT REQUIRE ADAPTOR		
CB1100EX/RS	17'-18'	MP	LEFT	UNIVERSAL - IT DOES NOT REQUIRE ADAPTOR		
CB1100EX/RS	17'-18'	TRACKER	RIGHT	UNIVERSAL - IT DOES NOT REQUIRE ADAPTOR		
CB1100EX/RS	17'-18'	TRACKER	LEFT	UNIVERSAL - IT DOES NOT REQUIRE ADAPTOR		
CB1100EX/RS	17'-18'	GRAND TRACKER	RIGHT	UNIVERSAL - IT DOES NOT REQUIRE ADAPTOR		
CB1100EX/RS	17'-18'	GRAND TRACKER	LEFT	UNIVERSAL - IT DOES NOT REQUIRE ADAPTOR		
CB1300	03'	HI-TECH IV	RIGHT	UNIVERSAL - IT DOES NOT REQUIRE ADAPTOR		
CB1300	03'	HI-TECH IV	LEFT	UNIVERSAL - IT DOES NOT REQUIRE ADAPTOR		
CB1300	03'	MP	RIGHT	UNIVERSAL - IT DOES NOT REQUIRE ADAPTOR		
CB1300	03'	MP	LEFT	UNIVERSAL - IT DOES NOT REQUIRE ADAPTOR		
CB1300	03'	TRACKER	RIGHT	UNIVERSAL - IT DOES NOT REQUIRE ADAPTOR		
CB1300	03'	TRACKER	LEFT	UNIVERSAL - IT DOES NOT REQUIRE ADAPTOR		
CB1300	03'	GRAND TRACKER	RIGHT	UNIVERSAL - IT DOES NOT REQUIRE ADAPTOR		
CB1300	03'	GRAND TRACKER	LEFT	UNIVERSAL - IT DOES NOT REQUIRE ADAPTOR		
CBF250	04-16'	HI-TECH IV	RIGHT	UNIVERSAL - IT DOES NOT REQUIRE ADAPTOR		
CBF250	04-16'	HI-TECH IV	LEFT	UNIVERSAL - IT DOES NOT REQUIRE ADAPTOR		
CBF250	04-16'	MP	RIGHT	UNIVERSAL - IT DOES NOT REQUIRE ADAPTOR		
CBF250	04-16'	MP	LEFT	UNIVERSAL - IT DOES NOT REQUIRE ADAPTOR		
CBF250	04-16'	TRACKER	RIGHT	UNIVERSAL - IT DOES NOT REQUIRE ADAPTOR		
CBF250	04-16'	TRACKER	LEFT	UNIVERSAL - IT DOES NOT REQUIRE ADAPTOR		
CBF250	04-16'	GRAND TRACKER	RIGHT	UNIVERSAL - IT DOES NOT REQUIRE ADAPTOR		
CBF250	04-16'	GRAND TRACKER	LEFT	UNIVERSAL - IT DOES NOT REQUIRE ADAPTOR		
CBF500	04-07'	HI-TECH IV	RIGHT	UNIVERSAL - IT DOES NOT REQUIRE ADAPTOR		
CBF500	04-07'	HI-TECH IV	LEFT	UNIVERSAL - IT DOES NOT REQUIRE ADAPTOR		
CBF500	04-07'	MP	RIGHT	UNIVERSAL - IT DOES NOT REQUIRE ADAPTOR		
CBF500	04-07'	MP	LEFT	UNIVERSAL - IT DOES NOT REQUIRE ADAPTOR		
CBF500	04-07'	TRACKER	RIGHT	UNIVERSAL - IT DOES NOT REQUIRE ADAPTOR		
CBF500	04-07'	TRACKER	LEFT	UNIVERSAL - IT DOES NOT REQUIRE ADAPTOR		
CBF500	04-07'	GRAND TRACKER	RIGHT	UNIVERSAL - IT DOES NOT REQUIRE ADAPTOR		
CBF500	04-07'	GRAND TRACKER	LEFT	UNIVERSAL - IT DOES NOT REQUIRE ADAPTOR		
CBF600	04-14'	HI-TECH IV	RIGHT	UNIVERSAL - IT DOES NOT REQUIRE ADAPTOR		
CBF600	04-14'	HI-TECH IV	LEFT	UNIVERSAL - IT DOES NOT REQUIRE ADAPTOR		
CBF600	04-14'	MP	RIGHT	UNIVERSAL - IT DOES NOT REQUIRE ADAPTOR		
CBF600	04-14'	MP	LEFT	UNIVERSAL - IT DOES NOT REQUIRE ADAPTOR		
CBF600	04-14'	TRACKER	RIGHT	UNIVERSAL - IT DOES NOT REQUIRE ADAPTOR		
CBF600	04-14'	TRACKER	LEFT	UNIVERSAL - IT DOES NOT REQUIRE ADAPTOR		
CBF600	04-14'	GRAND TRACKER	RIGHT	UNIVERSAL - IT DOES NOT REQUIRE ADAPTOR		
CBF600	04-14'	GRAND TRACKER	LEFT	UNIVERSAL - IT DOES NOT REQUIRE ADAPTOR		

MODEL	YEAR	TYPE OF REAR MIRROR	SIDE	REF. ADAPTOR	N	P
INTEGRA 700	12-13'	HI-TECH IV	RIGHT	UNIVERSAL - IT DOES NOT REQUIRE ADAPTOR		
INTEGRA 700	12-13'	HI-TECH IV	LEFT	UNIVERSAL - IT DOES NOT REQUIRE ADAPTOR		
INTEGRA 700	12-13'	MP	RIGHT	UNIVERSAL - IT DOES NOT REQUIRE ADAPTOR		
INTEGRA 700	12-13'	MP	LEFT	UNIVERSAL - IT DOES NOT REQUIRE ADAPTOR		
INTEGRA 700	12-13'	TRACKER	RIGHT	UNIVERSAL - IT DOES NOT REQUIRE ADAPTOR		
INTEGRA 700	12-13'	TRACKER	LEFT	UNIVERSAL - IT DOES NOT REQUIRE ADAPTOR		
INTEGRA 700	12-13'	GRAND TRACKER	RIGHT	UNIVERSAL - IT DOES NOT REQUIRE ADAPTOR		
INTEGRA 700	12-13'	GRAND TRACKER	LEFT	UNIVERSAL - IT DOES NOT REQUIRE ADAPTOR		
INTEGRA 750	14-18'	HI-TECH IV	RIGHT	UNIVERSAL - IT DOES NOT REQUIRE ADAPTOR		
INTEGRA 750	14-18'	HI-TECH IV	LEFT	UNIVERSAL - IT DOES NOT REQUIRE ADAPTOR		
INTEGRA 750	14-18'	MP	RIGHT	UNIVERSAL - IT DOES NOT REQUIRE ADAPTOR		
INTEGRA 750	14-18'	MP	LEFT	UNIVERSAL - IT DOES NOT REQUIRE ADAPTOR		
INTEGRA 750	14-18'	TRACKER	RIGHT	UNIVERSAL - IT DOES NOT REQUIRE ADAPTOR		
INTEGRA 750	14-18'	TRACKER	LEFT	UNIVERSAL - IT DOES NOT REQUIRE ADAPTOR		
INTEGRA 750	14-18'	GRAND TRACKER	RIGHT	UNIVERSAL - IT DOES NOT REQUIRE ADAPTOR		
INTEGRA 750	14-18'	GRAND TRACKER	LEFT	UNIVERSAL - IT DOES NOT REQUIRE ADAPTOR		
NC700 S/X	12-13'	HI-TECH IV	RIGHT	UNIVERSAL - IT DOES NOT REQUIRE ADAPTOR		
NC700 S/X	12-13'	HI-TECH IV	LEFT	UNIVERSAL - IT DOES NOT REQUIRE ADAPTOR		
NC700 S/X	12-13'	MP	RIGHT	UNIVERSAL - IT DOES NOT REQUIRE ADAPTOR		
NC700 S/X	12-13'	MP	LEFT	UNIVERSAL - IT DOES NOT REQUIRE ADAPTOR		
NC700 S/X	12-13'	TRACKER	RIGHT	UNIVERSAL - IT DOES NOT REQUIRE ADAPTOR		
NC700 S/X	12-13'	TRACKER	LEFT	UNIVERSAL - IT DOES NOT REQUIRE ADAPTOR		
NC700 S/X	12-13'	GRAND TRACKER	RIGHT	UNIVERSAL - IT DOES NOT REQUIRE ADAPTOR		
NC700 S/X	12-13'	GRAND TRACKER	LEFT	UNIVERSAL - IT DOES NOT REQUIRE ADAPTOR		
NC750 S/X	14-18'	HI-TECH IV	RIGHT	UNIVERSAL - IT DOES NOT REQUIRE ADAPTOR		
NC750 S/X	14-18'	HI-TECH IV	LEFT	UNIVERSAL - IT DOES NOT REQUIRE ADAPTOR		
NC750 S/X	14-18'	MP	RIGHT	UNIVERSAL - IT DOES NOT REQUIRE ADAPTOR		
NC750 S/X	14-18'	MP	LEFT	UNIVERSAL - IT DOES NOT REQUIRE ADAPTOR		
NC750 S/X	14-18'	TRACKER	RIGHT	UNIVERSAL - IT DOES NOT REQUIRE ADAPTOR		
NC750 S/X	14-18'	TRACKER	LEFT	UNIVERSAL - IT DOES NOT REQUIRE ADAPTOR		
NC750 S/X	14-18'	GRAND TRACKER	RIGHT	UNIVERSAL - IT DOES NOT REQUIRE ADAPTOR		
NC750 S/X	14-18'	GRAND TRACKER	LEFT	UNIVERSAL - IT DOES NOT REQUIRE ADAPTOR		
MSX125	14-18'	HI-TECH IV	RIGHT	UNIVERSAL - IT DOES NOT REQUIRE ADAPTOR		
MSX125	14-18'	HI-TECH IV	LEFT	UNIVERSAL - IT DOES NOT REQUIRE ADAPTOR		
MSX125	14-18'	MP	RIGHT	UNIVERSAL - IT DOES NOT REQUIRE ADAPTOR		
MSX125	14-18'	MP	LEFT	UNIVERSAL - IT DOES NOT REQUIRE ADAPTOR		
MSX125	14-18'	TRACKER	RIGHT	UNIVERSAL - IT DOES NOT REQUIRE ADAPTOR		
MSX125	14-18'	TRACKER	LEFT	UNIVERSAL - IT DOES NOT REQUIRE ADAPTOR		
MSX125	14-18'	GRAND TRACKER	RIGHT	UNIVERSAL - IT DOES NOT REQUIRE ADAPTOR		
MSX125	14-18'	GRAND TRACKER	LEFT	UNIVERSAL - IT DOES NOT REQUIRE ADAPTOR		
CB1100/RS/EX		HI-TECH IV	RIGHT	CHECK WEB		
CB1100/RS/EX		HI-TECH IV	LEFT	CHECK WEB		
CB1100/RS/EX		MP	RIGHT	CHECK WEB		
CB1100/RS/EX		MP	LEFT	CHECK WEB		



N
Black

P
Silver

(*) Check price with your distributor.

IMPORTANT: Indicate code color after part#. Example: 0973A.

ADAPTORS TO BAR END REARVIEW MIRRORS

HI-TECH PARTS | TYPE OF REAR MIRROR:

2019
 MODELS:
www.puig.tv



GRAND TRACKER



TRACKER



HI-TECH IV

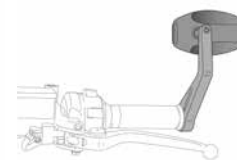

MP

MODEL	YEAR	TYPE OF REAR MIRROR	SIDE	REF. ADAPTOR	N	P
CB1100/RS/EX		TRACKER	RIGHT		CHECK WEB	
CB1100/RS/EX		TRACKER	LEFT		CHECK WEB	
CB1100/RS/EX		GRAND TRACKER	RIGHT		CHECK WEB	
CB1100/RS/EX		GRAND TRACKER	LEFT		CHECK WEB	
CBR1000RR FIREBLADE/SP/SP2	17' - 18'	HI-TECH IV	RIGHT	UNIVERSAL - IT DOES NOT REQUIRE ADAPTOR		
CBR1000RR FIREBLADE/SP/SP2	17' - 18'	HI-TECH IV	LEFT	UNIVERSAL - IT DOES NOT REQUIRE ADAPTOR		
CBR1000RR FIREBLADE/SP/SP2	17' - 18'	MP	RIGHT	UNIVERSAL - IT DOES NOT REQUIRE ADAPTOR		
CBR1000RR FIREBLADE/SP/SP2	17' - 18'	MP	LEFT	UNIVERSAL - IT DOES NOT REQUIRE ADAPTOR		
CBR1000RR FIREBLADE/SP/SP2	17' - 18'	TRACKER	RIGHT	UNIVERSAL - IT DOES NOT REQUIRE ADAPTOR		
CBR1000RR FIREBLADE/SP/SP2	17' - 18'	TRACKER	LEFT	UNIVERSAL - IT DOES NOT REQUIRE ADAPTOR		
CBR1000RR FIREBLADE/SP/SP2	17' - 18'	GRAND TRACKER	RIGHT	UNIVERSAL - IT DOES NOT REQUIRE ADAPTOR		
CBR1000RR FIREBLADE/SP/SP2	17' - 18'	GRAND TRACKER	LEFT	UNIVERSAL - IT DOES NOT REQUIRE ADAPTOR		
INDIAN						
SCOUT BOBBER	18'	HI-TECH IV	RIGHT	9764N	(*)	
SCOUT BOBBER	18'	HI-TECH IV	LEFT	9764N	(*)	
SCOUT BOBBER	18'	MP	RIGHT	9764N	(*)	
SCOUT BOBBER	18'	MP	LEFT	9764N	(*)	
SCOUT BOBBER	18'	TRACKER	RIGHT	9764N	(*)	
SCOUT BOBBER	18'	TRACKER	LEFT	9764N	(*)	
SCOUT BOBBER	18'	GRAND TRACKER	RIGHT	9764N	(*)	
SCOUT BOBBER	18'	GRAND TRACKER	LEFT	9764N	(*)	
KAWASAKI						
ER-6N	05' - 16'	HI-TECH IV	RIGHT	9584N	(*)	
ER-6N	05' - 16'	HI-TECH IV	LEFT	9584N	(*)	
ER-6N	05' - 16'	MP	RIGHT	9584N	(*)	
ER-6N	05' - 16'	MP	LEFT	9584N	(*)	
ER-6N	05' - 16'	TRACKER	RIGHT	9584N	(*)	
ER-6N	05' - 16'	TRACKER	LEFT	9584N	(*)	
ER-6N	05' - 16'	GRAND TRACKER	RIGHT	9584N	(*)	
ER-6N	05' - 16'	GRAND TRACKER	LEFT	9584N	(*)	
VERSYS 650	07' - 18'	HI-TECH IV	RIGHT	9584N	(*)	
VERSYS 650	07' - 18'	HI-TECH IV	LEFT	9584N	(*)	
VERSYS 650	07' - 18'	MP	RIGHT	9584N	(*)	
VERSYS 650	07' - 18'	MP	LEFT	9584N	(*)	
VERSYS 650	07' - 18'	TRACKER	RIGHT	9584N	(*)	
VERSYS 650	07' - 18'	TRACKER	LEFT	9584N	(*)	
VERSYS 650	07' - 18'	GRAND TRACKER	RIGHT	9584N	(*)	
VERSYS 650	07' - 18'	GRAND TRACKER	LEFT	9584N	(*)	
Z300	15'-17'	HI-TECH IV	RIGHT	9584N	(*)	
Z300	15'-17'	HI-TECH IV	LEFT	9584N	(*)	

MODEL	YEAR	TYPE OF REAR MIRROR	SIDE	REF. ADAPTOR	N	P
Z300	15'-17'	MP	RIGHT	9584N	(*)	
Z300	15'-17'	MP	LEFT	9584N	(*)	
Z300	15'-17'	TRACKER	RIGHT	9584N	(*)	
Z300	15'-17'	TRACKER	LEFT	9584N	(*)	
Z300	15'-17'	GRAND TRACKER	RIGHT	9584N	(*)	
Z300	15'-17'	GRAND TRACKER	LEFT	9584N	(*)	
Z750	04' - 12'	HI-TECH IV	RIGHT	9584N	(*)	
Z750	04' - 12'	HI-TECH IV	LEFT	9584N	(*)	
Z750	04' - 12'	MP	RIGHT	9584N	(*)	
Z750	04' - 12'	MP	LEFT	9584N	(*)	
Z750	04' - 12'	TRACKER	RIGHT	9584N	(*)	
Z750	04' - 12'	TRACKER	LEFT	9584N	(*)	
Z750	04' - 12'	GRAND TRACKER	RIGHT	9584N	(*)	
Z750	04' - 12'	GRAND TRACKER	LEFT	9584N	(*)	
Z750R	11' - 12'	HI-TECH IV	RIGHT	9584N	(*)	
Z750R	11' - 12'	HI-TECH IV	LEFT	9584N	(*)	
Z750R	11' - 12'	MP	RIGHT	9584N	(*)	
Z750R	11' - 12'	MP	LEFT	9584N	(*)	
Z750R	11' - 12'	TRACKER	RIGHT	9584N	(*)	
Z750R	11' - 12'	TRACKER	LEFT	9584N	(*)	
Z750R	11' - 12'	GRAND TRACKER	RIGHT	9584N	(*)	
Z750R	11' - 12'	GRAND TRACKER	LEFT	9584N	(*)	
Z650	17' - 18'	HI-TECH IV	RIGHT	9584N	(*)	
Z650	17' - 18'	HI-TECH IV	LEFT	9584N	(*)	
Z650	17' - 18'	MP	RIGHT	9584N	(*)	
Z650	17' - 18'	MP	LEFT	9584N	(*)	
Z650	17' - 18'	TRACKER	RIGHT	9584N	(*)	
Z650	17' - 18'	TRACKER	LEFT	9584N	(*)	
Z650	17' - 18'	GRAND TRACKER	RIGHT	9584N	(*)	
Z650	17' - 18'	GRAND TRACKER	LEFT	9584N	(*)	
Z800/E	13' - 16'	HI-TECH IV	RIGHT	9584N	(*)	
Z800/E	13' - 16'	HI-TECH IV	LEFT	9584N	(*)	
Z800/E	13' - 16'	MP	RIGHT	9584N	(*)	
Z800/E	13' - 16'	MP	LEFT	9584N	(*)	
Z800/E	13' - 16'	TRACKER	RIGHT	9584N	(*)	
Z800/E	13' - 16'	TRACKER	LEFT	9584N	(*)	
Z800/E	13' - 16'	GRAND TRACKER	RIGHT	9584N	(*)	
Z800/E	13' - 16'	GRAND TRACKER	LEFT	9584N	(*)	
Z900	17' - 18'	HI-TECH IV	RIGHT	9584N	(*)	
Z900	17' - 18'	HI-TECH IV	LEFT	9584N	(*)	
Z900	17' - 18'	MP	RIGHT	9584N	(*)	
Z900	17' - 18'	MP	LEFT	9584N	(*)	
Z900	17' - 18'	TRACKER	RIGHT	9584N	(*)	
Z900	17' - 18'	TRACKER	LEFT	9584N	(*)	

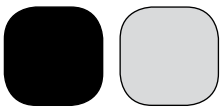

N
Black

P
Silver

(*) Check price with your distributor.

IMPORTANT: Indicate code color after part#. Example: 0973A.

ADAPTORS TO BAR END REARVIEW MIRRORS

HI-TECH PARTS | TYPE OF REAR MIRROR:

2019
MODELS:
www.puig.tv



GRAND TRACKER

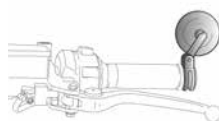

TRACKER



HI-TECH IV

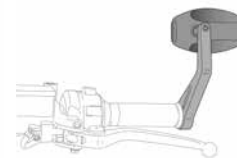

MP

MODEL	YEAR	TYPE OF REAR MIRROR	SIDE	REF. ADAPTOR	N	P
Z900	17' - 18'	GRAND TRACKER	RIGHT	9584N	(*)	
Z900	17' - 18'	GRAND TRACKER	LEFT	9584N	(*)	
Z900RS	18'	HI-TECH IV	RIGHT	9584N	(*)	
Z900RS	18'	HI-TECH IV	LEFT	9584N	(*)	
Z900RS	18'	MP	RIGHT	9584N	(*)	
Z900RS	18'	MP	LEFT	9584N	(*)	
Z900RS	18'	TRACKER	RIGHT	9584N	(*)	
Z900RS	18'	TRACKER	LEFT	9584N	(*)	
Z900RS	18'	GRAND TRACKER	RIGHT	9584N	(*)	
Z900RS	18'	GRAND TRACKER	LEFT	9584N	(*)	
VULCAN S	15' - 18'	HI-TECH IV	RIGHT	9584N	(*)	
VULCAN S	15' - 18'	HI-TECH IV	LEFT	9584N	(*)	
VULCAN S	15' - 18'	MP	RIGHT	9584N	(*)	
VULCAN S	15' - 18'	MP	RIGHT	9584N	(*)	
VULCAN S	15' - 18'	TRACKER	RIGHT	9584N	(*)	
VULCAN S	15' - 18'	TRACKER	RIGHT	9584N	(*)	
VULCAN S	15' - 18'	GRAND TRACKER	RIGHT	9584N	(*)	
VULCAN S	15' - 18'	GRAND TRACKER	LEFT	9584N	(*)	
VULCAN S CAFE	17' - 18'	HI-TECH IV	RIGHT	9584N	(*)	
VULCAN S CAFE	17' - 18'	HI-TECH IV	LEFT	9584N	(*)	
VULCAN S CAFE	17' - 18'	MP	RIGHT	9584N	(*)	
VULCAN S CAFE	17' - 18'	MP	RIGHT	9584N	(*)	
VULCAN S CAFE	17' - 18'	TRACKER	RIGHT	9584N	(*)	
VULCAN S CAFE	17' - 18'	TRACKER	RIGHT	9584N	(*)	
VULCAN S CAFE	17' - 18'	GRAND TRACKER	RIGHT	9584N	(*)	
VULCAN S CAFE	17' - 18'	GRAND TRACKER	LEFT	9584N	(*)	
W800	11' - 16'	HI-TECH IV	RIGHT	9584N	(*)	
W800	11' - 16'	HI-TECH IV	RIGHT	9584N	(*)	
W800	11' - 16'	MP	RIGHT	9584N	(*)	
W800	11' - 16'	MP	RIGHT	9584N	(*)	
W800	11' - 16'	TRACKER	RIGHT	9584N	(*)	
W800	11' - 16'	TRACKER	RIGHT	9584N	(*)	
W800	11' - 16'	GRAND TRACKER	RIGHT	9584N	(*)	
W800	11' - 16'	GRAND TRACKER	LEFT	9584N	(*)	
KTM						
125 DUKE	11' - 18'	HI-TECH IV	RIGHT	UNIVERSAL - IT DOES NOT REQUIRE ADAPTOR		
125 DUKE	11' - 18'	HI-TECH IV	LEFT	UNIVERSAL - IT DOES NOT REQUIRE ADAPTOR		
125 DUKE	11' - 18'	MP	RIGHT	UNIVERSAL - IT DOES NOT REQUIRE ADAPTOR		
125 DUKE	11' - 18'	MP	LEFT	UNIVERSAL - IT DOES NOT REQUIRE ADAPTOR		
125 DUKE	11' - 18'	TRACKER	RIGHT	UNIVERSAL - IT DOES NOT REQUIRE ADAPTOR		

MODEL	YEAR	TYPE OF REAR MIRROR	SIDE	REF. ADAPTOR	N	P
125 DUKE	11' - 18'	TRACKER	LEFT	UNIVERSAL - IT DOES NOT REQUIRE ADAPTOR		
125 DUKE	11' - 18'	GRAND TRACKER	RIGHT	UNIVERSAL - IT DOES NOT REQUIRE ADAPTOR		
125 DUKE	11' - 18'	GRAND TRACKER	LEFT	UNIVERSAL - IT DOES NOT REQUIRE ADAPTOR		
200 DUKE	12' - 15'	HI-TECH IV	RIGHT	UNIVERSAL - IT DOES NOT REQUIRE ADAPTOR		
200 DUKE	12' - 15'	HI-TECH IV	LEFT	UNIVERSAL - IT DOES NOT REQUIRE ADAPTOR		
200 DUKE	12' - 15'	MP	RIGHT	UNIVERSAL - IT DOES NOT REQUIRE ADAPTOR		
200 DUKE	12' - 15'	MP	LEFT	UNIVERSAL - IT DOES NOT REQUIRE ADAPTOR		
200 DUKE	12' - 15'	TRACKER	RIGHT	UNIVERSAL - IT DOES NOT REQUIRE ADAPTOR		
200 DUKE	12' - 15'	TRACKER	LEFT	UNIVERSAL - IT DOES NOT REQUIRE ADAPTOR		
200 DUKE	12' - 15'	GRAND TRACKER	RIGHT	UNIVERSAL - IT DOES NOT REQUIRE ADAPTOR		
200 DUKE	12' - 15'	GRAND TRACKER	LEFT	UNIVERSAL - IT DOES NOT REQUIRE ADAPTOR		
390 DUKE	13' - 18'	HI-TECH IV	RIGHT	UNIVERSAL - IT DOES NOT REQUIRE ADAPTOR		
390 DUKE	13' - 18'	HI-TECH IV	LEFT	UNIVERSAL - IT DOES NOT REQUIRE ADAPTOR		
390 DUKE	13' - 18'	MP	RIGHT	UNIVERSAL - IT DOES NOT REQUIRE ADAPTOR		
390 DUKE	13' - 18'	MP	LEFT	UNIVERSAL - IT DOES NOT REQUIRE ADAPTOR		
390 DUKE	13' - 18'	TRACKER	RIGHT	UNIVERSAL - IT DOES NOT REQUIRE ADAPTOR		
390 DUKE	13' - 18'	TRACKER	LEFT	UNIVERSAL - IT DOES NOT REQUIRE ADAPTOR		
390 DUKE	13' - 18'	GRAND TRACKER	RIGHT	UNIVERSAL - IT DOES NOT REQUIRE ADAPTOR		
390 DUKE	13' - 18'	GRAND TRACKER	LEFT	UNIVERSAL - IT DOES NOT REQUIRE ADAPTOR		
790 DUKE	18'	HI-TECH IV	RIGHT	UNIVERSAL - IT DOES NOT REQUIRE ADAPTOR		
790 DUKE	18'	HI-TECH IV	LEFT	UNIVERSAL - IT DOES NOT REQUIRE ADAPTOR		
790 DUKE	18'	MP	RIGHT	UNIVERSAL - IT DOES NOT REQUIRE ADAPTOR		
790 DUKE	18'	MP	LEFT	UNIVERSAL - IT DOES NOT REQUIRE ADAPTOR		
790 DUKE	18'	TRACKER	RIGHT	UNIVERSAL - IT DOES NOT REQUIRE ADAPTOR		
790 DUKE	18'	TRACKER	LEFT	UNIVERSAL - IT DOES NOT REQUIRE ADAPTOR		
790 DUKE	18'	GRAND TRACKER	RIGHT	UNIVERSAL - IT DOES NOT REQUIRE ADAPTOR		
790 DUKE	18'	GRAND TRACKER	LEFT	UNIVERSAL - IT DOES NOT REQUIRE ADAPTOR		
1290 SUPERDUKE R	14' - 18'	HI-TECH IV	RIGHT	UNIVERSAL - IT DOES NOT REQUIRE ADAPTOR		
1290 SUPERDUKE R	14' - 18'	HI-TECH IV	LEFT	UNIVERSAL - IT DOES NOT REQUIRE ADAPTOR		
1290 SUPERDUKE R	14' - 18'	MP	RIGHT	UNIVERSAL - IT DOES NOT REQUIRE ADAPTOR		
1290 SUPERDUKE R	14' - 18'	MP	LEFT	UNIVERSAL - IT DOES NOT REQUIRE ADAPTOR		
1290 SUPERDUKE R	14' - 18'	TRACKER	RIGHT	UNIVERSAL - IT DOES NOT REQUIRE ADAPTOR		
1290 SUPERDUKE R	14' - 18'	TRACKER	LEFT	UNIVERSAL - IT DOES NOT REQUIRE ADAPTOR		
1290 SUPERDUKE R	14' - 18'	GRAND TRACKER	RIGHT	UNIVERSAL - IT DOES NOT REQUIRE ADAPTOR		
1290 SUPERDUKE R	14' - 18'	GRAND TRACKER	LEFT	UNIVERSAL - IT DOES NOT REQUIRE ADAPTOR		
SUZUKI						
DL250 V-STROM	17' - 18'	HI-TECH IV	RIGHT	9582N	(*)	
DL250 V-STROM	17' - 18'	HI-TECH IV	LEFT	9582N	(*)	
DL250 V-STROM	17' - 18'	MP	RIGHT	9582N	(*)	
DL250 V-STROM	17' - 18'	MP	LEFT	9582N	(*)	
DL250 V-STROM	17' - 18'	TRACKER	RIGHT	9582N	(*)	
DL250 V-STROM	17' - 18'	TRACKER	LEFT	9582N	(*)	
DL250 V-STROM	17' - 18'	GRAND TRACKER	RIGHT	9582N	(*)	
DL250 V-STROM	17' - 18'	GRAND TRACKER	LEFT	9582N	(*)	



N
Black

P
Silver

(*) Check price with your distributor.

IMPORTANT: Indicate code color after part#. Example: 0973A.

ADAPTORS TO BAR END REARVIEW MIRRORS

HI-TECH PARTS | TYPE OF REAR MIRROR:

2019
MODELS:
www.puig.tv



GRAND TRACKER

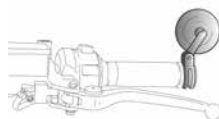

TRACKER



HI-TECH IV

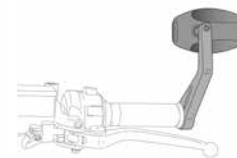

MP

MODEL	YEAR	TYPE OF REAR MIRROR	SIDE	REF. ADAPTOR	N	P
B-KING	08' - 11'	HI-TECH IV	RIGHT	9582N	(*)	
B-KING	08' - 11'	HI-TECH IV	LEFT	9582N	(*)	
B-KING	08' - 11'	MP	RIGHT	9582N	(*)	
B-KING	08' - 11'	MP	LEFT	9582N	(*)	
B-KING	08' - 11'	TRACKER	RIGHT	9582N	(*)	
B-KING	08' - 11'	TRACKER	LEFT	9582N	(*)	
B-KING	08' - 11'	GRAND TRACKER	RIGHT	9582N	(*)	
B-KING	08' - 11'	GRAND TRACKER	LEFT	9582N	(*)	
GS500	01' - 07'	HI-TECH IV	RIGHT	9582N	(*)	
GS500	01' - 07'	HI-TECH IV	LEFT	9582N	(*)	
GS500	01' - 07'	MP	RIGHT	9582N	(*)	
GS500	01' - 07'	MP	LEFT	9582N	(*)	
GS500	01' - 07'	TRACKER	RIGHT	9582N	(*)	
GS500	01' - 07'	TRACKER	LEFT	9582N	(*)	
GS500	01' - 07'	GRAND TRACKER	RIGHT	9582N	(*)	
GS500	01' - 07'	GRAND TRACKER	LEFT	9582N	(*)	
GSF650 BANDIT	05' - 14'	HI-TECH IV	RIGHT	9582N	(*)	
GSF650 BANDIT	05' - 14'	HI-TECH IV	LEFT	9582N	(*)	
GSF650 BANDIT	05' - 14'	MP	RIGHT	9582N	(*)	
GSF650 BANDIT	05' - 14'	MP	LEFT	9582N	(*)	
GSF650 BANDIT	05' - 14'	TRACKER	RIGHT	9582N	(*)	
GSF650 BANDIT	05' - 14'	TRACKER	LEFT	9582N	(*)	
GSF650 BANDIT	05' - 14'	GRAND TRACKER	RIGHT	9582N	(*)	
GSF650 BANDIT	05' - 14'	GRAND TRACKER	LEFT	9582N	(*)	
GSF1250 BANDIT	15' - 17'	HI-TECH IV	RIGHT	9582N	(*)	
GSF1250 BANDIT	15' - 17'	HI-TECH IV	LEFT	9582N	(*)	
GSF1250 BANDIT	15' - 17'	MP	RIGHT	9582N	(*)	
GSF1250 BANDIT	15' - 17'	MP	LEFT	9582N	(*)	
GSF1250 BANDIT	15' - 17'	TRACKER	RIGHT	9582N	(*)	
GSF1250 BANDIT	15' - 17'	TRACKER	LEFT	9582N	(*)	
GSF1250 BANDIT	15' - 17'	GRAND TRACKER	RIGHT	9582N	(*)	
GSF1250 BANDIT	15' - 17'	GRAND TRACKER	LEFT	9582N	(*)	
GSR600	06' - 11'	HI-TECH IV	RIGHT	9582N	(*)	
GSR600	06' - 11'	HI-TECH IV	LEFT	9582N	(*)	
GSR600	06' - 11'	MP	RIGHT	9582N	(*)	
GSR600	06' - 11'	MP	LEFT	9582N	(*)	
GSR600	06' - 11'	TRACKER	RIGHT	9582N	(*)	
GSR600	06' - 11'	TRACKER	LEFT	9582N	(*)	
GSR600	06' - 11'	GRAND TRACKER	RIGHT	9582N	(*)	
GSR600	06' - 11'	GRAND TRACKER	LEFT	9582N	(*)	

MODEL	YEAR	TYPE OF REAR MIRROR	SIDE	REF. ADAPTOR	N	P
GSR750	11' - 16'	HI-TECH IV	RIGHT	9582N	(*)	
GSR750	11' - 16'	HI-TECH IV	LEFT	9582N	(*)	
GSR750	11' - 16'	MP	RIGHT	9582N	(*)	
GSR750	11' - 16'	MP	LEFT	9582N	(*)	
GSR750	11' - 16'	TRACKER	RIGHT	9582N	(*)	
GSR750	11' - 16'	TRACKER	LEFT	9582N	(*)	
GSR750	11' - 16'	GRAND TRACKER	RIGHT	9582N	(*)	
GSR750	11' - 16'	GRAND TRACKER	LEFT	9582N	(*)	
GSX-S750	17' -18'	HI-TECH IV	RIGHT	9427N	(*)	
GSX-S750	17' -18'	HI-TECH IV	LEFT	9427N	(*)	
GSX-S750	17' -18'	MP	RIGHT	9427N	(*)	
GSX-S750	17' -18'	MP	LEFT	9427N	(*)	
GSX-S750	17' -18'	TRACKER	RIGHT	9427N	(*)	
GSX-S750	17' -18'	TRACKER	LEFT	9427N	(*)	
GSX-S750	17' -18'	GRAND TRACKER	RIGHT	9427N	(*)	
GSX-S750	17' -18'	GRAND TRACKER	LEFT	9427N	(*)	
GSX-S1000	15' - 18'	HI-TECH IV	RIGHT	9582N	(*)	
GSX-S1000	15' - 18'	HI-TECH IV	LEFT	9582N	(*)	
GSX-S1000	15' - 18'	MP	RIGHT	9582N	(*)	
GSX-S1000	15' - 18'	MP	LEFT	9582N	(*)	
GSX-S1000	15' - 18'	TRACKER	RIGHT	9582N	(*)	
GSX-S1000	15' - 18'	TRACKER	LEFT	9582N	(*)	
GSX-S1000	15' - 18'	GRAND TRACKER	RIGHT	9582N	(*)	
GSX-S1000	15' - 18'	GRAND TRACKER	LEFT	9582N	(*)	
GSX-R1000/R	17' - 18'	HI-TECH IV	RIGHT	9582N	(*)	
GSX-R1000/R	17' - 18'	HI-TECH IV	LEFT	9582N	(*)	
GSX-R1000/R	17' - 18'	MP	RIGHT	9582N	(*)	
GSX-R1000/R	17' - 18'	MP	LEFT	9582N	(*)	
GSX-R1000/R	17' - 18'	TRACKER	RIGHT	9582N	(*)	
GSX-R1000/R	17' - 18'	TRACKER	LEFT	9582N	(*)	
GSX-R1000/R	17' - 18'	GRAND TRACKER	RIGHT	9582N	(*)	
GSX-R1000/R	17' - 18'	GRAND TRACKER	LEFT	9582N	(*)	
GSX1400	01' - 06'	HI-TECH IV	RIGHT	9582N	(*)	
GSX1400	01' - 06'	HI-TECH IV	LEFT	9582N	(*)	
GSX1400	01' - 06'	MP	RIGHT	9582N	(*)	
GSX1400	01' - 06'	MP	LEFT	9582N	(*)	
GSX1400	01' - 06'	TRACKER	RIGHT	9582N	(*)	
GSX1400	01' - 06'	TRACKER	LEFT	9582N	(*)	
GSX1400	01' - 06'	GRAND TRACKER	RIGHT	9582N	(*)	
GSX1400	01' - 06'	GRAND TRACKER	LEFT	9582N	(*)	
INAZUMA	13' - 17'	HI-TECH IV	RIGHT	9582N	(*)	
INAZUMA	13' - 17'	HI-TECH IV	LEFT	9582N	(*)	
INAZUMA	13' - 17'	MP	RIGHT	9582N	(*)	
INAZUMA	13' - 17'	MP	LEFT	9582N	(*)	

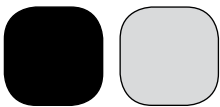

N
Black

P
Silver

(*) Check price with your distributor.

IMPORTANT: Indicate code color after part#. Example: 0973A.

ADAPTORS TO BAR END REARVIEW MIRRORS

HI-TECH PARTS | TYPE OF REAR MIRROR:

2019
MODELS:
www.puig.tv



GRAND TRACKER

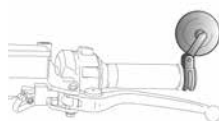

TRACKER



HI-TECH IV

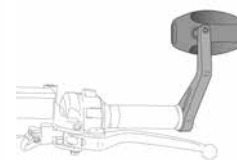

MP

MODEL	YEAR	TYPE OF REAR MIRROR	SIDE	REF. ADAPTOR	N	P
INAZUMA	13' - 17'	TRACKER	RIGHT	9582N	(*)	
INAZUMA	13' - 17'	TRACKER	LEFT	9582N	(*)	
INAZUMA	13' - 17'	GRAND TRACKER	RIGHT	9582N	(*)	
INAZUMA	13' - 17'	GRAND TRACKER	LEFT	9582N	(*)	
SFV650 GLADIUS	09' - 15'	HI-TECH IV	RIGHT	9582N	(*)	
SFV650 GLADIUS	09' - 15'	HI-TECH IV	LEFT	9582N	(*)	
SFV650 GLADIUS	09' - 15'	MP	RIGHT	9582N	(*)	
SFV650 GLADIUS	09' - 15'	MP	LEFT	9582N	(*)	
SFV650 GLADIUS	09' - 15'	TRACKER	RIGHT	9582N	(*)	
SFV650 GLADIUS	09' - 15'	TRACKER	LEFT	9582N	(*)	
SFV650 GLADIUS	09' - 15'	GRAND TRACKER	RIGHT	9582N	(*)	
SFV650 GLADIUS	09' - 15'	GRAND TRACKER	LEFT	9582N	(*)	
SV650	05' - 08'	HI-TECH IV	RIGHT	9582N	(*)	
SV650	05' - 08'	HI-TECH IV	LEFT	9582N	(*)	
SV650	05' - 08'	MP	RIGHT	9582N	(*)	
SV650	05' - 08'	MP	LEFT	9582N	(*)	
SV650	05' - 08'	TRACKER	RIGHT	9582N	(*)	
SV650	05' - 08'	TRACKER	LEFT	9582N	(*)	
SV650	05' - 08'	GRAND TRACKER	RIGHT	9582N	(*)	
SV650	05' - 08'	GRAND TRACKER	LEFT	9582N	(*)	
SV650	16' - 18'	HI-TECH IV	RIGHT	9582N	(*)	
SV650	16' - 18'	HI-TECH IV	LEFT	9582N	(*)	
SV650	16' - 18'	MP	RIGHT	9582N	(*)	
SV650	16' - 18'	MP	LEFT	9582N	(*)	
SV650	16' - 18'	TRACKER	RIGHT	9582N	(*)	
SV650	16' - 18'	TRACKER	LEFT	9582N	(*)	
SV650	16' - 18'	GRAND TRACKER	RIGHT	9582N	(*)	
SV650	16' - 18'	GRAND TRACKER	LEFT	9582N	(*)	
SV650X	18'	HI-TECH IV	RIGHT	9582N	(*)	
SV650X	18'	HI-TECH IV	LEFT	9582N	(*)	
SV650X	18'	MP	RIGHT	9582N	(*)	
SV650X	18'	MP	LEFT	9582N	(*)	
SV650X	18'	TRACKER	RIGHT	9582N	(*)	
SV650X	18'	TRACKER	LEFT	9582N	(*)	
SV650X	18'	GRAND TRACKER	RIGHT	9582N	(*)	
SV650X	18'	GRAND TRACKER	LEFT	9582N	(*)	
TRIUMPH						
THRUXTON 1200	16' - 18'	HI-TECH IV	RIGHT	UNIVERSAL - IT DOES NOT REQUIRE ADAPTOR		
THRUXTON 1200	16' - 18'	HI-TECH IV	LEFT	UNIVERSAL - IT DOES NOT REQUIRE ADAPTOR		
THRUXTON 1200	16' - 18'	MP	RIGHT	UNIVERSAL - IT DOES NOT REQUIRE ADAPTOR		

MODEL	YEAR	TYPE OF REAR MIRROR	SIDE	REF. ADAPTOR	N	P
THRUXTON 1200	16' - 18'	MP	LEFT	UNIVERSAL - IT DOES NOT REQUIRE ADAPTOR		
THRUXTON 1200	16' - 18'	TRACKER	RIGHT	UNIVERSAL - IT DOES NOT REQUIRE ADAPTOR		
THRUXTON 1200	16' - 18'	TRACKER	LEFT	UNIVERSAL - IT DOES NOT REQUIRE ADAPTOR		
THRUXTON 1200	16' - 18'	GRAND TRACKER	RIGHT	UNIVERSAL - IT DOES NOT REQUIRE ADAPTOR		
THRUXTON 1200	16' - 18'	GRAND TRACKER	LEFT	UNIVERSAL - IT DOES NOT REQUIRE ADAPTOR		
SPEED TRIPLE/R	16' - 18'	HI-TECH IV	RIGHT	UNIVERSAL - IT DOES NOT REQUIRE ADAPTOR		
SPEED TRIPLE/R	16' - 18'	HI-TECH IV	LEFT	UNIVERSAL - IT DOES NOT REQUIRE ADAPTOR		
SPEED TRIPLE/R	16' - 18'	MP	RIGHT	UNIVERSAL - IT DOES NOT REQUIRE ADAPTOR		
SPEED TRIPLE/R	16' - 18'	MP	LEFT	UNIVERSAL - IT DOES NOT REQUIRE ADAPTOR		
SPEED TRIPLE/R	16' - 18'	TRACKER	RIGHT	UNIVERSAL - IT DOES NOT REQUIRE ADAPTOR		
SPEED TRIPLE/R	16' - 18'	TRACKER	LEFT	UNIVERSAL - IT DOES NOT REQUIRE ADAPTOR		
SPEED TRIPLE/R	16' - 18'	GRAND TRACKER	RIGHT	UNIVERSAL - IT DOES NOT REQUIRE ADAPTOR		
SPEED TRIPLE/R	16' - 18'	GRAND TRACKER	LEFT	UNIVERSAL - IT DOES NOT REQUIRE ADAPTOR		
BONNEVILLE T100	16' - 18'	HI-TECH IV	RIGHT	9500N	(*)	
BONNEVILLE T100	16' - 18'	HI-TECH IV	LEFT	9500N	(*)	
BONNEVILLE T100	16' - 18'	MP	RIGHT	9500N	(*)	
BONNEVILLE T100	16' - 18'	MP	LEFT	9500N	(*)	
BONNEVILLE T100	16' - 18'	TRACKER	RIGHT	9500N	(*)	
BONNEVILLE T100	16' - 18'	TRACKER	LEFT	9500N	(*)	
BONNEVILLE T100	16' - 18'	GRAND TRACKER	RIGHT	9500N	(*)	
BONNEVILLE T100	16' - 18'	GRAND TRACKER	LEFT	9500N	(*)	
BONNEVILLE T120	16' - 18'	HI-TECH IV	RIGHT	9500N	(*)	
BONNEVILLE T120	16' - 18'	HI-TECH IV	LEFT	9500N	(*)	
BONNEVILLE T120	16' - 18'	MP	RIGHT	9500N	(*)	
BONNEVILLE T120	16' - 18'	MP	LEFT	9500N	(*)	
BONNEVILLE T120	16' - 18'	TRACKER	RIGHT	9500N	(*)	
BONNEVILLE T120	16' - 18'	TRACKER	LEFT	9500N	(*)	
BONNEVILLE T120	16' - 18'	GRAND TRACKER	RIGHT	9500N	(*)	
BONNEVILLE T120	16' - 18'	GRAND TRACKER	LEFT	9500N	(*)	
BONNEVILLE BOBBER	17' -18'	HI-TECH IV	RIGHT		CHECK WEB	
BONNEVILLE BOBBER	17' -18'	HI-TECH IV	LEFT		CHECK WEB	
BONNEVILLE BOBBER	17' -18'	MP	RIGHT		CHECK WEB	
BONNEVILLE BOBBER	17' -18'	MP	LEFT		CHECK WEB	
BONNEVILLE BOBBER	17' -18'	TRACKER	RIGHT		CHECK WEB	
BONNEVILLE BOBBER	17' -18'	TRACKER	LEFT		CHECK WEB	
BONNEVILLE BOBBER	17' -18'	GRAND TRACKER	RIGHT		CHECK WEB	
BONNEVILLE BOBBER	17' -18'	GRAND TRACKER	LEFT		CHECK WEB	
STREET CUP	17' -18'	HI-TECH IV	RIGHT		CHECK WEB	
STREET CUP	17' -18'	HI-TECH IV	LEFT		CHECK WEB	
STREET CUP	17' -18'	MP	RIGHT		CHECK WEB	
STREET CUP	17' -18'	MP	LEFT		CHECK WEB	
STREET CUP	17' -18'	TRACKER	RIGHT		CHECK WEB	
STREET CUP	17' -18'	TRACKER	LEFT		CHECK WEB	
STREET CUP	17' -18'	GRAND TRACKER	RIGHT		CHECK WEB	



N
Black

P
Silver

(*) Check price with your distributor.

IMPORTANT: Indicate code color after part#. Example: 0973A.

ADAPTORS TO BAR END REARVIEW MIRRORS

HI-TECH PARTS | TYPE OF REAR MIRROR:

2019
MODELS:
www.puig.tv



GRAND TRACKER

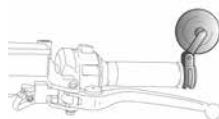

TRACKER



HI-TECH IV

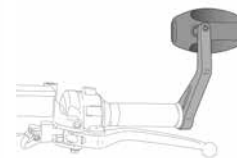

MP

MODEL	YEAR	TYPE OF REAR MIRROR	SIDE	REF. ADAPTOR	N	P
STREET CUP	17' -18'	GRAND TRACKER	LEFT		CHECK WEB	
STREET SCRAMBLER	17' -18'	HI-TECH IV	RIGHT	9500N	(*)	
STREET SCRAMBLER	17' -18'	HI-TECH IV	LEFT	9500N	(*)	
STREET SCRAMBLER	17' -18'	MP	RIGHT	9500N	(*)	
STREET SCRAMBLER	17' -18'	MP	LEFT	9500N	(*)	
STREET SCRAMBLER	17' -18'	TRACKER	RIGHT	9500N	(*)	
STREET SCRAMBLER	17' -18'	TRACKER	LEFT	9500N	(*)	
STREET SCRAMBLER	17' -18'	GRAND TRACKER	RIGHT	9500N	(*)	
STREET SCRAMBLER	17' -18'	GRAND TRACKER	LEFT	9500N	(*)	
STREET TRIPLE/R/S/RS	17' -18'	HI-TECH IV	RIGHT	9500N	(*)	
STREET TRIPLE/R/S/RS	17' -18'	HI-TECH IV	LEFT	9500N	(*)	
STREET TRIPLE/R/S/RS	17' -18'	MP	RIGHT	9500N	(*)	
STREET TRIPLE/R/S/RS	17' -18'	MP	LEFT	9500N	(*)	
STREET TRIPLE/R/S/RS	17' -18'	TRACKER	RIGHT	9500N	(*)	
STREET TRIPLE/R/S/RS	17' -18'	TRACKER	LEFT	9500N	(*)	
STREET TRIPLE/R/S/RS	17' -18'	GRAND TRACKER	RIGHT	9500N	(*)	
STREET TRIPLE/R/S/RS	17' -18'	GRAND TRACKER	LEFT	9500N	(*)	
STREET TWIN	16'-18'	HI-TECH IV	RIGHT	9500N	(*)	
STREET TWIN	16'-18'	HI-TECH IV	LEFT	9500N	(*)	
STREET TWIN	16'-18'	MP	RIGHT	9500N	(*)	
STREET TWIN	16'-18'	MP	LEFT	9500N	(*)	
STREET TWIN	16'-18'	TRACKER	RIGHT	9500N	(*)	
STREET TWIN	16'-18'	TRACKER	LEFT	9500N	(*)	
STREET TWIN	16'-18'	GRAND TRACKER	RIGHT	9500N	(*)	
STREET TWIN	16'-18'	GRAND TRACKER	LEFT	9500N	(*)	
YAMAHA						
FZ6	04' - 08'	HI-TECH IV	RIGHT	9583P		(*)
FZ6	04' - 08'	HI-TECH IV	LEFT	9583P		(*)
FZ6	04' - 08'	MP	RIGHT	9583P		(*)
FZ6	04' - 08'	MP	LEFT	9583P		(*)
FZ6	04' - 08'	TRACKER	RIGHT	9583P		(*)
FZ6	04' - 08'	TRACKER	LEFT	9583P		(*)
FZ6	04' - 08'	GRAND TRACKER	RIGHT	9583P		(*)
FZ6	04' - 08'	GRAND TRACKER	LEFT	9583P		(*)
MT-125	14' - 18'	HI-TECH IV	RIGHT	9583P		(*)
MT-125	14' - 18'	HI-TECH IV	LEFT	9583P		(*)
MT-125	14' - 18'	MP	RIGHT	9583P		(*)
MT-125	14' - 18'	MP	LEFT	9583P		(*)
MT-125	14' - 18'	TRACKER	RIGHT	9583P		(*)
MT-125	14' - 18'	TRACKER	LEFT	9583P		(*)

MODEL	YEAR	TYPE OF REAR MIRROR	SIDE	REF. ADAPTOR	N	P
MT-125	14' - 18'	GRAND TRACKER	RIGHT	9583P		(*)
MT-125	14' - 18'	GRAND TRACKER	LEFT	9583P		(*)
MT-03	16' - 18'	HI-TECH IV	RIGHT	9583P		(*)
MT-03	16' - 18'	HI-TECH IV	LEFT	9583P		(*)
MT-03	16' - 18'	MP	RIGHT	9583P		(*)
MT-03	16' - 18'	MP	LEFT	9583P		(*)
MT-03	16' - 18'	TRACKER	RIGHT	9583P		(*)
MT-03	16' - 18'	TRACKER	LEFT	9583P		(*)
MT-03	16' - 18'	GRAND TRACKER	RIGHT	9583P		(*)
MT-03	16' - 18'	GRAND TRACKER	LEFT	9583P		(*)
MT-07	14' - 18'	HI-TECH IV	RIGHT	9583P		(*)
MT-07	14' - 18'	HI-TECH IV	LEFT	9583P		(*)
MT-07	14' - 18'	MP	RIGHT	9583P		(*)
MT-07	14' - 18'	MP	LEFT	9583P		(*)
MT-07	14' - 18'	TRACKER	RIGHT	9583P		(*)
MT-07	14' - 18'	TRACKER	LEFT	9583P		(*)
MT-07	14' - 18'	GRAND TRACKER	RIGHT	9583P		(*)
MT-07	14' - 18'	GRAND TRACKER	LEFT	9583P		(*)
MT-09	13' - 18	HI-TECH IV	RIGHT	9583P		(*)
MT-09	13' - 18	HI-TECH IV	LEFT	9583P		(*)
MT-09	13' - 18	MP	RIGHT	9583P		(*)
MT-09	13' - 18	MP	LEFT	9583P		(*)
MT-09	13' - 18	TRACKER	RIGHT	9583P		(*)
MT-09	13' - 18	TRACKER	LEFT	9583P		(*)
MT-09	13' - 18	GRAND TRACKER	RIGHT	9583P		(*)
MT-09	13' - 18	GRAND TRACKER	LEFT	9583P		(*)
MT-09 SP	18'	HI-TECH IV	RIGHT	9583P		(*)
MT-09 SP	18'	HI-TECH IV	LEFT	9583P		(*)
MT-09 SP	18'	MP	RIGHT	9583P		(*)
MT-09 SP	18'	MP	LEFT	9583P		(*)
MT-09 SP	18'	TRACKER	RIGHT	9583P		(*)
MT-09 SP	18'	TRACKER	LEFT	9583P		(*)
MT-09 SP	18'	GRAND TRACKER	RIGHT	9583P		(*)
MT-09 SP	18'	GRAND TRACKER	LEFT	9583P		(*)
MT-10/SP		HI-TECH IV	RIGHT	9583P		(*)
MT-10/SP		HI-TECH IV	LEFT	9583P		(*)
MT-10/SP		MP	RIGHT	9583P		(*)
MT-10/SP		MP	LEFT	9583P		(*)
MT-10/SP		TRACKER	RIGHT	9583P		(*)
MT-10/SP		TRACKER	LEFT	9583P		(*)
MT-10/SP		GRAND TRACKER	RIGHT	9583P		(*)
MT-10/SP		GRAND TRACKER	LEFT	9583P		(*)
TDM 900	03' - 13'	HI-TECH IV	RIGHT	9583P		(*)
TDM 900	03' - 13'	HI-TECH IV	LEFT	9583P		(*)

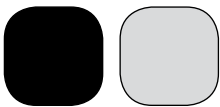

N
Black

P
Silver

(*) Check price with your distributor.

IMPORTANT: Indicate code color after part#. Example: 0973A.

ADAPTORS TO BAR END REARVIEW MIRRORS

HI-TECH PARTS | TYPE OF REAR MIRROR:

2019
MODELS:
www.puig.tv



GRAND TRACKER

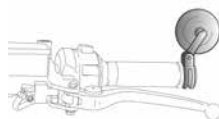

TRACKER



HI-TECH IV

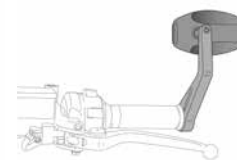

MP

MODEL	YEAR	TYPE OF REAR MIRROR	SIDE	REF. ADAPTOR	N	P
TDM 900	03' - 13'	MP	RIGHT	9583P		(*)
TDM 900	03' - 13'	MP	LEFT	9583P		(*)
TDM 900	03' - 13'	TRACKER	RIGHT	9583P		(*)
TDM 900	03' - 13'	TRACKER	LEFT	9583P		(*)
TDM 900	03' - 13'	GRAND TRACKER	RIGHT	9583P		(*)
TDM 900	03' - 13'	GRAND TRACKER	LEFT	9583P		(*)
T-MAX 530	12' - 16'	HI-TECH IV	RIGHT	9583P		(*)
T-MAX 530	12' - 16'	HI-TECH IV	LEFT	9583P		(*)
T-MAX 530	12' - 16'	MP	RIGHT	9583P		(*)
T-MAX 530	12' - 16'	MP	LEFT	9583P		(*)
T-MAX 530	12' - 16'	TRACKER	RIGHT	9583P		(*)
T-MAX 530	12' - 16'	TRACKER	LEFT	9583P		(*)
T-MAX 530	12' - 16'	GRAND TRACKER	RIGHT	9583P		(*)
T-MAX 530	12' - 16'	GRAND TRACKER	LEFT	9583P		(*)
T-MAX 530/DX/SX	17' - 18'	HI-TECH IV	RIGHT	9583P		(*)
T-MAX 530/DX/SX	17' - 18'	HI-TECH IV	LEFT	9583P		(*)
T-MAX 530/DX/SX	17' - 18'	MP	RIGHT	9583P		(*)
T-MAX 530/DX/SX	17' - 18'	MP	LEFT	9583P		(*)
T-MAX 530/DX/SX	17' - 18'	TRACKER	RIGHT	9583P		(*)
T-MAX 530/DX/SX	17' - 18'	TRACKER	LEFT	9583P		(*)
T-MAX 530/DX/SX	17' - 18'	GRAND TRACKER	RIGHT	9583P		(*)
T-MAX 530/DX/SX	17' - 18'	GRAND TRACKER	LEFT	9583P		(*)
XJ6	09' - 16'	HI-TECH IV	RIGHT	9583P		(*)
XJ6	09' - 16'	HI-TECH IV	LEFT	9583P		(*)
XJ6	09' - 16'	MP	RIGHT	9583P		(*)
XJ6	09' - 16'	MP	LEFT	9583P		(*)
XJ6	09' - 16'	TRACKER	RIGHT	9583P		(*)
XJ6	09' - 16'	TRACKER	LEFT	9583P		(*)
XJ6	09' - 16'	GRAND TRACKER	RIGHT	9583P		(*)
XJ6	09' - 16'	GRAND TRACKER	LEFT	9583P		(*)
XJR1300	99' - 13'	HI-TECH IV	RIGHT	9583P		(*)
XJR1300	99' - 13'	HI-TECH IV	LEFT	9583P		(*)
XJR1300	99' - 13'	MP	RIGHT	9583P		(*)
XJR1300	99' - 13'	MP	LEFT	9583P		(*)
XJR1300	99' - 13'	TRACKER	RIGHT	9583P		(*)
XJR1300	99' - 13'	TRACKER	LEFT	9583P		(*)
XJR1300	99' - 13'	GRAND TRACKER	RIGHT	9583P		(*)
XJR1300	99' - 13'	GRAND TRACKER	LEFT	9583P		(*)
X-MAX 125 (M16)	10' - 18'	HI-TECH IV	RIGHT	9583P		(*)
X-MAX 125 (M16)	10' - 18'	HI-TECH IV	LEFT	9583P		(*)

MODEL	YEAR	TYPE OF REAR MIRROR	SIDE	REF. ADAPTOR	N	P
X-MAX 125 (M16)	10' - 18'	MP	RIGHT	9583P		(*)
X-MAX 125 (M16)	10' - 18'	MP	LEFT	9583P		(*)
X-MAX 125 (M16)	10' - 18'	TRACKER	RIGHT	9583P		(*)
X-MAX 125 (M16)	10' - 16'	TRACKER	LEFT	9583P		(*)
X-MAX 125 (M16)	10' - 16'	GRAND TRACKER	RIGHT	9583P		(*)
X-MAX 125 (M16)	10' - 16'	GRAND TRACKER	LEFT	9583P		(*)
X-MAX 250 (M16)	10' - 16'	HI-TECH IV	RIGHT	9583P		(*)
X-MAX 250 (M16)	10' - 16'	HI-TECH IV	LEFT	9583P		(*)
X-MAX 250 (M16)	10' - 16'	MP	RIGHT	9583P		(*)
X-MAX 250 (M16)	10' - 16'	MP	LEFT	9583P		(*)
X-MAX 250 (M16)	10' - 16'	TRACKER	RIGHT	9583P		(*)
X-MAX 250 (M16)	10' - 16'	TRACKER	LEFT	9583P		(*)
X-MAX 250 (M16)	10' - 16'	GRAND TRACKER	RIGHT	9583P		(*)
X-MAX 250 (M16)	10' - 16'	GRAND TRACKER	LEFT	9583P		(*)
X-MAX 400	13' - 18'	HI-TECH IV	RIGHT	9583P		(*)
X-MAX 400	13' - 18'	HI-TECH IV	LEFT	9583P		(*)
X-MAX 400	13' - 18'	MP	RIGHT	9583P		(*)
X-MAX 400	13' - 18'	MP	LEFT	9583P		(*)
X-MAX 400	13' - 18'	TRACKER	RIGHT	9583P		(*)
X-MAX 400	13' - 18'	TRACKER	LEFT	9583P		(*)
X-MAX 400	13' - 18'	GRAND TRACKER	RIGHT	9583P		(*)
X-MAX 400	13' - 18'	GRAND TRACKER	LEFT	9583P		(*)
XSR700	16' - 18'	HI-TECH IV	RIGHT	9583P		(*)
XSR700	16' - 18'	HI-TECH IV	LEFT	9583P		(*)
XSR700	16' - 18'	MP	RIGHT	9583P		(*)
XSR700	16' - 18'	MP	LEFT	9583P		(*)
XSR700	16' - 18'	TRACKER	RIGHT	9583P		(*)
XSR700	16' - 18'	TRACKER	LEFT	9583P		(*)
XSR700	16' - 18'	GRAND TRACKER	RIGHT	9583P		(*)
XSR700	16' - 18'	GRAND TRACKER	LEFT	9583P		(*)
XSR900	16' - 18'	HI-TECH IV	RIGHT	9583P		(*)
XSR900	16' - 18'	HI-TECH IV	LEFT	9583P		(*)
XSR900	16' - 18'	MP	RIGHT	9583P		(*)
XSR900	16' - 18'	MP	LEFT	9583P		(*)
XSR900	16' - 18'	TRACKER	RIGHT	9583P		(*)
XSR900	16' - 18'	TRACKER	LEFT	9583P		(*)
XSR900	16' - 18'	GRAND TRACKER	RIGHT	9583P		(*)
XSR900	16' - 18'	GRAND TRACKER	LEFT	9583P		(*)

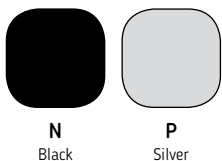

(*) Check price with your distributor.

IMPORTANT: Indicate code color after part#. Example: 0973A.

WINDSHIELDS FOR SCOOTERS

HI-TECH PARTS | TYPE OF WINDSHIELD:

2019
MODELS:
www.puig.tv

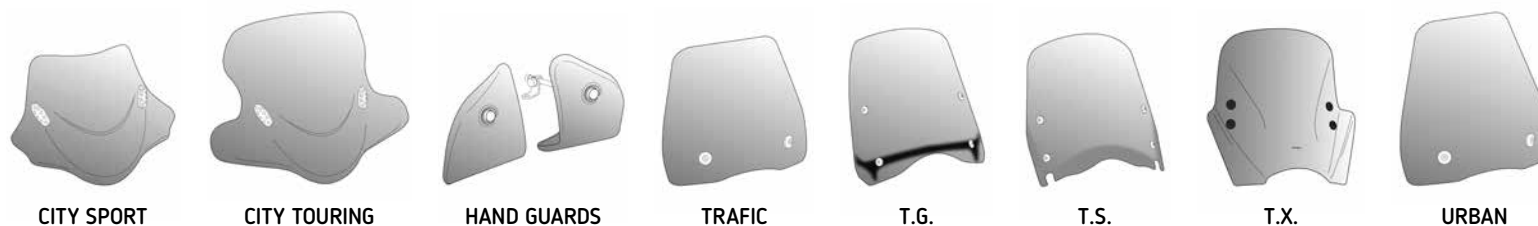

MODEL	YEAR	TYPE OF WINDSHIELD	REFERENCE	H	W
APRILIA					
LEONARDO 125	96' - 01'	CITY SPORT	0871H	(*)	
LEONARDO 125	96' - 01'	CITY TOURING	0872H	(*)	
LEONARDO 125	96' - 01'	HAND GUARDS	6855W		(*)
LEONARDO 150	98' - 01'	CITY SPORT	0871H	(*)	
LEONARDO 150	98' - 01'	CITY TOURING	0872H	(*)	
LEONARDO 150	98' - 01'	HAND GUARDS	6855W		(*)
LEONARDO 250	99' - 01'	CITY SPORT	0871H	(*)	
LEONARDO 250	99' - 01'	CITY TOURING	0872H	(*)	
LEONARDO 250	99' - 01'	HAND GUARDS	6855W		(*)
LEONARDO 250	99' - 01'	HAND GUARDS	6855W		(*)
SPORTCITY 125	04' - 08'	CITY TOURING	2399H	(*)	
SPORTCITY 125	04' - 08'	HAND GUARDS	6855W		(*)
SPORTCITY 200	06' - 08'	CITY TOURING	2399H	(*)	
SPORTCITY 200	06' - 08'	HAND GUARDS	6855W		(*)
SPORTCITY 200	06' - 08'	CITY TOURING	2399H	(*)	
SPORTCITY 200	06' - 08'	HAND GUARDS	6855W		(*)
SPORTCITY ONE 50	08' - 12'	CITY SPORT	5269H	(*)	
SPORTCITY ONE 50	08' - 12'	CITY TOURING	5270H	(*)	
SPORTCITY ONE 50	08' - 12'	TRAFIC	5595	(*)	(*)
SPORTCITY ONE 50	08' - 12'	URBAN	8447	(*)	(*)
SPORTCITY ONE 50	08' - 12'	T.G.	5594W		(*)
SPORTCITY ONE 50	08' - 12'	HAND GUARDS	6855W		(*)
SPORTCITY ONE 125	08' - 12'	CITY SPORT	5269H	(*)	
SPORTCITY ONE 125	08' - 12'	CITY TOURING	5270H	(*)	
SPORTCITY ONE 125	08' - 12'	TRAFIC	5595	(*)	(*)
SPORTCITY ONE 125	08' - 12'	URBAN	8447	(*)	(*)
SPORTCITY ONE 125	08' - 12'	T.G.	5594W		(*)
SPORTCITY ONE 125	08' - 12'	HAND GUARDS	6855W		(*)
SPORTCITY ONE 200	06' - 12'	CITY SPORT	5269H	(*)	
SPORTCITY ONE 200	06' - 12'	CITY TOURING	5270H	(*)	
SPORTCITY ONE 200	06' - 12'	TRAFIC	5595	(*)	(*)
SPORTCITY ONE 200	06' - 12'	URBAN	8447	(*)	(*)
SPORTCITY ONE 200	06' - 12'	T.G.	5594W		(*)
SPORTCITY ONE 200	06' - 12'	HAND GUARDS	6855W		(*)
SPORTCITY CUBE 125	08' - 13'	CITY SPORT	6024H	(*)	
SPORTCITY CUBE 125	08' - 13'	CITY TOURING	6025H	(*)	
SPORTCITY CUBE 125	08' - 13'	TRAFIC	6012	(*)	(*)
SPORTCITY CUBE 125	08' - 13'	URBAN	8448	(*)	(*)

MODEL	YEAR	TYPE OF WINDSHIELD	REFERENCE	H	W
SPORTCITY CUBE 125	08' - 13'	HAND GUARDS	6855W		(*)
SPORTCITY CUBE 300	08' - 13'	CITY SPORT	6024H	(*)	
SPORTCITY CUBE 300	08' - 13'	CITY TOURING	6025H	(*)	
SPORTCITY CUBE 300	08' - 13'	TRAFIC	6012	(*)	(*)
SPORTCITY CUBE 300	08' - 13'	URBAN	8448	(*)	(*)
SPORTCITY CUBE 300	08' - 13'	HAND GUARDS	6855W		(*)
SR50	94' - 00'	CITY SPORT	0871H	(*)	
SR50	94' - 00'	CITY TOURING	0872H	(*)	
SR50	94' - 00'	HAND GUARDS	6855W		(*)
SR50R	05' - 15'	CITY SPORT	8130H	(*)	
SR50R	05' - 15'	CITY TOURING	8137H	(*)	
SR50R	05' - 18'	TRAFIC	8151	(*)	(*)
SR50R	05' - 18'	URBAN	8181	(*)	(*)
SR50R	05' - 18'	HAND GUARDS	6855W		(*)
SR MOTARD 50	12' - 17'	CITY SPORT	6022H	(*)	
SR MOTARD 50	12' - 17'	CITY TOURING	6023H	(*)	
SR MOTARD 50	12' - 17'	TRAFIC	6011	(*)	(*)
SR MOTARD 50	12' - 17'	URBAN	8446	(*)	(*)
SR MOTARD 50	12' - 17'	HAND GUARDS	6855W		(*)
SR MOTARD 125	12' - 17'	CITY SPORT	6022H	(*)	
SR MOTARD 125	12' - 17'	CITY TOURING	6023H	(*)	
SR MOTARD 125	12' - 17'	TRAFIC	6011	(*)	(*)
SR MOTARD 125	12' - 17'	URBAN	8446	(*)	(*)
SR MOTARD 125	12' - 17'	HAND GUARDS	6855W		(*)
DAELIM					
BESBI 125	08' -17'	TRAFIC	6076	(*)	(*)
BESBI 125	08' -17'	URBAN	8449	(*)	(*)
BESBI 125	08' -17'	HAND GUARDS	6855W		(*)
NS 125		CITY SPORT	0350H	(*)	
NS 125		CITY TOURING	0173H	(*)	(*)
NS 125		HAND GUARDS	6855W		(*)
S1 125		CITY SPORT	4842H	(*)	
S1 125		CITY TOURING	4843H	(*)	
S1 125		HAND GUARDS	6855W		(*)
S FIVE 50	03' - 11'	CITY SPORT	1138H	(*)	
S FIVE 50	03' - 11'	CITY TOURING	1139H	(*)	
S FIVE 50	03' - 11'	HAND GUARDS	6855W		(*)
DERBI					
ATLANTIS		CITY SPORT	0635H	(*)	
ATLANTIS		CITY TOURING	0787H	(*)	
ATLANTIS		HAND GUARDS	6855W		(*)
ADVENTURE		T.G.	0148W		(*)
ADVENTURE		HAND GUARDS	6855W		(*)

(W) (H) COLORS: CITY SPORT

(W) (H) COLORS: CITY TOURING

(W) (H) COLORS: TRAFIC

(W) COLORS: T.G.

(W) COLORS: T.S.

(W) COLORS: HAND GUARDS

(W) (H) COLORS: URBAN

(*) Check price with your distributor.

IMPORTANT: Indicate code color after part#. Example: 0973A.

WINDSHIELDS FOR SCOOTERS

HI-TECH PARTS | TYPE OF WINDSHIELD:

2019
MODELS:
www.puig.tv

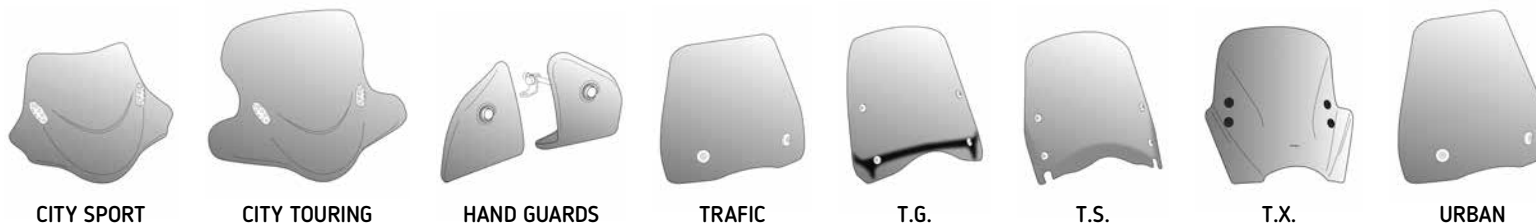

MODEL	YEAR	TYPE OF WINDSHIELD	REFERENCE	H	W
BULLET		CITY SPORT	0635H	(*)	
BULLET		CITY TOURING	0787H	(*)	
BULLET		HAND GUARDS	6855W		(*)
FURAX		T.G.	0148W		(*)
FURAX		HAND GUARDS	6855W		(*)
GP1		CITY SPORT	0449H	(*)	
GP1		CITY TOURING	0200H	(*)	
GP1		HAND GUARDS	6855W		(*)
PREDATOR		CITY SPORT	0449H	(*)	
PREDATOR		CITY TOURING	0200H	(*)	
PREDATOR		HAND GUARDS	6855W		(*)
RAMBLA		T.G.	4879W		(*)
RAMBLA		HAND GUARDS	6855W		(*)
URBAN		HAND GUARDS	6855W		(*)
VIVO		HAND GUARDS	6855W		(*)
GILERA					
RUNNER		CITY SPORT	1065H	(*)	
RUNNER		CITY TOURING	1066H	(*)	
RUNNER		HAND GUARDS	6855W		(*)
HONDA					
@	00' - 02'	CITY SPORT	0326H	(*)	
@	00' - 02'	CITY TOURING	0322H	(*)	
@	00' - 02'	HAND GUARDS	6855W		(*)
DYLAN	02' - 06'	CITY SPORT	1300H	(*)	
DYLAN	02' - 06'	CITY TOURING	1299H	(*)	
DYLAN	02' - 06'	T.G.	1298W		(*)
DYLAN	02' - 06'	HAND GUARDS	6855W		(*)
INNOVA	07' - 11'	T.G.	4647W		(*)
INNOVA	07' - 11'	HAND GUARDS	6855W		(*)
LEAD 100	03' - 07'	CITY SPORT	1529H	(*)	
LEAD 100	03' - 07'	CITY TOURING	1528H	(*)	
LEAD 100	03' - 07'	HAND GUARDS	6855W		(*)
NHX 110 LEAD	08' - 13'	TRAFIC	4872	(*)	(*)
NHX 110 LEAD	08' - 13'	URBAN	8450	(*)	(*)
NHX 110 LEAD	08' - 13'	T.G.	4685W		(*)
NHX 110 LEAD	08' - 13'	HAND GUARDS	6855W		(*)
PASSION 125	06' - 14'	TRAFIC	5673	(*)	(*)
PASSION 125	06' - 14'	URBAN	8451	(*)	(*)
PASSION 125	06' - 14'	T.S.	4323W		(*)

MODEL	YEAR	TYPE OF WINDSHIELD	REFERENCE	H	W
PASSION 125	06' - 14'	HAND GUARDS	6855W		(*)
SCOOPY 80		HAND GUARDS	6855W		(*)
SCOOPY SH50		T.G.	0092W		(*)
SCOOPY SH50		HAND GUARDS	6855W		(*)
SCOOPY SH100		T.G.	0092W		(*)
SCOOPY SH100		HAND GUARDS	6855W		(*)
SCOOPY SH125	02' - 05'	T.S.	1012W		(*)
SCOOPY SH125	02' - 05'	HAND GUARDS	6855W		(*)
SCOOPY SH125i	06' - 08'	CITY TOURING	4621H	(*)	
SCOOPY SH125i	06' - 08'	TRAFIC	4045	(*)	(*)
SCOOPY SH125i	06' - 08'	URBAN	8452	(*)	(*)
SCOOPY SH125i	06' - 08'	T.S.	4028W		(*)
SCOOPY SH125i	06' - 08'	HAND GUARDS	6855W		(*)
SCOOPY SH125i	09' - 12'	T.S.	5183W		(*)
SCOOPY SH125i	09' - 12'	HAND GUARDS	6855W		(*)
SCOOPY SH125i	13' - 16'	CITY TOURING	6436H	(*)	
SCOOPY SH125i	13' - 16'	TRAFIC	6411	(*)	(*)
SCOOPY SH125i	13' - 16'	URBAN	8453	(*)	(*)
SCOOPY SH125i	13' - 16'	T.S.	6403W		(*)
SCOOPY SH125i	13' - 16'	HAND GUARDS	6855W		(*)
SCOOPY SH125i	17' - 18'	TRAFIC	9384	(*)	(*)
SCOOPY SH125i	17' - 18'	URBAN	9385	(*)	(*)
SCOOPY SH125i	17' - 18'	T.S.	9383W		(*)
SCOOPY SH125i	18'	T.X.	9733W		(*)
SCOOPY SH125i	17' - 18'	HAND GUARDS	6855W		(*)
SCOOPY SH150	02' - 05'	T.S.	1012W		(*)
SCOOPY SH150	02' - 05'	HAND GUARDS	6855W		(*)
SCOOPY SH150i	06' - 08'	CITY TOURING	4621H	(*)	
SCOOPY SH150i	06' - 08'	TRAFIC	4045	(*)	(*)
SCOOPY SH150i	06' - 08'	URBAN	8452	(*)	(*)
SCOOPY SH150i	06' - 08'	T.S.	4028W		(*)
SCOOPY SH150i	06' - 08'	HAND GUARDS	6855W		(*)
SCOOPY SH150i	09' - 12'	T.S.	5183W		(*)
SCOOPY SH150i	09' - 12'	HAND GUARDS	6855W		(*)
SCOOPY SH150i	13' - 16'	CITY TOURING	6436H	(*)	
SCOOPY SH150i	13' - 16'	TRAFIC	6411	(*)	(*)
SCOOPY SH150i	13' - 16'	URBAN	8453	(*)	(*)
SCOOPY SH150i	13' - 16'	T.S.	6403W		(*)
SCOOPY SH150i	13' - 16'	HAND GUARDS	6855W		(*)
SCOOPY SH150i	17' - 18'	TRAFIC	9384	(*)	(*)
SCOOPY SH150i	17' - 18'	URBAN	9385	(*)	(*)
SCOOPY SH150i	17' - 18'	T.S.	9383W		(*)
SCOOPY SH150i	18'	T.X.	9733W		(*)

(W) (H) COLORS: CITY SPORT

(W) COLORS: T.S.

(W) (H) COLORS: CITY TOURING

(W) COLORS: HAND GUARDS

(W) (H) COLORS: TRAFIC

(W) (H) COLORS: URBAN

(W) COLORS: T.G.

(*) Check price with your distributor.

IMPORTANT: Indicate code color after part#. Example: 0973A.

WINDSHIELDS FOR SCOOTERS

HI-TECH PARTS | TYPE OF WINDSHIELD:

2019
MODELS:
www.puig.tv



CITY SPORT



CITY TOURING



HAND GUARDS



TRAFIC



T.G.



T.S.



T.X.



URBAN

MODEL	YEAR	TYPE OF WINDSHIELD	REFERENCE	H	W
SCOOPY SH300i	07' - 10'	CITY TOURING	4874H	(*)	
SCOOPY SH300i	07' - 10'	TRAFIC	4045	(*)	(*)
SCOOPY SH300i	07' - 10'	URBAN	8452	(*)	(*)
SCOOPY SH300i	07' - 10'	T.S.	4400W		(*)
SCOOPY SH300i	07' - 10'	HAND GUARDS	6855W		(*)
SCOOPY SH300i	11' - 14'	CITY TOURING	4874H	(*)	
SCOOPY SH300i	11' - 14'	TRAFIC	5848	(*)	(*)
SCOOPY SH300i	11' - 14'	URBAN	8454	(*)	(*)
SCOOPY SH300i	11' - 14'	T.G.	5847W		(*)
SCOOPY SH300i	11' - 14'	HAND GUARDS	6855W		(*)
SCOOPY SH300i	15' - 18'	TRAFIC	8134	(*)	(*)
SCOOPY SH300i	15' - 18'	URBAN	8135	(*)	(*)
SCOOPY SH300i	15' - 18'	T.S.	8136W		(*)
SCOOPY SH300i	15' - 18'	HAND GUARDS	6855W		(*)
SH MODE 125	13' - 18'	TRAFIC	6999	(*)	(*)
SH MODE 125	13' - 18'	URBAN	8455	(*)	(*)
SH MODE 125	13' - 18'	T.S.	6998W		(*)
SH MODE 125	13' - 18'	HAND GUARDS	6855W		(*)
SPACY CHA 125	99'	CITY TOURING	0089H	(*)	
VISION 50	11' - 16'	TRAFIC	5894	(*)	(*)
VISION 50	11' - 16'	URBAN	8456	(*)	(*)
VISION 50	11' - 16'	T.S.	5893W		(*)
VISION 50	11' - 16'	HAND GUARDS	6855W		(*)
VISION 110	11' - 16'	TRAFIC	5894	(*)	(*)
VISION 110	11' - 16'	URBAN	8456	(*)	(*)
VISION 110	11' - 16'	T.S.	5893W		(*)
VISION 110	11' - 16'	HAND GUARDS	6855W		(*)
VISION 110	17' - 18'	TRAFIC	9340	(*)	(*)
VISION 110	17' - 18'	URBAN	9341	(*)	(*)
VISION 110	17' - 18'	T.S.	9342W		(*)
VISION 110	17' - 18'	HAND GUARDS	6855W		(*)
WAVE	12' - 13'	TRAFIC	6789	(*)	(*)
WAVE	12' - 13'	URBAN	8457	(*)	(*)
ITALJET					
BAZOOKA		T.G.	0749W		(*)
BAZOOKA		HAND GUARDS	6855W		(*)
KEEWAY					
FACT 50 EVO		URBAN	8104	(*)	(*)
FACT 50 EVO		TRAFIC	8103	(*)	(*)

MODEL	YEAR	TYPE OF WINDSHIELD	REFERENCE	H	W
FACT 50 EVO		HAND GUARDS	6855W		(*)
FACT 50/125		CITY SPORT	6518H	(*)	
FACT 50/125		CITY TOURING	6527H	(*)	
FACT 50/125		HAND GUARDS	6855W		(*)
LOGIK 125	18'	TRAFIC	1432	(*)	(*)
LOGIK 125	18'	URBAN	1438	(*)	(*)
LOGIK 125	18'	T.X.	1399W		(*)
OUTLOOK		CITY SPORT	6266H	(*)	
OUTLOOK		CITY TOURING	6267H	(*)	
OUTLOOK		HAND GUARDS	6855W		(*)
ZAHARA 50/125		T.S.	8966W		(*)
ZAHARA 50/125		HAND GUARDS	6855W		(*)
KSR MOTO					
SOHO 125		T.S.	9391W		(*)
SOHO 125		HAND GUARDS	6855W		(*)
KYMCO					
AGILITY 50	05' - 16'	CITY SPORT	5024H	(*)	
AGILITY 50	05' - 16'	CITY TOURING	5025H	(*)	
AGILITY 50	05' - 16'	TRAFIC	5671	(*)	(*)
AGILITY 50	05' - 16'	URBAN	8458	(*)	(*)
AGILITY 50	05' - 16'	T.S.	4324W		(*)
AGILITY 50	05' - 16'	HAND GUARDS	6855W		(*)
AGILITY CITY 50	11' - 18'	CITY SPORT	6026H	(*)	
AGILITY CITY 50	11' - 18'	CITY TOURING	6027H	(*)	
AGILITY CITY 50	11' - 18'	TRAFIC	6013	(*)	(*)
AGILITY CITY 50	11' - 18'	URBAN	8460	(*)	(*)
AGILITY CITY 50	11' - 18'	T.S.	6851W		(*)
AGILITY CITY 50	11' - 18'	HAND GUARDS	6855W		(*)
AGILITY CITY +50	15' - 17'	CITY TOURING	9439H	(*)	
AGILITY CITY+ 50	15' - 17'	T.S.	9241W		(*)
AGILITY CITY+ 50	15' - 17'	HAND GUARDS	6855W		(*)
AGILITY 125	05' - 16'	CITY SPORT	5024H	(*)	
AGILITY 125	05' - 16'	CITY TOURING	5025H	(*)	
AGILITY 125	05' - 16'	TRAFIC	5671	(*)	(*)
AGILITY 125	05' - 16'	URBAN	8458	(*)	(*)
AGILITY 125	05' - 16'	T.S.	4324W		(*)
AGILITY 125	05' - 16'	HAND GUARDS	6855W		(*)
AGILITY CITY 125	11' - 18'	CITY SPORT	6026H	(*)	
AGILITY CITY 125	11' - 18'	CITY TOURING	6027H	(*)	
AGILITY CITY 125	11' - 18'	TRAFIC	6013	(*)	(*)
AGILITY CITY 125	11' - 18'	URBAN	8460	(*)	(*)
AGILITY CITY 125	11' - 18'	T.S.	6851W		(*)
AGILITY CITY 125	11' - 18'	HAND GUARDS	6855W		(*)

(W) (H) COLORS: CITY SPORT

(W) (H) COLORS: CITY TOURING

(W) (H) COLORS: TRAFIC

(W) COLORS: T.G.

(W) COLORS: T.S.

(W) COLORS: HAND GUARDS

(W) (H) COLORS: URBAN

(*) Check price with your distributor.

IMPORTANT: Indicate code color after part#. Example: 0973A.

WINDSHIELDS FOR SCOOTERS

HI-TECH PARTS | TYPE OF WINDSHIELD:

2019
MODELS:
www.puig.tv



CITY SPORT



CITY TOURING



HAND GUARDS



TRAFIC



T.G.



T.S.

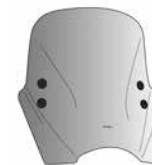

T.X.



URBAN

MODEL	YEAR	TYPE OF WINDSHIELD	REFERENCE	H	W
AGILITY CITY +125	15' - 17'	CITY TOURING	9439H	(*)	
AGILITY CITY +125	15' - 17'	T.S.	9241W		(*)
AGILITY CITY +125	15' - 17'	HAND GUARDS	6855W		(*)
AGILITY CITY 150	11' - 16'	CITY SPORT	6026H	(*)	
AGILITY CITY 150	11' - 16'	CITY TOURING	6027H	(*)	
AGILITY CITY 150	11' - 16'	TRAFIC	6013	(*)	(*)
AGILITY CITY 150	11' - 16'	URBAN	8460	(*)	(*)
AGILITY CITY 150	11' - 16'	T.S.	6851W		(*)
AGILITY CITY 150	11' - 16'	HAND GUARDS	6855W		(*)
AGILITY CITY 200i	11' - 16'	CITY SPORT	6026H	(*)	
AGILITY CITY 200i	11' - 16'	CITY TOURING	6027H	(*)	
AGILITY CITY 200i	11' - 16'	TRAFIC	6013	(*)	(*)
AGILITY CITY 200i	11' - 16'	URBAN	8460	(*)	(*)
AGILITY CITY 200i	11' - 16'	T.S.	6851W		(*)
AGILITY CITY 200i	11' - 16'	HAND GUARDS	6855W		(*)
BET&WIN		CITY SPORT	0991H	(*)	
BET&WIN		CITY TOURING	0992H	(*)	
BET&WIN		HAND GUARDS	6855W		(*)
AGILITY RS 50		CITY TOURING	6027H	(*)	
AGILITY RS 50		HAND GUARDS	6855W		(*)
AGILITY RS 125		CITY TOURING	6027H	(*)	
AGILITY RS 125		HAND GUARDS	6855W		(*)
DJS50	11' - 18'	CITY TOURING	6027H	(*)	
DJS50	11' - 18'	HAND GUARDS	6855W		(*)
DJS125	11' - 18'	CITY TOURING	6027H	(*)	
DJS125	11' - 18'	HAND GUARDS	6855W		(*)
G5	09' - 10'	CITY TOURING	5520H	(*)	
G5	09' - 10'	T.G.	5259W		(*)
G5	09' - 10'	HAND GUARDS	6855W		(*)
FILLY 125	18'	TRAFIC	9501	(*)	(*)
FILLY 125	18'	URBAN	9502	(*)	(*)
FILLY 125	18'	T.S.	9769		(*)
FILLY 125	18'	HAND GUARDS	6855W		(*)
LIKE 50	09' - 16'	TRAFIC	5670	(*)	(*)
LIKE 50	09' - 16'	URBAN	8461	(*)	(*)
LIKE 50	09' - 16'	T.S.	6809W		(*)
LIKE 50	09' - 16'	HAND GUARDS	6855W		(*)
LIKE 50	17' - 18'	TRAFIC	9838	(*)	(*)
LIKE 50	17' - 18'	URBAN	9839	(*)	(*)

MODEL	YEAR	TYPE OF WINDSHIELD	REFERENCE	H	W
LIKE 50	17' - 18'	T.S.	9840W		(*)
LIKE 50	17' - 18'	HAND GUARDS	6855W		(*)
LIKE 125	09' - 16'	TRAFIC	5670	(*)	(*)
LIKE 125	09' - 16'	URBAN	8461	(*)	(*)
LIKE 125	09' - 16'	T.S.	6809W		(*)
LIKE 125	09' - 16'	HAND GUARDS	6855W		(*)
LIKE 125	17' - 18'	TRAFIC	9838	(*)	(*)
LIKE 125	17' - 18'	URBAN	9839	(*)	(*)
LIKE 125	17' - 18'	T.S.	9840W		(*)
LIKE 125	17' - 18'	HAND GUARDS	6855W		(*)
LIKE 200i	09' - 16'	TRAFIC	5670	(*)	(*)
LIKE 200i	09' - 16'	URBAN	8461	(*)	(*)
LIKE 200i	09' - 16'	T.S.	6809W		(*)
LIKE 200i	09' - 16'	HAND GUARDS	6855W		(*)
MILER 125	17' - 18'	TRAFIC	9501	(*)	(*)
MILER 125	17' - 18'	URBAN	9502	(*)	(*)
MILER 125	17' - 18'	T.S.	9503W		(*)
MILER 125	17' - 18'	HAND GUARDS	6855W		(*)
PEOPLE		HAND GUARDS	6855W		(*)
PEOPLE GT125i	10' - 18'	TRAFIC	6870	(*)	(*)
PEOPLE GT125i	10' - 18'	URBAN	8462	(*)	(*)
PEOPLE GT125i	10' - 18'	T.S.	6848W		(*)
PEOPLE GT125i	10' - 18'	HAND GUARDS	6855W		(*)
PEOPLE GT200i	10' - 16'	TRAFIC	6870	(*)	(*)
PEOPLE GT200i	10' - 16'	URBAN	8462	(*)	(*)
PEOPLE GT200i	10' - 18'	T.S.	6848W		(*)
PEOPLE GT200i	10' - 18'	HAND GUARDS	6855W		(*)
PEOPLE GT300i	10' - 18'	TRAFIC	6870	(*)	(*)
PEOPLE GT300i	10' - 18'	URBAN	8462	(*)	(*)
PEOPLE GT300i	10' - 18'	T.S.	6848W		(*)
PEOPLE GT300i	10' - 18'	HAND GUARDS	6855W		(*)
PEOPLE S 50	05' - 06'	OEM (#)	4402W		(*)
PEOPLE S 50	05' - 06'	HAND GUARDS	6855W		(*)
PEOPLE S 50	07 - 18'	OEM (#)	4402W		(*)
PEOPLE S 50	07 - 18'	HAND GUARDS	6855W		(*)
PEOPLE S 125	05'	OEM (#)	4402W		(*)
PEOPLE S 125	05'	HAND GUARDS	6855W		(*)
PEOPLE S 125	06' - 16'	OEM (#)	4402W		(*)
PEOPLE S 125	06' - 16'	HAND GUARDS	6855W		(*)
PEOPLE S 125	17' - 18'	HAND GUARDS	6855W		(*)
PEOPLE S 150	06' - 14'	OEM (#)	4402W		(*)
PEOPLE S 150	06' - 14'	HAND GUARDS	6855W		(*)
PEOPLE S 200i	07' - 16'	OEM (#)	4402W		(*)

(W) (H) COLORS: CITY SPORT

(W) (H) COLORS: CITY TOURING

(W) (H) COLORS: TRAFIC

(W) COLORS: T.G.

(W) COLORS: T.S.

(W) COLORS: HAND GUARDS

(W) (H) COLORS: URBAN

(*) Check price with your distributor.

IMPORTANT: Indicate code color after part#. Example: 0973A.

WINDSHIELDS FOR SCOOTERS

HI-TECH PARTS | TYPE OF WINDSHIELD:

2019
MODELS:
www.puig.tv

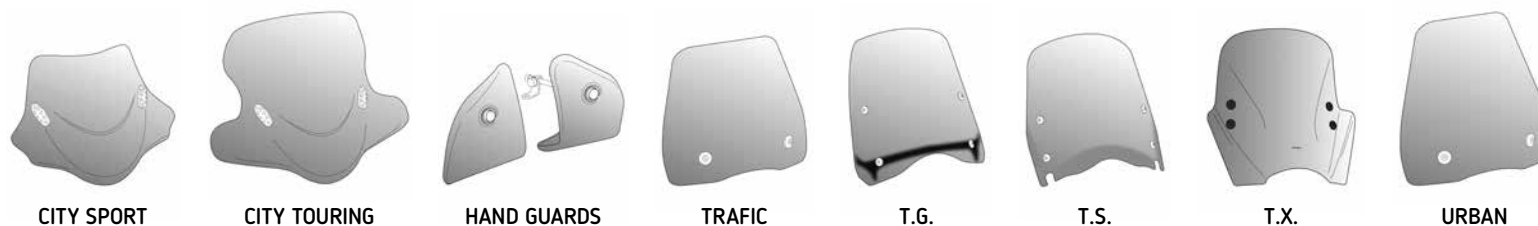

MODEL	YEAR	TYPE OF WINDSHIELD	REFERENCE	H	W
PEOPLE S 200i	07' - 16'	HAND GUARDS	6855W		(*)
PEOPLE S 300i	09' - 10'	OEM (#)	4402W		(*)
PEOPLE S 300i	09' - 10'	HAND GUARDS	6855W		(*)
SUPER8 50/125		CITY SPORT	6807H	(*)	
SUPER8 50/125		CITY TOURING	6808H	(*)	
SUPER8 50/125		HAND GUARDS	6855W		(*)
SUPER9 50/125		CITY SPORT	1500H	(*)	
SUPER9 50/125		CITY TOURING	1501H	(*)	
SUPER9 50/125		HAND GUARDS	6855W		(*)
TOP BOY 50/100		CITY SPORT	1987H	(*)	
TOP BOY 50/100		CITY TOURING	1986H	(*)	
TOP BOY 50/100		HAND GUARDS	6855W		(*)
VITALITY 50	04' - 18'	CITY SPORT	1988H	(*)	
VITALITY 50	04' - 18'	CITY TOURING	1989H	(*)	
YUP		HAND GUARDS	6855W		(*)
LINHAI					
DRIVE-IN		HAND GUARDS	6855W		(*)
MALAGUTTI					
F-10		HAND GUARDS	6855W		(*)
PEUGEOT					
BELVILLE 125/200		TRAFIC	9967	(*)	(*)
BELVILLE 125/200		URBAN	9968	(*)	(*)
BELVILLE 125/200		T.S.	9969W		(*)
BELVILLE 125/200		HAND GUARDS	6855W		(*)
DJANGO 50/125/150		TRAFIC	9216	(*)	(*)
DJANGO 50/125/150		URBAN	9217	(*)	(*)
DJANGO 50/125/150		T.S.	9218W		(*)
DJANGO 50/125/150		HAND GUARDS	6855W		(*)
JET FORCE 50		CITY SPORT	1680H	(*)	
JET FORCE 50		CITY TOURING	1684H	(*)	
JET FORCE 50		HAND GUARDS	6855W		(*)
KISBEE/RS		TRAFIC	6886	(*)	(*)
KISBEE/RS		URBAN	8464	(*)	(*)
KISBEE 100		TRAFIC	6886	(*)	(*)
KISBEE 100		URBAN	8464	(*)	(*)
LOOXOR		CITY SPORT	1004H	(*)	
LOOXOR		CITY TOURING	1003H	(*)	
LXR125/200i		HAND GUARDS	6855W		(*)
SC 75		HAND GUARDS	6855W		(*)

MODEL	YEAR	TYPE OF WINDSHIELD	REFERENCE	H	W
SPEEDAKE		HAND GUARDS	6855W		(*)
SPEEDFIGHT		CITY SPORT	1050H	(*)	
SPEEDFIGHT		CITY TOURING	1052H	(*)	
SPEEDFIGHT 3		CITY SPORT	7672H	(*)	
SPEEDFIGHT 3		CITY TOURING	7673H	(*)	
SPEEDFIGHT 4		CITY SPORT	9027H	(*)	
SPEEDFIGHT 4		CITY TOURING	9028H	(*)	
SPEEDFIGHT 125		CITY SPORT	9027H	(*)	
SPEEDFIGHT 125		CITY TOURING	9028H	(*)	
SUM-UP 125		CITY SPORT	5174H	(*)	
SUM-UP 125		CITY TOURING	5175H	(*)	
SUM-UP 125		HAND GUARDS	6855W		(*)
TKR 50		CITY SPORT	6521H	(*)	
TKR 50		CITY TOURING	6530H	(*)	
TKR 50		HAND GUARDS	6855W		(*)
TWEET 50/RS		TRAFIC	5874	(*)	(*)
TWEET 50/RS		URBAN	8465	(*)	(*)
TWEET 50/RS		T.G.	5675W		(*)
TWEET 50/RS		HAND GUARDS	6855W		(*)
TWEET 125/RS		TRAFIC	5874	(*)	(*)
TWEET 125/RS		URBAN	8465	(*)	(*)
TWEET 125/RS		T.G.	5675W		(*)
TWEET 125/RS		HAND GUARDS	6855W		(*)
TWEET 125 PRO		TRAFIC	5874	(*)	(*)
TWEET 125 PRO		URBAN	8465	(*)	(*)
TWEET 125 PRO		T.G.	5675W		(*)
TWEET 125 PRO		HAND GUARDS	6855W		(*)
VIVACITY 50	04' - 08'	CITY SPORT	4677H	(*)	
VIVACITY 50	04' - 08'	CITY TOURING	4679H	(*)	
VIVACITY 50	04' - 08'	T.G.	0281W		(*)
VIVACITY 50	04' - 08'	HAND GUARDS	6855W		(*)
VIVACITY 50	09' - 16'	TRAFIC	5628	(*)	(*)
VIVACITY 50	09' - 16'	URBAN	8466	(*)	(*)
VIVACITY 50	09' - 16'	T.G.	4676W		(*)
VIVACITY 50	09' - 16'	HAND GUARDS	6855W		(*)
VIVACITY 125/RS	12' - 16'	TRAFIC	5628	(*)	(*)
VIVACITY 125/RS	12' - 16'	URBAN	8466	(*)	(*)
VIVACITY 125/RS	12' - 16'	T.G.	4676W		(*)
VIVACITY 125/RS	12' - 16'	HAND GUARDS	6855W		(*)
V-CLIC		TRAFIC	5877	(*)	(*)
V-CLIC		URBAN	8467	(*)	(*)
V-CLIC		T.S.	5268W		(*)
V-CLIC		HAND GUARDS	6855W		(*)

(W) (H) COLORS: CITY SPORT

(W) (H) COLORS: CITY TOURING

(W) (H) COLORS: TRAFIC

(W) COLORS: T.G.

(W) COLORS: T.S.

(W) COLORS: HAND GUARDS

(W) (H) COLORS: URBAN

(*) Check price with your distributor.

IMPORTANT: Indicate code color after part#. Example: 0973A.

WINDSHIELDS FOR SCOOTERS

HI-TECH PARTS | TYPE OF WINDSHIELD:

2019
MODELS:
www.puig.tv

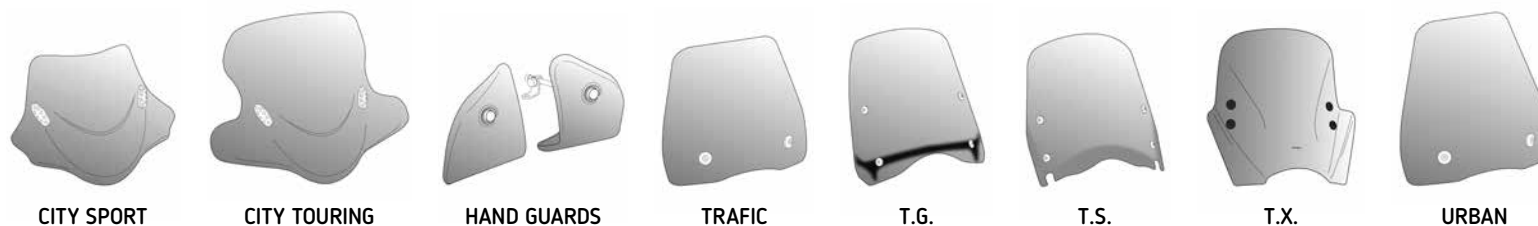

MODEL	YEAR	TYPE OF WINDSHIELD	REFERENCE	H	W
PGO					
BIG MAX 50		CITY SPORT	0107H	(*)	
BIG MAX 50		CITY TOURING	0229H	(*)	
BIG MAX 50		HAND GUARDS	6855W		(*)
PMX 50		CITY SPORT	0778H	(*)	
PMX 50		CITY TOURING	0958H	(*)	
PMX 50		HAND GUARDS	6855W		(*)
PIAGGIO					
BEVERLY 125	11' - 14'	T.S.	6265W		(*)
BEVERLY 125	11' - 14'	HAND GUARDS	6855W		(*)
BEVERLY 300	11' - 15'	T.S.	6265W		(*)
BEVERLY 300	11' - 15'	HAND GUARDS	6855W		(*)
BEVERLY S 125	14' - 16'	T.S.	6265W		(*)
BEVERLY S 125	14' - 16'	HAND GUARDS	6855W		(*)
BEVERLY 300	14' - 18'	T.S.	6265W		(*)
BEVERLY 300	14' - 18'	HAND GUARDS	6855W		(*)
BEVERLY S 300	14' - 18'	T.S.	6265W		(*)
BEVERLY S 300	14' - 18'	HAND GUARDS	6855W		(*)
LIBERTY 50	04' - 10'	TRAFIC	5672	(*)	(*)
LIBERTY 50	04' - 10'	URBAN	8468	(*)	(*)
LIBERTY 50	04' - 10'	T.G.	1994W		(*)
LIBERTY 50	04' - 10'	HAND GUARDS	6855W		(*)
LIBERTY 50	11' - 16'	TRAFIC	5858	(*)	(*)
LIBERTY 50	11' - 16'	URBAN	8469	(*)	(*)
LIBERTY 50	11' - 16'	T.S.	5850W		(*)
LIBERTY 50	11' - 16'	HAND GUARDS	6855W		(*)
LIBERTY 50/S	17' - 18'	TRAFIC	5858	(*)	(*)
LIBERTY 50/S	17' - 18'	URBAN	8469	(*)	(*)
LIBERTY 50/S	17' - 18'	T.S.	5850W		(*)
LIBERTY 50/S	17' - 18'	HAND GUARDS	6855W		(*)
LIBERTY 125	04' - 10'	TRAFIC	5672	(*)	(*)
LIBERTY 125	04' - 10'	URBAN	8468	(*)	(*)
LIBERTY 125	04' - 10'	T.G.	1994W		(*)
LIBERTY 125	04' - 10'	HAND GUARDS	6855W		(*)
LIBERTY 125	11' - 16'	TRAFIC	5858	(*)	(*)
LIBERTY 125	11' - 16'	URBAN	8469	(*)	(*)
LIBERTY 125	11' - 16'	T.S.	5850W		(*)
LIBERTY 125	11' - 16'	HAND GUARDS	6855W		(*)
LIBERTY 125/S	17' - 18'	TRAFIC	5858	(*)	(*)

MODEL	YEAR	TYPE OF WINDSHIELD	REFERENCE	H	W
LIBERTY 125/S	17' - 18'	URBAN	8469	(*)	(*)
LIBERTY 125/S	17' - 18'	T.S.	5850W		(*)
LIBERTY 125/S	17' - 18'	HAND GUARDS	6855W		(*)
LIBERTY 150	04' - 10'	TRAFIC	5672	(*)	(*)
LIBERTY 150	04' - 10'	URBAN	8468	(*)	(*)
LIBERTY 150	04' - 10'	T.G.	1994W		(*)
LIBERTY 150	04' - 10'	HAND GUARDS	6855W		(*)
LIBERTY 150	11' - 16'	TRAFIC	5858	(*)	(*)
LIBERTY 150	11' - 16'	URBAN	8469	(*)	(*)
LIBERTY 150	11' - 16'	T.S.	5850W		(*)
LIBERTY 150	11' - 16'	HAND GUARDS	6855W		(*)
LIBERTY 200	04' - 10'	TRAFIC	5672	(*)	(*)
LIBERTY 200	04' - 10'	URBAN	8468	(*)	(*)
LIBERTY 200	04' - 10'	T.G.	1994W		(*)
LIBERTY 200	04' - 10'	HAND GUARDS	6855W		(*)
NEW FLY 50	13' - 18'	TRAFIC	6533	(*)	(*)
NEW FLY 50	13' - 18'	URBAN	8470	(*)	(*)
NEW FLY 125	13' - 18'	TRAFIC	6533	(*)	(*)
NEW FLY 125	13' - 18'	URBAN	8470	(*)	(*)
MEDLEY 125/S	16' - 18'	TRAFIC	9197	(*)	(*)
MEDLEY 125/S	16' - 18'	URBAN	9198	(*)	(*)
MEDLEY 125/S	16' - 18'	T.S.	9199W		(*)
MEDLEY 125/S	16' - 18'	HAND GUARDS	6855W		(*)
MEDLEY 150/S	16' - 18'	TRAFIC	9197	(*)	(*)
MEDLEY 150/S	16' - 18'	URBAN	9198	(*)	(*)
MEDLEY 150/S	16' - 18'	T.S.	9199W		(*)
MEDLEY 150/S	16' - 18'	HAND GUARDS	6855W		(*)
NRG 50		CITY SPORT	0704H	(*)	
NRG 50		CITY TOURING	0671H	(*)	
NRG 50		HAND GUARDS	6855W		(*)
NRG 50 POWER	05' - 18'	CITY SPORT	2390H	(*)	
NRG 50 POWER	05' - 18'	CITY TOURING	2403H	(*)	
NRG 50 POWER	05' - 18'	HAND GUARDS	6855W		(*)
SKIPPER LX125		CITY TOURING	0478H	(*)	
SKIPPER LX125		HAND GUARDS	6855W		(*)
SKIPPER LXT150		CITY TOURING	0478H	(*)	
SKIPPER LXT150		HAND GUARDS	6855W		(*)
TYPHOON 50/125		CITY SPORT	1681H	(*)	
TYPHOON 50/125		CITY TOURING	1683H	(*)	
TYPHOON 50/125		TRAFIC	6015	(*)	(*)
TYPHOON 50/125		URBAN	8471	(*)	(*)
TYPHOON 50/125		HAND GUARDS	6855W		(*)
VESPA S SPORT 50/125	08' - 11'	TRAFIC	5844	(*)	(*)

(W) (H) COLORS: CITY SPORT

(W) (H) COLORS: CITY TOURING

(W) (H) COLORS: TRAFIC

(W) COLORS: T.G.

(W) COLORS: T.S.

(W) COLORS: HAND GUARDS

(W) (H) COLORS: URBAN

(*) Check price with your distributor.

IMPORTANT: Indicate code color after part#. Example: 0973A.

WINDSHIELDS FOR SCOOTERS

HI-TECH PARTS | TYPE OF WINDSHIELD:

2019
MODELS:
www.puig.tv

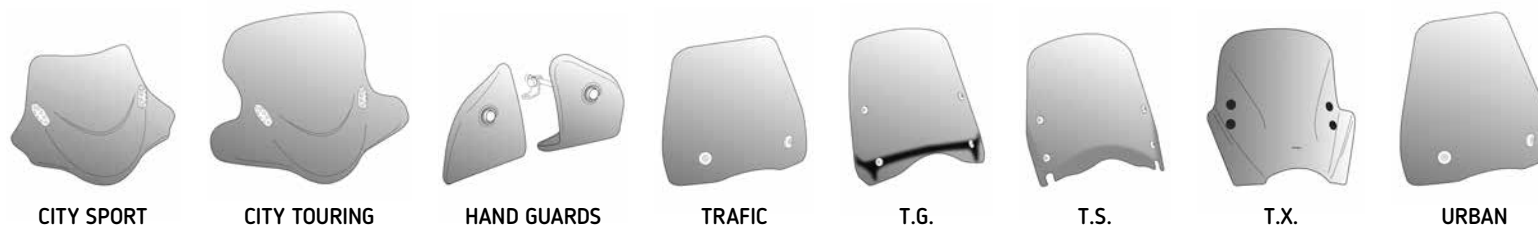

MODEL	YEAR	TYPE OF WINDSHIELD	REFERENCE	H	W
VESPA S SPORT 50/125	08' - 11'	URBAN	8472	(*)	(*)
VESPA S SPORT 50/125	08' - 11'	HAND GUARDS	6855W		(*)
VESPA GTS125/300		HAND GUARDS	6855W		(*)
VESPA PRIMAVERA 50/125/150		T.S.	9029W		(*)
VESPA PRIMAVERA 50/125/150		HAND GUARDS	6855W		(*)
VESPA SPRINT 50/125/150		HAND GUARDS	6855W		(*)
VESPINO F-9		HAND GUARDS	6855W		(*)
ZIP 50	97' - 18'	TRAFIC	6534	(*)	(*)
ZIP 50	97' - 18'	URBAN	8473	(*)	(*)
ZIP 50	97' - 18'	HAND GUARDS	6855W		(*)
SUZUKI					
ADDRESS/GP		TRAFIC	7674	(*)	(*)
ADDRESS/GP		URBAN	8474	(*)	(*)
ADDRESS/GP		T.S.	7675W		(*)
ADDRESS/GP		HAND GUARDS	6855W		(*)
ESTILETE 50	00' - 01'	CITY SPORT	0786H	(*)	
ESTILETE 50	00' - 01'	CITY TOURING	0895H	(*)	
ESTILETE 50	00' - 01'	HAND GUARDS	6855W		(*)
ZILLION	99' - 00'	CITY SPORT	0394H	(*)	
ZILLION	99' - 00'	CITY TOURING	0395H	(*)	
ZILLION	99' - 00'	HAND GUARDS	6855W		(*)
SIXTEEN 125 /150	08' - 16'	TRAFIC	5657	(*)	(*)
SIXTEEN 125 /150	08' - 16'	URBAN	8475	(*)	(*)
SYM					
HD 125/EVO		HAND GUARDS	6855W		(*)
HD 200	05' - 07'	HAND GUARDS	6855W		(*)
HD2 125/200i		CITY SPORT	6369H	(*)	
HD2 125/200i		CITY TOURING	6370H	(*)	
HD2 125/200i		TRAFIC	6373	(*)	(*)
HD2 125/200i		URBAN	8476	(*)	(*)
JET4 50/125		CITY SPORT	7676H	(*)	
JET4 50/125		CITY TOURING	7677H	(*)	
JET4 50/125		TRAFIC	9677	(*)	(*)
JET4 50/125		URBAN	9678	(*)	(*)
JET4 50/125		HAND GUARDS	6855W		(*)
FIDDLE II 50		URBAN	8180	(*)	(*)
FIDDLE II 50		TRAFIC	8179	(*)	(*)
FIDDLE II 50		T.S.	6331W		(*)
FIDDLE II 50		HAND GUARDS	6855W		(*)

MODEL	YEAR	TYPE OF WINDSHIELD	REFERENCE	H	W
FIDDLE II 125		URBAN	8180	(*)	(*)
FIDDLE II 125		TRAFIC	8179	(*)	(*)
FIDDLE II 125		T.S.	6331W		(*)
FIDDLE II 125		HAND GUARDS	6855W		(*)
FIDDLE II 150		URBAN	8180	(*)	(*)
FIDDLE II 150		TRAFIC	8179	(*)	(*)
FIDDLE II 150		T.S.	6331W		(*)
FIDDLE II 150		HAND GUARDS	6855W		(*)
FIDDLE III 50		URBAN	9240	(*)	(*)
FIDDLE III 50		TRAFIC	9239	(*)	(*)
FIDDLE III 50		T.S.	7678W		(*)
FIDDLE III 50		HAND GUARDS	6855W		(*)
FIDDLE III 125		URBAN	9240	(*)	(*)
FIDDLE III 125		TRAFIC	9239	(*)	(*)
FIDDLE III 125		T.S.	7678W		(*)
FIDDLE III 125		HAND GUARDS	6855W		(*)
MASK 125	18'	TRAFIC	9792	(*)	(*)
MASK 125	18'	URBAN	9793	(*)	(*)
MASK 125	18'	HAND GUARDS	6855W		(*)
MIO 115	18'	URBAN	9776	(*)	(*)
MIO 115	18'	TRAFIC	9775	(*)	(*)
MIO 115	18'	HAND GUARDS	6855W		(*)
SYMPHONY S 50		TRAFIC	7546	(*)	(*)
SYMPHONY S 50		URBAN	8477	(*)	(*)
SYMPHONY S 50		T.S.	6257W		(*)
SYMPHONY S 50		HAND GUARDS	6855W		(*)
SYMPHONY SR 50	09' - 10'	T.S.	6257W		(*)
SYMPHONY SR 50	09' - 10'	HAND GUARDS	6855W		(*)
SYMPHONY SR 50	11' - 18'	TRAFIC	5978	(*)	(*)
SYMPHONY SR 50	11' - 18'	URBAN	8478	(*)	(*)
SYMPHONY SR 50	11' - 18'	T.S.	5856W		(*)
SYMPHONY SR 50	11' - 18'	HAND GUARDS	6855W		(*)
SYMPHONY S 125		TRAFIC	7546	(*)	(*)
SYMPHONY S 125		URBAN	8477	(*)	(*)
SYMPHONY S 125		T.S.	6257W		(*)
SYMPHONY S 125		HAND GUARDS	6855W		(*)
SYMPHONY SR 125	09' - 10'	T.G.	6257W		(*)
SYMPHONY SR 125	09' - 10'	HAND GUARDS	6855W		(*)
SYMPHONY SR 125	11' - 18'	TRAFIC	5978	(*)	(*)
SYMPHONY SR 125	11' - 18'	URBAN	8478	(*)	(*)
SYMPHONY SR 125	11' - 18'	T.S.	5856W		(*)
SYMPHONY SR 125	11' - 18'	HAND GUARDS	6855W		(*)
SYMPHONY ST 125	15' - 18'	TRAFIC	8179	(*)	(*)

(W) (H) COLORS: CITY SPORT

(W) (H) COLORS: CITY TOURING

(W) (H) COLORS: TRAFIC

(W) COLORS: T.G.

(W) COLORS: T.S.

(W) COLORS: HAND GUARDS

(W) (H) COLORS: URBAN

(*) Check price with your distributor.

IMPORTANT: Indicate code color after part#. Example: 0973A.

WINDSHIELDS FOR SCOOTERS

HI-TECH PARTS | TYPE OF WINDSHIELD:

2019
MODELS:
www.puig.tv

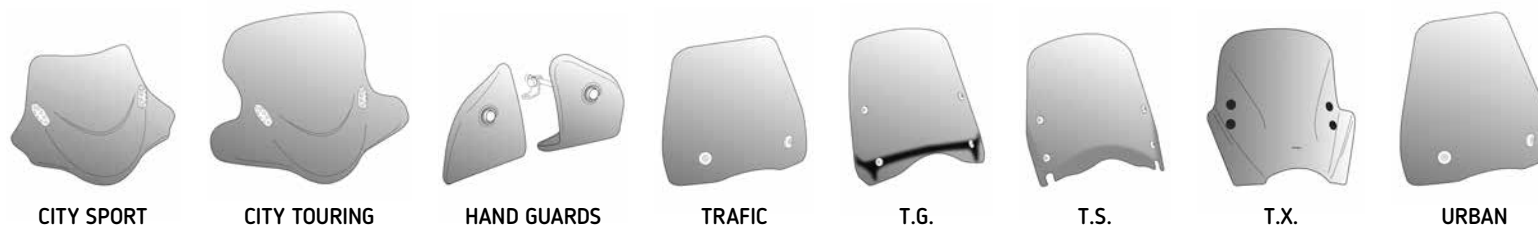

MODEL	YEAR	TYPE OF WINDSHIELD	REFERENCE	H	W
SYMPHONY ST 125	15' - 18'	URBAN	8180	(*)	(*)
SYMPHONY ST 125	15' - 18'	T.S.	6331W		(*)
SYMPHONY ST 125	18'	T.X.	9763W		(*)
SYMPHONY ST 200i	15' - 18'	TRAFIC	8179	(*)	(*)
SYMPHONY ST 200i	15' - 18'	URBAN	8180	(*)	(*)
SYMPHONY ST 200i	15' - 18'	T.S.	6331W		(*)
SYMPHONY ST 200i	18'	T.X.	9763W		(*)
SYMPHONY S 150		TRAFIC	7546	(*)	(*)
SYMPHONY S 150		URBAN	8477	(*)	(*)
SYMPHONY S 150		T.S.	6257W		(*)
SYMPHONY S 150		HAND GUARDS	6855W		(*)
SYMPHONY SR 150	09' - 10'	T.G.	6257W		(*)
SYMPHONY SR 150	09' - 10'	HAND GUARDS	6855W		(*)
SYMPHONY SR 150	11' - 18'	TRAFIC	5978	(*)	(*)
SYMPHONY SR 150	11' - 18'	URBAN	8478	(*)	(*)
SYMPHONY SR 150	11' - 18'	T.S.	5856W		(*)
SYMPHONY SR 150	11' - 18'	HAND GUARDS	6855W		(*)
YAMAHA					
AEROX/R	97' - 13'	CITY SPORT	1072H	(*)	
AEROX/R	97' - 13'	CITY TOURING	1142H	(*)	
AEROX/R	97' - 13'	HAND GUARDS	6855W		(*)
AEROX 4	14' - 18'	CITY SPORT	9679H	(*)	
AEROX 4	14' - 18'	CITY TOURING	9680H	(*)	
AEROX 4	14' - 18'	TRAFIC	9681	(*)	(*)
AEROX 4	14' - 18'	URBAN	9682	(*)	(*)
AEROX 4	14' - 18'	HAND GUARDS	6855W		(*)
AXIS PLUS		HAND GUARDS	6855W		(*)
CYGNUS R	94' - 00'	CITY SPORT	0637H	(*)	
CYGNUS R	94' - 00'	CITY TOURING	0820H	(*)	
CYGNUS R	01' - 03'	CITY SPORT	0998H	(*)	
CYGNUS R	01' - 03'	CITY TOURING	0698H	(*)	
CYGNUS X	04' - 13'	CITY SPORT	1934H	(*)	
CYGNUS X	04' - 13'	CITY TOURING	1935H	(*)	
CYGNUS X	10' - 13'	TRAFIC	6535	(*)	(*)
CYGNUS X	10' - 13'	URBAN	8479	(*)	(*)
CYGNUS X	10' - 13'	T.S.	6812W		(*)
CYGNUS X	10' - 13'	HAND GUARDS	6855W		(*)
D'ELIGHT	13' - 16'	TRAFIC	6882	(*)	(*)
D'ELIGHT	13' - 16'	URBAN	8480	(*)	(*)

MODEL	YEAR	TYPE OF WINDSHIELD	REFERENCE	H	W
D'ELIGHT	13' - 16'	HAND GUARDS	6855W		(*)
D'ELIGHT	17' - 18'	TRAFIC	9970	(*)	(*)
D'ELIGHT	17' - 18'	URBAN	9971	(*)	(*)
D'ELIGHT	17' - 18'	T.S.	9972W		(*)
D'ELIGHT	17' - 18'	HAND GUARDS	6855W		(*)
JOG R/JOG RR		CITY SPORT	1305H	(*)	
JOG R/JOG RR		CITY TOURING	1306H	(*)	
JOG R/JOG RR		TRAFIC	6019	(*)	(*)
JOG R/JOG RR		URBAN	8481	(*)	(*)
JOG R/JOG RR		HAND GUARDS	6855W		(*)
MAXSTER 125	01' - 03'	CITY SPORT	1134H	(*)	
MAXSTER 125	01' - 03'	CITY TOURING	1135H	(*)	
MAXSTER 125	01' - 03'	HAND GUARDS	6855W		(*)
MAXSTER 150	01' - 03'	CITY SPORT	1134H	(*)	
MAXSTER 150	01' - 03'	CITY TOURING	1135H	(*)	
MAXSTER 150	01' - 03'	HAND GUARDS	6855W		(*)
NEO'S	99' - 08'	CITY SPORT	0466H	(*)	
NEO'S	99' - 08'	CITY TOURING	0186H	(*)	
NEO'S	09' - 14'	CITY SPORT	4925H	(*)	
NEO'S	09' - 14'	CITY TOURING	4926H	(*)	
NEO'S	09' - 14'	TRAFIC	6018	(*)	(*)
NEO'S	09' - 14'	URBAN	8482	(*)	(*)
NEO'S	09' - 14'	HAND GUARDS	6855W		(*)
NEO'S 4	15' - 18'	CITY SPORT	4925H	(*)	
NEO'S 4	15' - 18'	CITY TOURING	4926H	(*)	
NEO'S 4	15' - 18'	TRAFIC	6018	(*)	(*)
NEO'S 4	15' - 18'	URBAN	8482	(*)	(*)
NEO'S 4	15' - 18'	HAND GUARDS	6855W		(*)
TEOS 125	00' - 13'	CITY SPORT	0439H	(*)	
TEOS 125	00' - 13'	CITY TOURING	0376H	(*)	
TEOS 125	00' - 13'	HAND GUARDS	6855W		(*)
VITY 125	08' - 13'	CITY SPORT	4683H	(*)	
VITY 125	08' - 13'	CITY TOURING	4684H	(*)	
VITY 125	08' - 13'	TRAFIC	5669	(*)	(*)
VITY 125	08' - 13'	URBAN	8483	(*)	(*)
VITY 125	08' - 13'	HAND GUARDS	6855W		(*)
WHY 50	99' - 13'	TRAFIC	6536	(*)	(*)
WHY 50	99' - 13'	URBAN	8484	(*)	(*)
WHY 50	99' - 13'	HAND GUARDS	6855W		(*)
XENTER 125/150	12' - 18'	CITY SPORT	6262H	(*)	
XENTER 125/150	12' - 18'	CITY TOURING	6263H	(*)	
XENTER 125/150	12' - 18'	TRAFIC	6264	(*)	(*)
XENTER 125/150	12' - 18'	URBAN	8485	(*)	(*)
XENTER 125/150	12' - 18'	HAND GUARDS	6855W		(*)

(W) (H) COLORS: CITY SPORT

(W) (H) COLORS: CITY TOURING

(W) (H) COLORS: TRAFIC

(W) COLORS: T.G.

(W) COLORS: T.S.

(W) COLORS: HAND GUARDS

(W) (H) COLORS: URBAN

(*) Check price with your distributor.

IMPORTANT: Indicate code color after part#. Example: 0973A.





SALES CONDITIONS

- 1% extra discount sending the order through our extranet on www.puig.tv.

RETURN PROCEDURES

- No return will be accepted after 3 months from shipping note.
- The return must be accepted from Motoplastic S.A., after verification of the material by an agent in the area or, otherwise, through an email sent to pedidos@puig.tv requesting the return along with detailed images.
- If the return is not Motoplastic's fault, 20% devaluation will be applied and material will need to be sent paid for.
- If the return is because of the transport, the customer will need to send us the transporter's shipping note where should be noted, at the time of the reception of the cartons, the disagreement of the condition of the material. Additionally, images of the cartons in bad condition will need to be sent to us.

BRAND AND IMAGES

PUIG® is a registered brand.

The images from this catalog and site www.puig.tv are property of Motoplastic, S.A. and need authorization from Motoplastic, S.A. for its use.

Motoplastic, s.a. does not have any link with brands HONDA, YAMAHA, SUZUKI, KAWASAKI, APRILIA, BMW, BUELL, CAGIVA, DERBI, DUCATI, HYOSUNG, KTM, MV AGUSTA, PEUGEOT, TRIUMPH and others mentioned. All products registered brand, model or initials, are named with only purpose to cross reference with accessories of our own production.

2019 Motoplastic S.A. © All rights reserved.

HEADQUARTERS

MOTOPLASTIC, S.A.
Passeig de la Ribera, n°29
08403 Granollers
Spain
Tel. +34 938490633
Fax +34 938490988
info@puig.tv

UNITED STATES

PUIG USA INC.
3843 St. Valentine Way
Orlando, FL 32811
Ph. +1 407.237.0207
info@puigusa.com

AGENT POUR LA FRANCE - ARTECH

Zac du long Buisson
180 Rue Clement Ader
Batiment 1
27000 Evreux
Tel. 02.32.305.305
Fax 02.32.305.306
Puig.artech@orange.fr



W W W . P U I G . T V