

HONDA CRF1100L AFRICA TWIN '20-

M O U N T I N G I N S T R U C T I O N S

REF 3818

TOURING SCREEN



1 Person



20 min











EASY

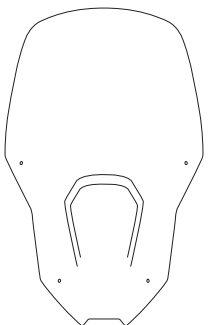
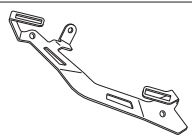
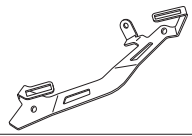

ALLEN

Nº 3
Nº 5



ID	PIEZA/PART	DESCRIPCIÓN	DESCRIPTION	QTY	REF
1		Cúpula TOURING	TOURING screen	1	3818W/H/N/FM3
2		Soporte izquierdo	Left support	1	SOPOR2P9-L-3818
3		Soporte derecho	Right support	1	SOPOR2P9-R-3818
4		Tuerca enjaulada de aluminio M5 (se suministra montada)	M5 Lock nut (supplied munted)	4	TUERCAJFM5-408
5		Casquillo Ø8,5x Ø13x 9	Ø8,5x Ø13x 9 spacer	2	CASQUI-----777
6		Tornillo Allen M5x20 Ø11 ISO 7380	M5x20 Ø11 ISO 7380 Allen screw	2	TORNI-I7380-730
7		Tornillo Allen M5x16 Ø11 ISO 7380	M5x16 Ø11 ISO 7380 Allen screw	8	TORNI-I7380-493
8		Tapón tornillo M5 ISO 7380	M5 ISO 7380 screw cap	10	TAPON-----85
9		Silentblock Ø9 xØ6 x8mm	Ø9 xØ6 x8mm silentblock	4	AROPASACABLES-3
10		Casquillo con valona Ø12xØ6,8x7,3	Ø12xØ6,8x7,3 Bush with flange	4	CASQUI-1A---750

HONDA CRF1100L AFRICA TWIN '20-

INSTRUCCIONES DE MONTAJE - MOUNTING INSTRUCTIONS - MONTAGEANLEITUNG

1

**DISASSEMBLY
DESMONTAJE**

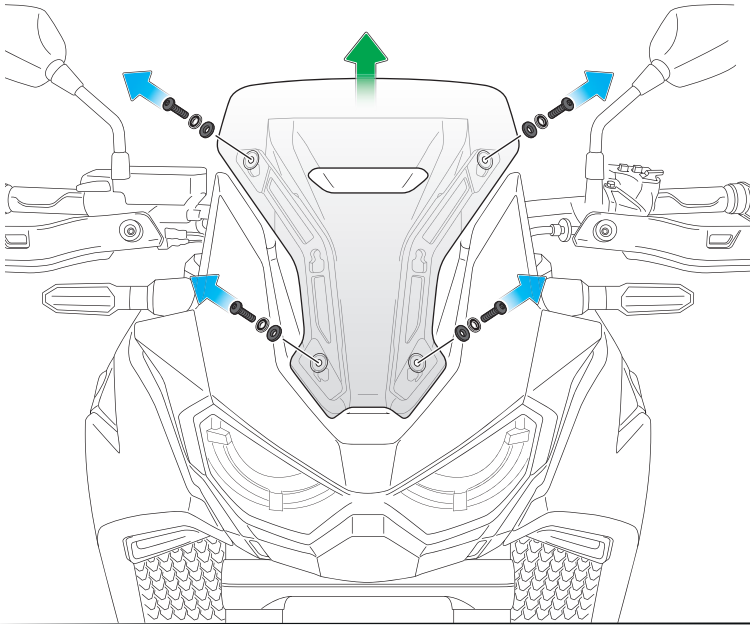

2

**DISASSEMBLY
DESMONTAJE**

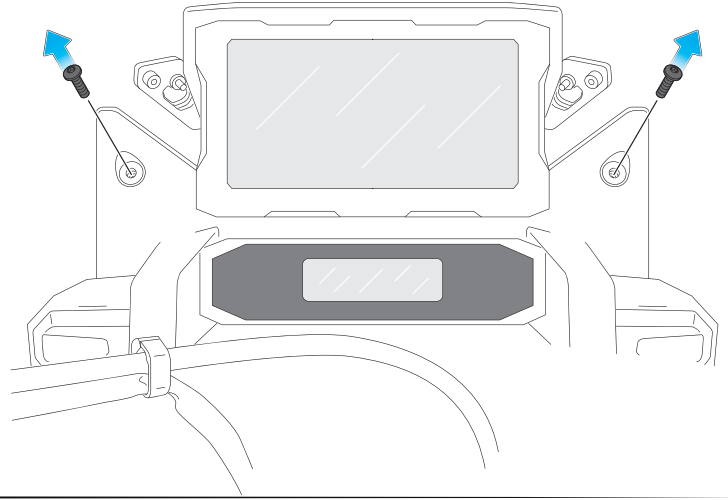

3

**ASSEMBLY
MONTAJE**

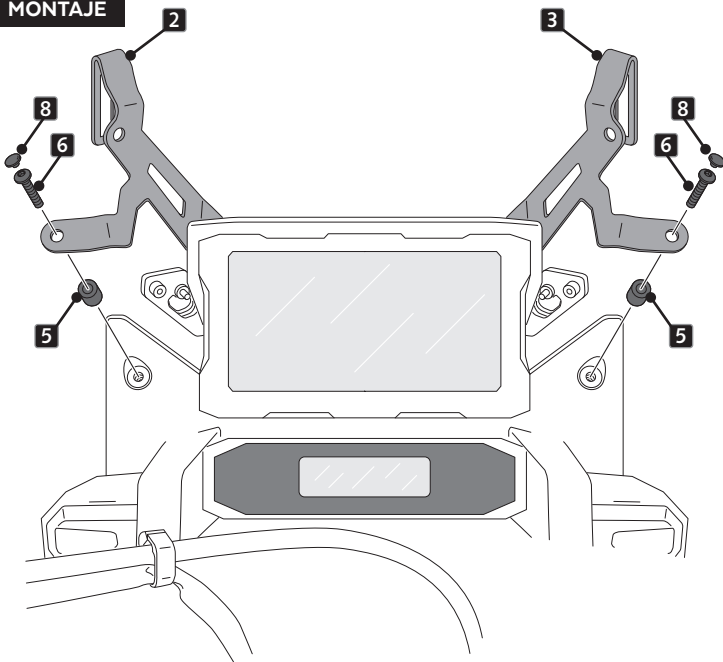

4

**ASSEMBLY
MONTAJE**

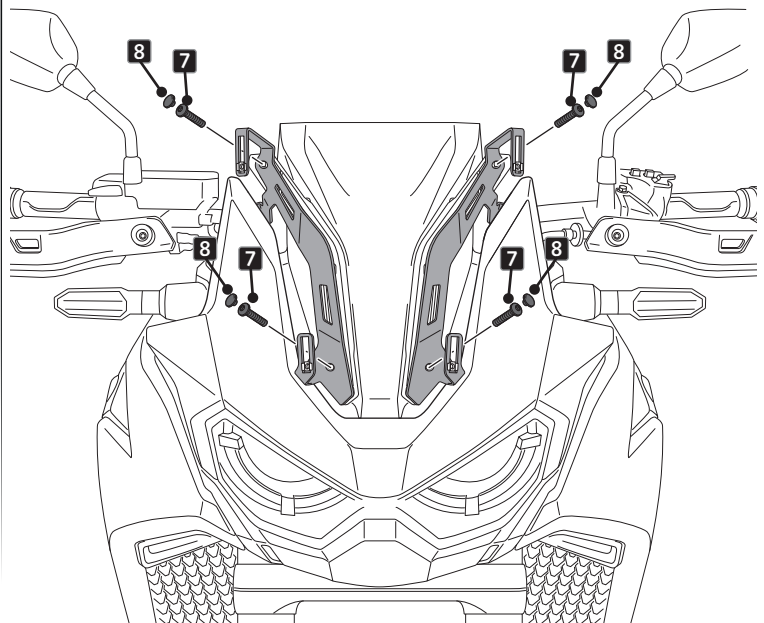

HONDA CRF1100L AFRICA TWIN '20-

INSTRUCCIONES DE MONTAJE - MOUNTING INSTRUCTIONS - MONTAGEANLEITUNG

5

ASSEMBLY
MONTAJE

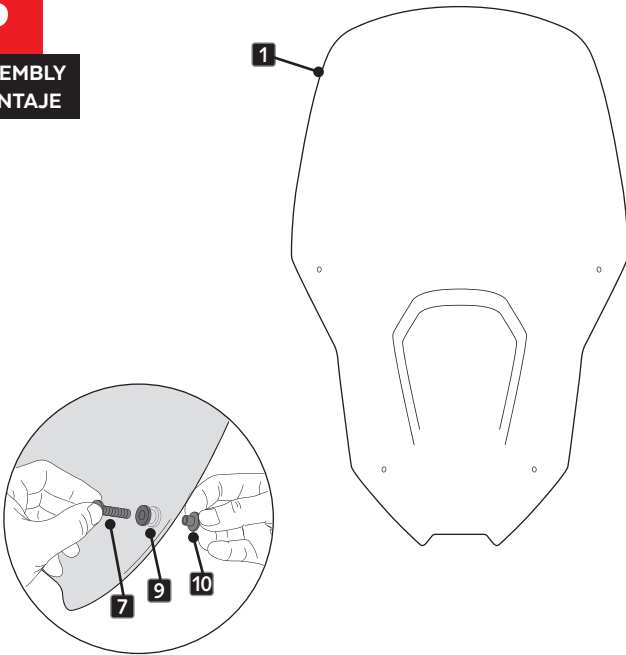

6

ASSEMBLY
MONTAJE

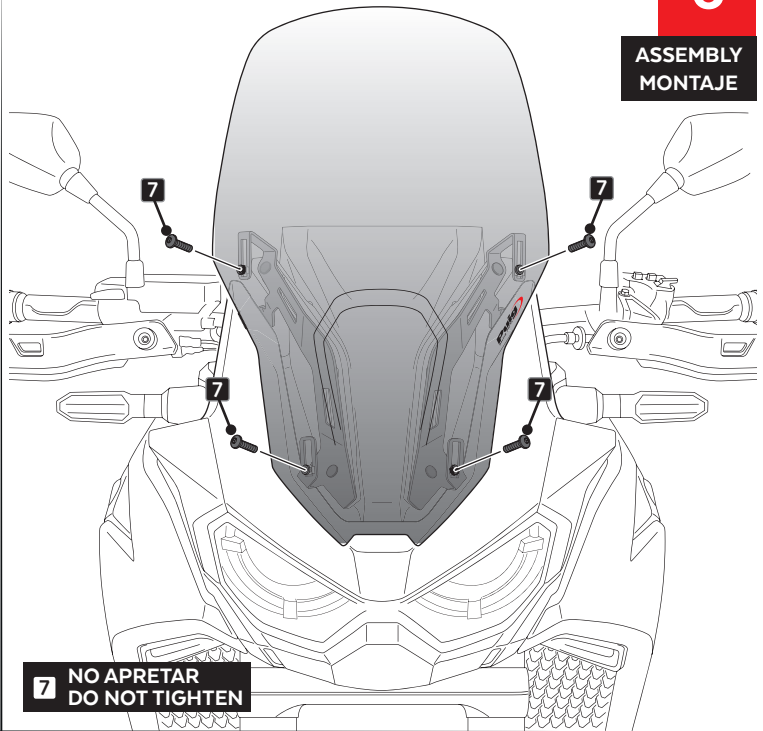

7

ASSEMBLY
MONTAJE

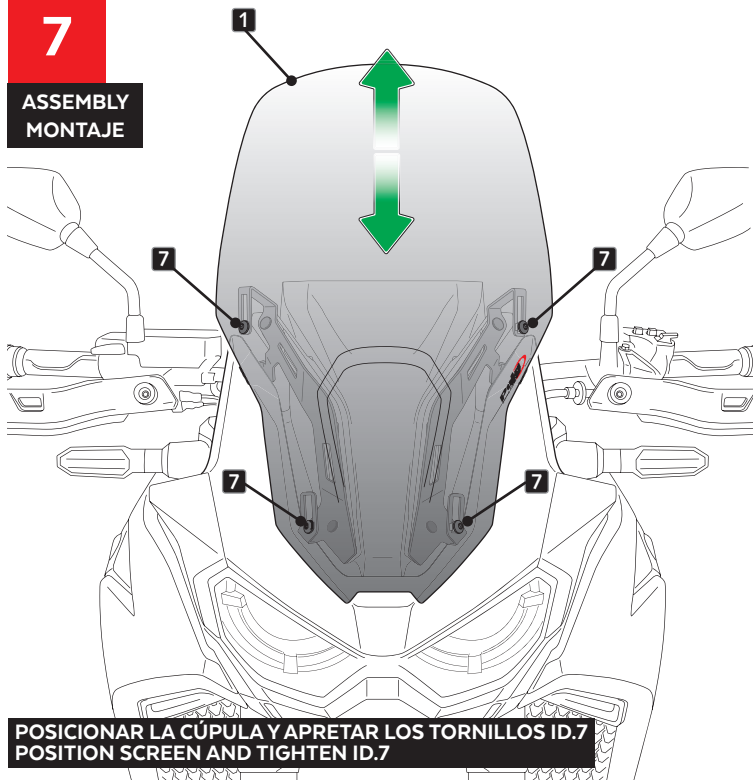

8

ASSEMBLY
MONTAJE

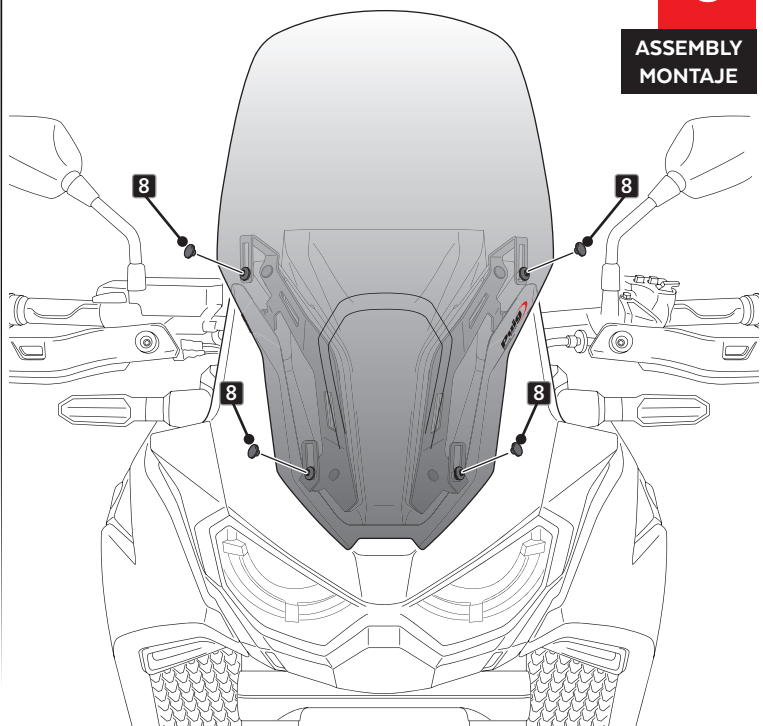

VISERA MULTIREGULABLE MULTI-ADJUSTABLE VISOR

CÚPULA TIPO
TYPE WINDSCREEN **A**



CÚPULA TIPO
TYPE WINDSCREEN **B**



CÚPULA TIPO
TYPE WINDSCREEN **C**



Ref.: 6007

Ref.: 5852

Ref.: 5853

Ahumado/Smoke

Transparente/Clear

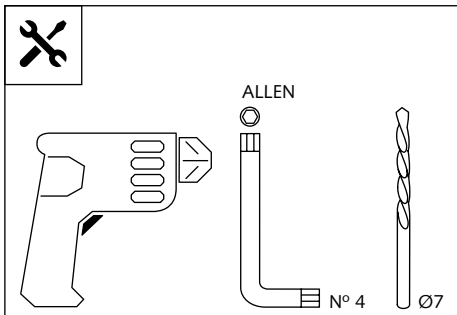

1 persona
1 person



15 min

Fácil - Easy

Media-Intermediate

Difícil-Difficult

Nota/Note:

Si la visera se suministra con la cúpula Puig, no será necesario realizar los agujeros por que ya vienen incorporados.

If the visor is supplied along with the windscreen, the windscreen will come factory-drilled so no drilling is necessary.

ID.	PIEZA / PART	DESCRIPCIÓN	DESCRIPTION	QTY.
1		Visera	Visor	1
2		Plantilla	Template	1
3		Mecanismo multiregulable	Multi-adjustable mechanism	2
4		Tapeta	Cap	4
5		Tornillo rosca plástico M6x12	Plastic thread fastener M6x12	8

VISERA MULTIREGULABLE MULTI-ADJUSTABLE VISOR

INSTRUCCIONES DE MONTAJE - MOUNTING INSTRUCTIONS - MONTAGEANLEITUNG

TIPO/TYPER A - TIPO/TYPER A - TIPO/TYPER A

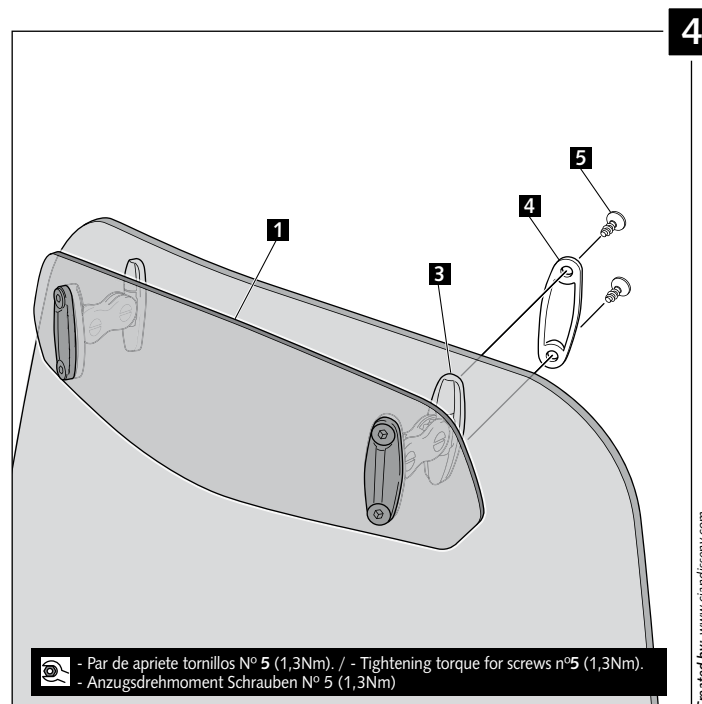
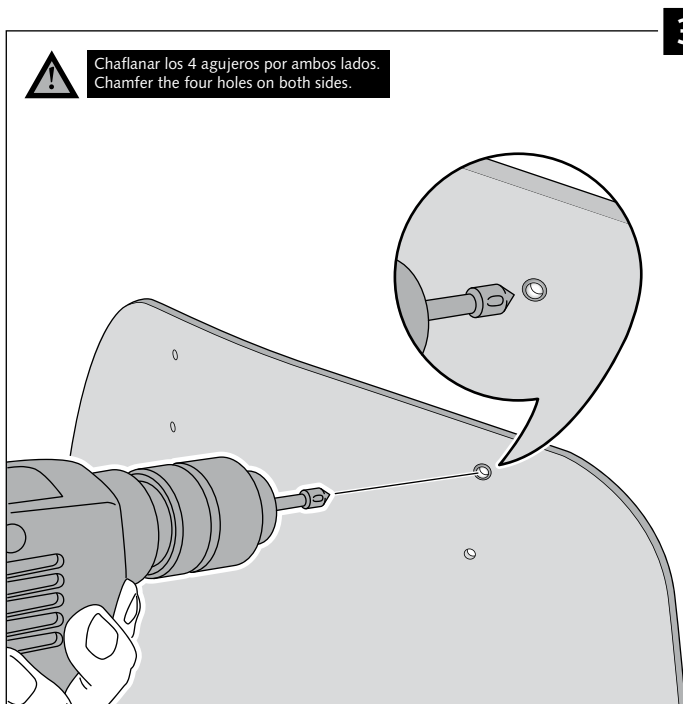
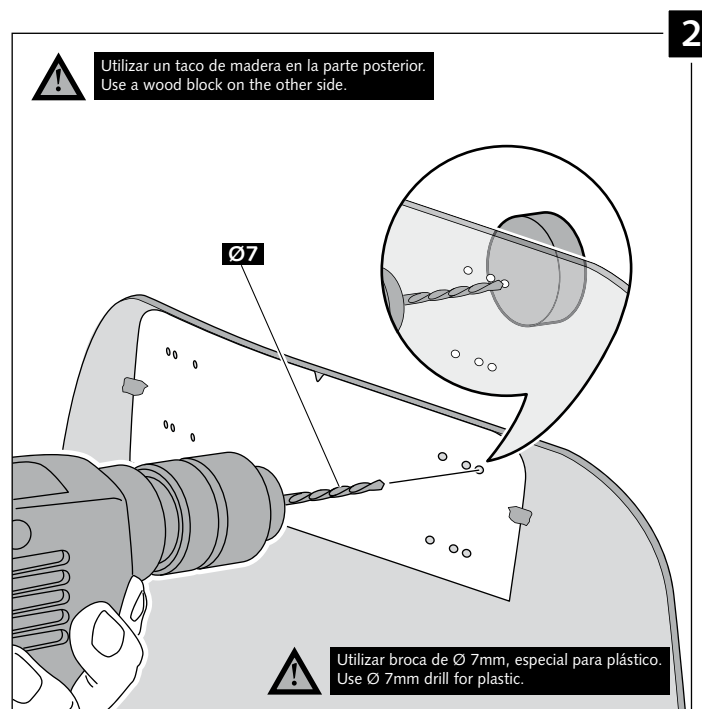
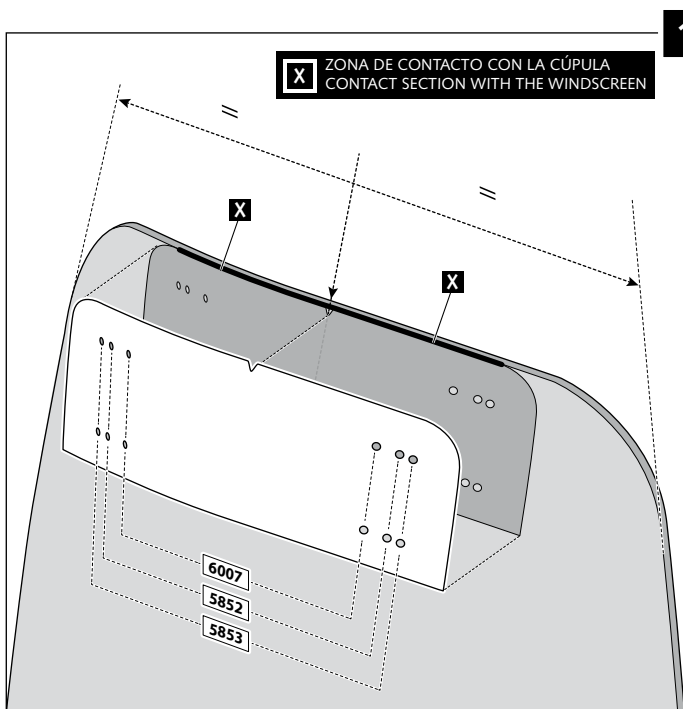

VISERA MULTIREGULABLE MULTI-ADJUSTABLE VISOR

INSTRUCCIONES DE MONTAJE - MOUNTING INSTRUCTIONS - MONTAGEANLEITUNG

TIPO/TYPE B - TIPO/TYPE B - TIPO/TYPE B

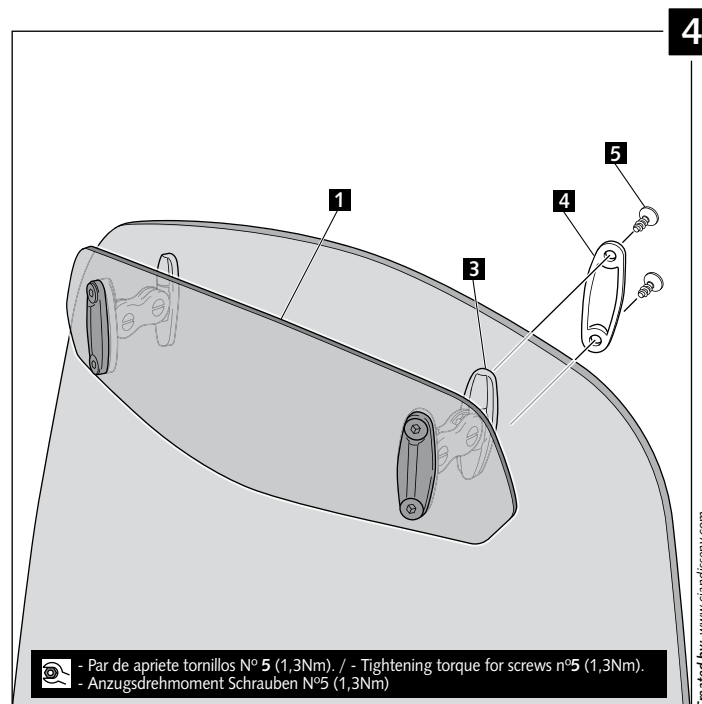
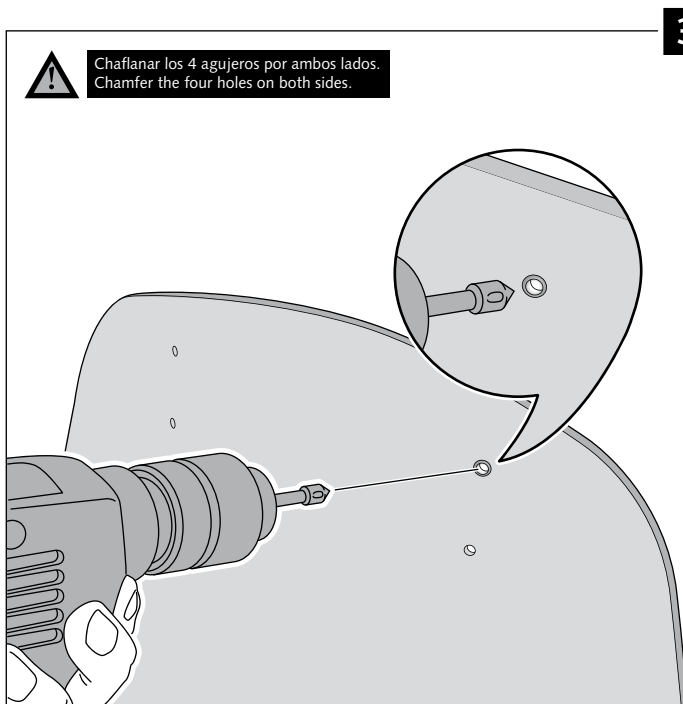
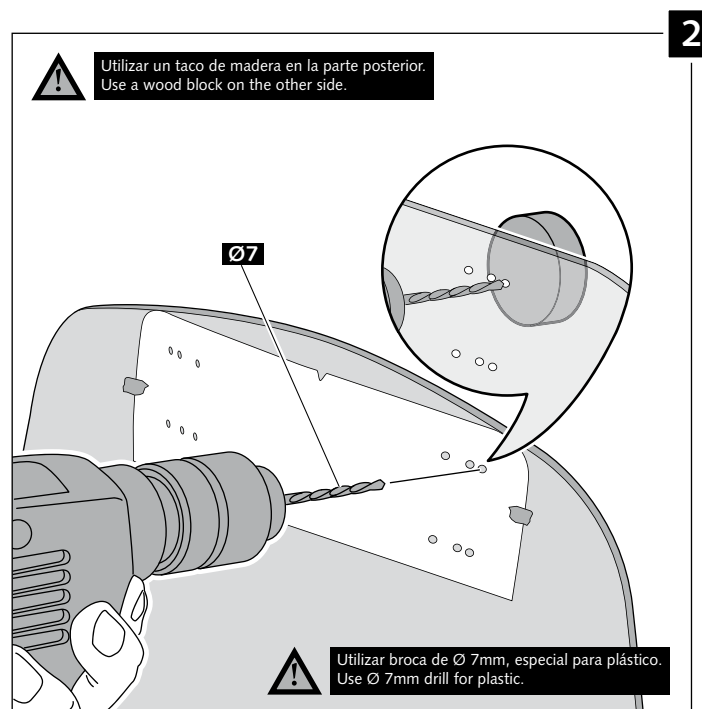
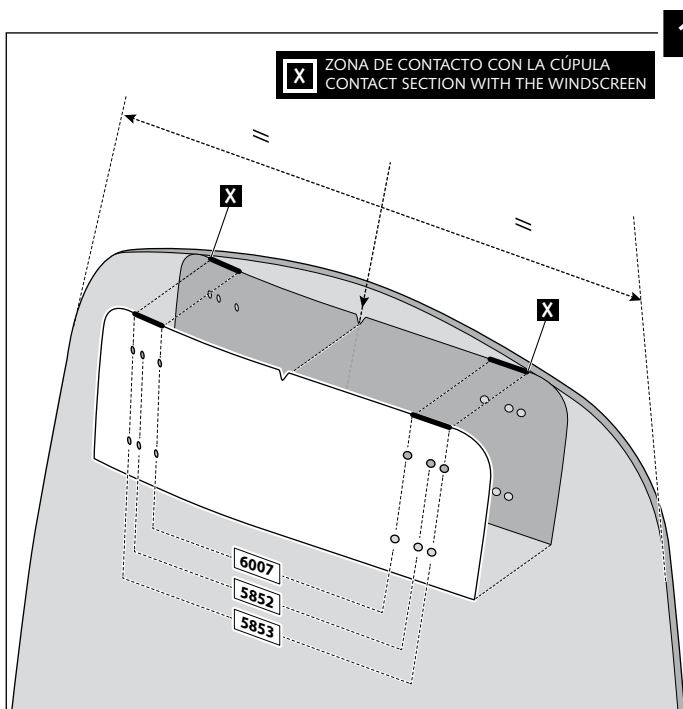

VISERA MULTIREGULABLE MULTI-ADJUSTABLE VISOR

INSTRUCCIONES DE MONTAJE - MOUNTING INSTRUCTIONS - MONTAGEANLEITUNG

TIPO/TYPER C - TIPO/TYPER C - TIPO/TYPER C

