

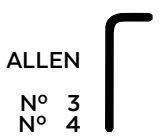

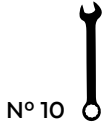



# YAMAHA NIKEN '18-

## M O U N T I N G I N S T R U C T I O N S

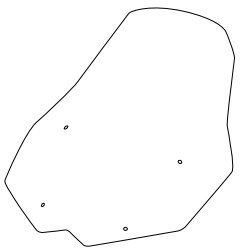
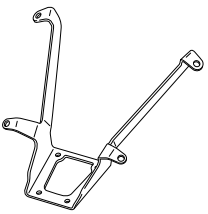
REF 2385

TOURING SCREEN



ID	PIEZA/PART	DESCRIPCIÓN	DESCRIPTION	QTY	REF
1		Cúpula touring	Touring screen	1	2385F/H/N/WM3
2		Soporte metálico	Metal support	1	SOPORIP7---2385
3		Silentblock M5	M5 silentblock	4	SILENBTM5-046/1
4		Tornillo Allen M5x20 Ø11 ISO 7380	M5x20 Ø11 ISO 7380 Allen screw	4	TORNI-I7380-730
5		Arandela de nylon M5x1	M5x1 Nylon washer	4	ARNV00000000245
6		Tapón tornillo M5 ISO 7380	M5 ISO 7380 Screw cap	4	TAPON-----85
7		Arandela de goma Ø4,5 x Ø11 x 2mm	Ø4,5 x Ø11 x 2mm Rubber washer	4	ARAND-EPDM--722

# YAMAHA NIKEN '18-

INSTRUCCIONES DE MONTAJE - MOUNTING INSTRUCTIONS - MONTAGEANLEITUNG

**1**

DISASSEMBLY  
DESMONTAJE

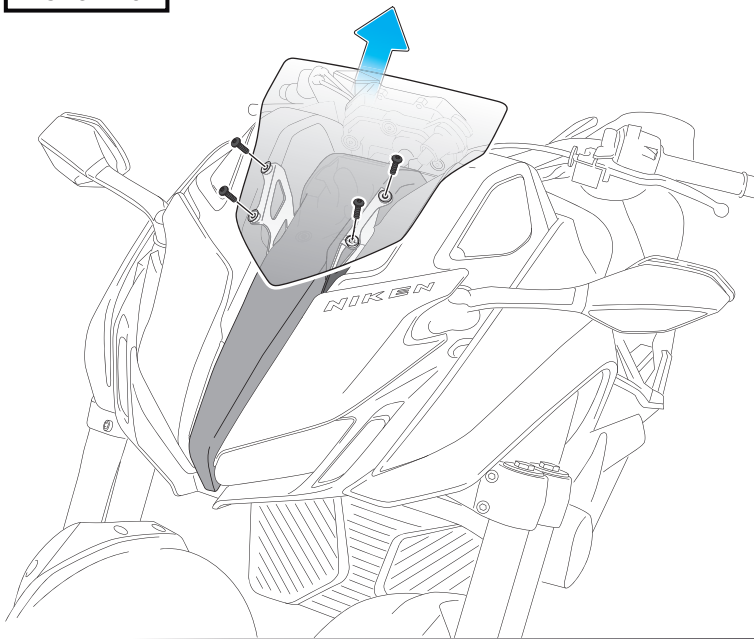

**2**

DISASSEMBLY  
DESMONTAJE

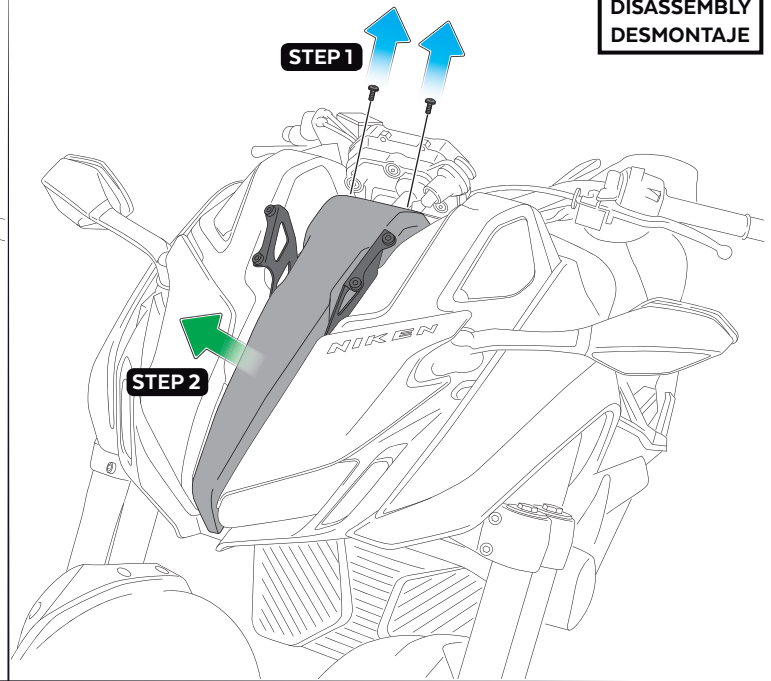

**3**

DISASSEMBLY  
DESMONTAJE

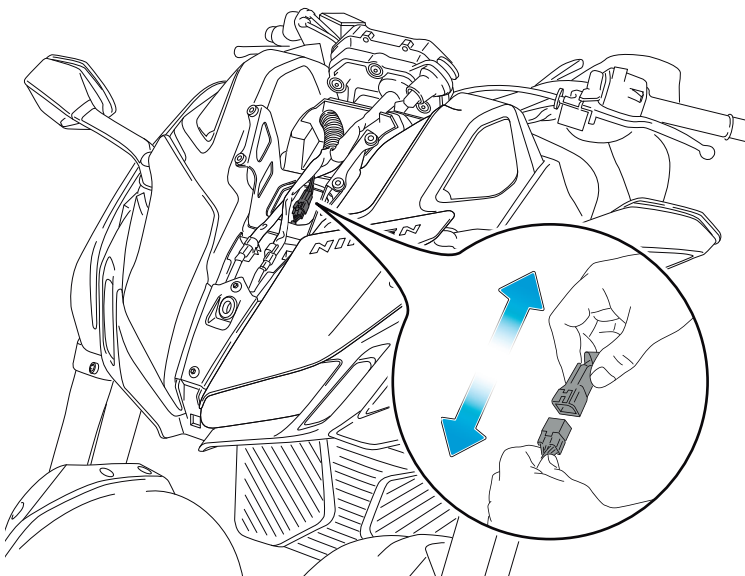

**4**

DISASSEMBLY  
DESMONTAJE

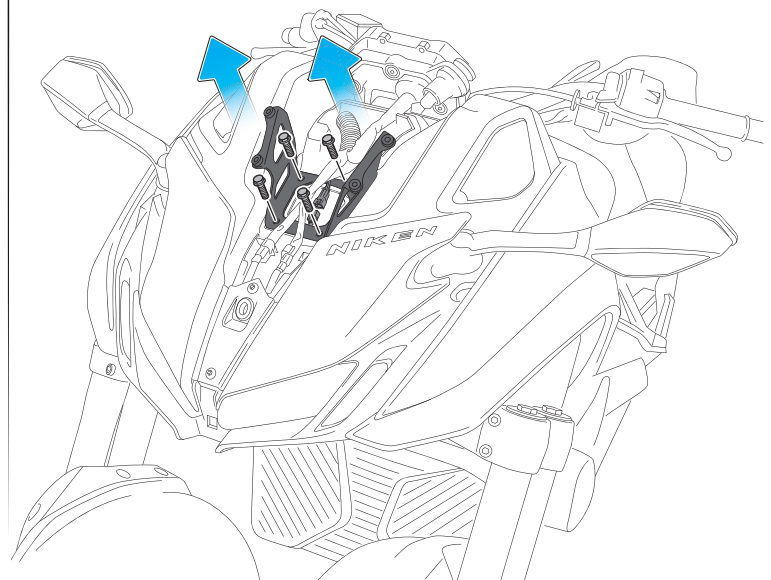

# YAMAHA NIKEN '18-

INSTRUCCIONES DE MONTAJE - MOUNTING INSTRUCTIONS - MONTAGEANLEITUNG

**5**

ASSEMBLY  
MONTAJE

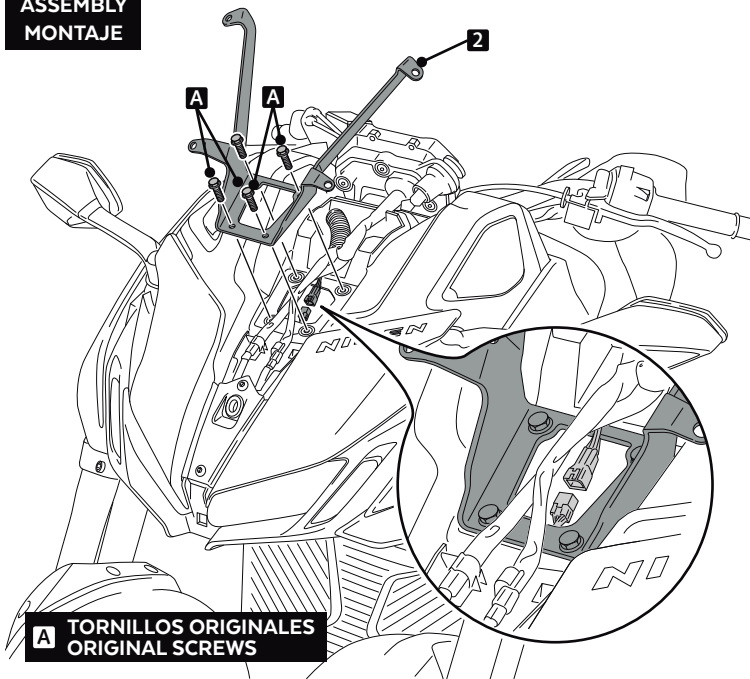

**6**

ASSEMBLY  
MONTAJE

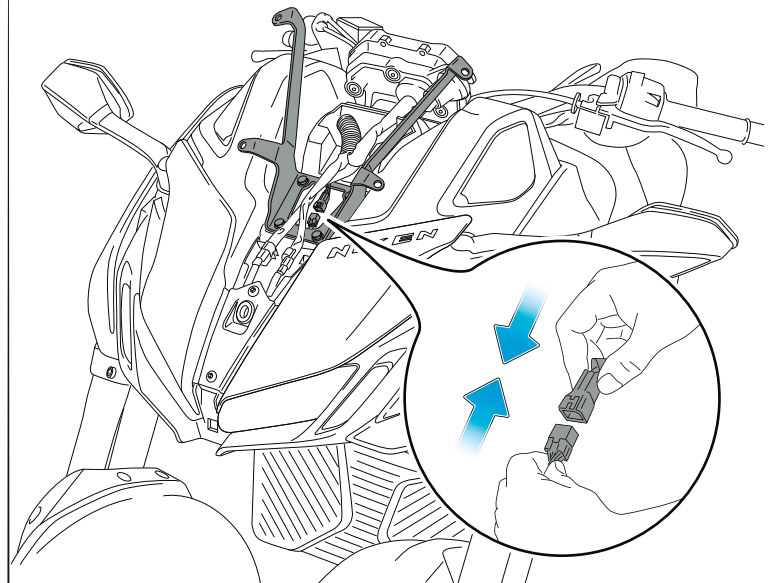

**7**

ASSEMBLY  
MONTAJE

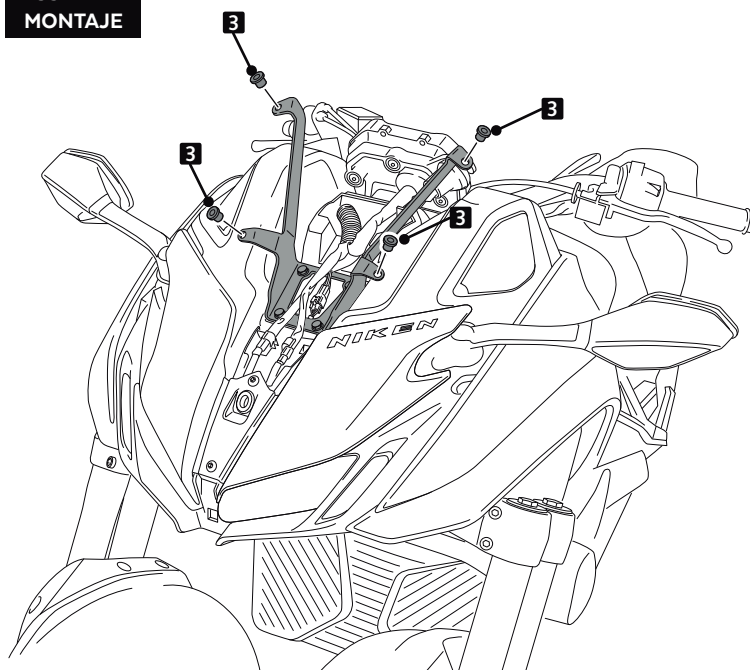

**8**

ASSEMBLY  
MONTAJE

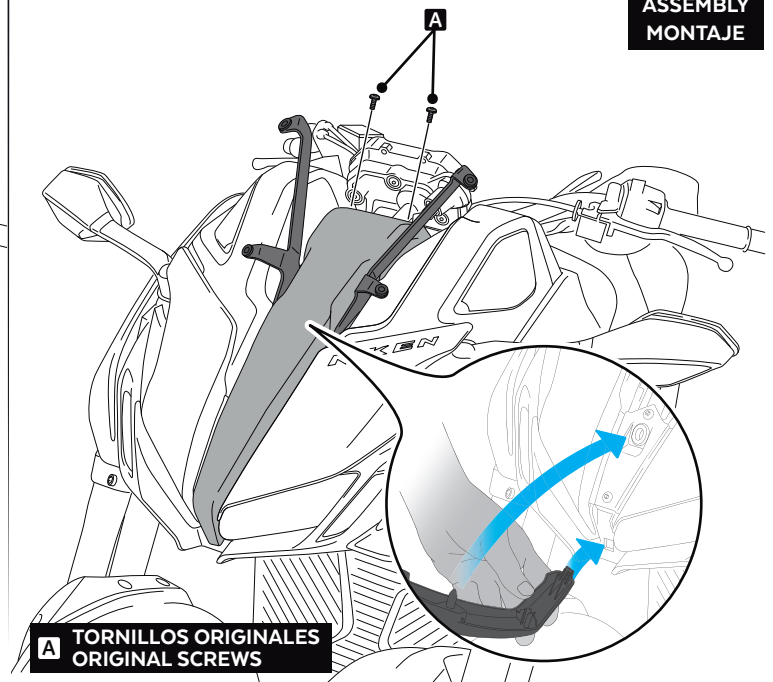

# YAMAHA NIKEN '18-

INSTRUCCIONES DE MONTAJE - MOUNTING INSTRUCTIONS - MONTAGEANLEITUNG

9

ASSEMBLY  
MONTAJE

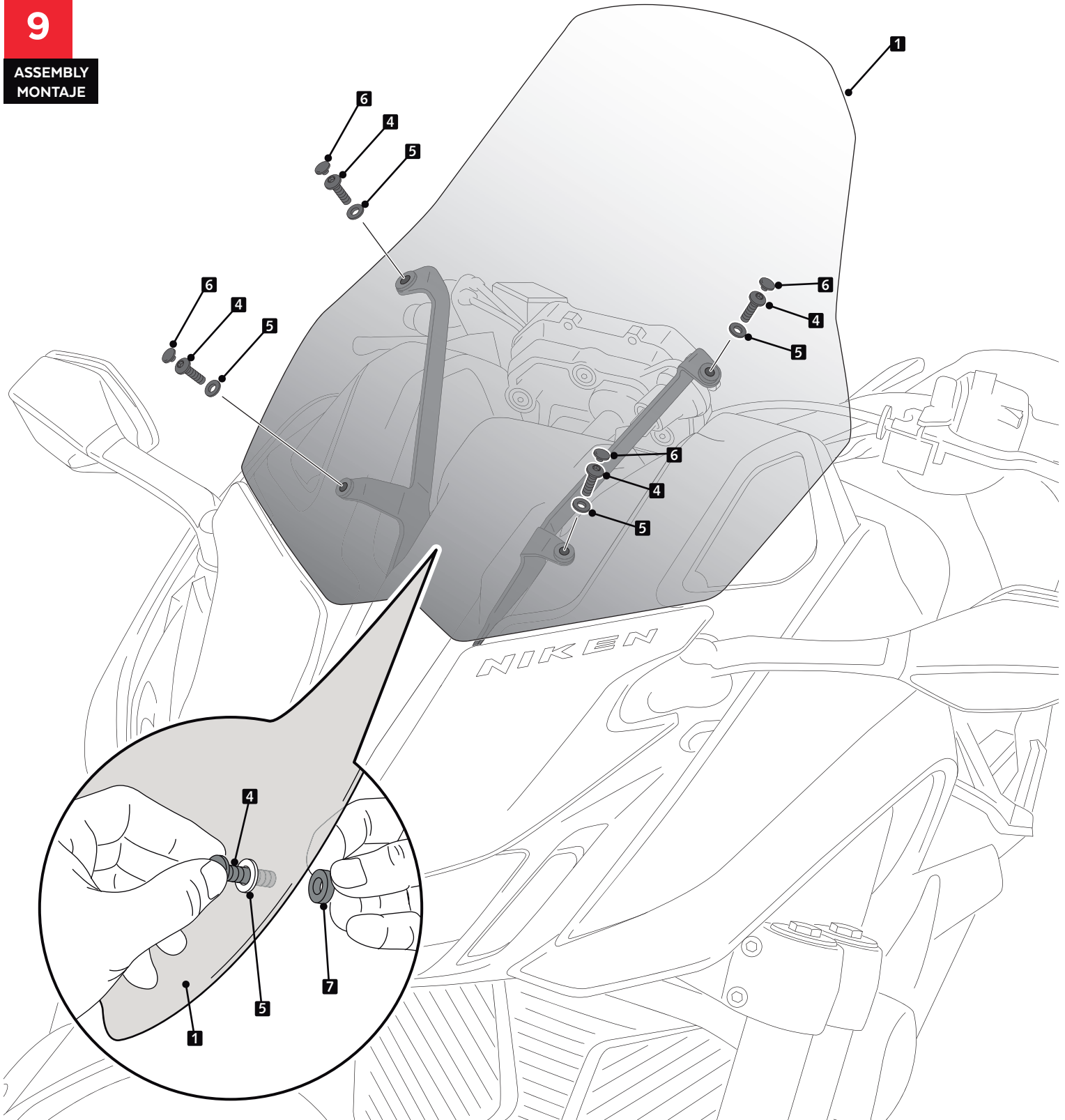



## VISERA MULTIREGULABLE MULTI-ADJUSTABLE VISOR

CÚPULA TIPO  
TYPE WINDSCREEN **A**



CÚPULA TIPO  
TYPE WINDSCREEN **B**



CÚPULA TIPO  
TYPE WINDSCREEN **C**



Ref.: 6007

Ref.: 5852

Ref.: 5853

Ahumado/Smoke

Transparente/Clear

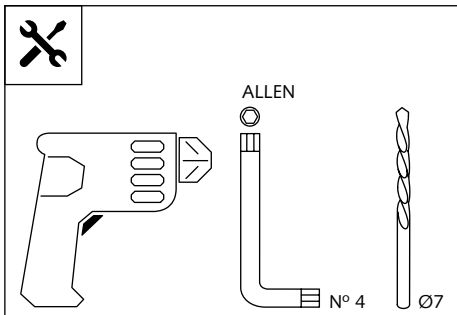

1 persona  
1 person



15 min

Fácil - Easy





Media-Intermediate

Difícil-Difficult

**Nota/Note:**

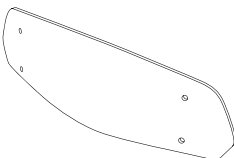
Si la visera se suministra con la cúpula Puig, no será necesario realizar los agujeros por que ya vienen incorporados.

If the visor is supplied along with the windscreen, the windscreen will come factory-drilled so no drilling is necessary.

ID.	PIEZA / PART	DESCRIPCIÓN	DESCRIPTION	QTY.
1		Visera	Visor	1
2		Plantilla	Template	1
3		Mecanismo multiregulable	Multi-adjustable mechanism	2
4		Tapeta	Cap	4
5		Tornillo rosca plástico M6x12	Plastic thread fastener M6x12	8

# VISERA MULTIREGULABLE MULTI-ADJUSTABLE VISOR

INSTRUCCIONES DE MONTAJE - MOUNTING INSTRUCTIONS - MONTAGEANLEITUNG

TIPO/TYPER A - TIPO/TYPER A - TIPO/TYPER A

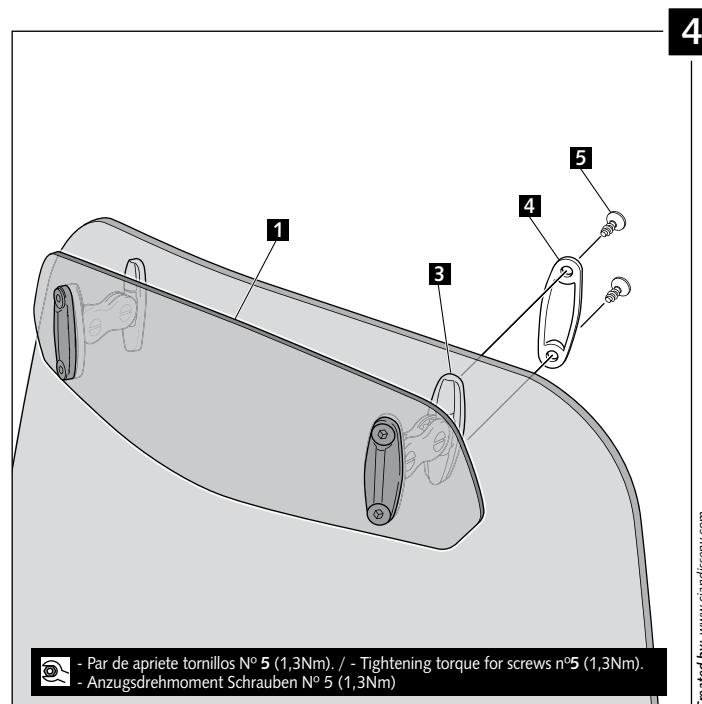
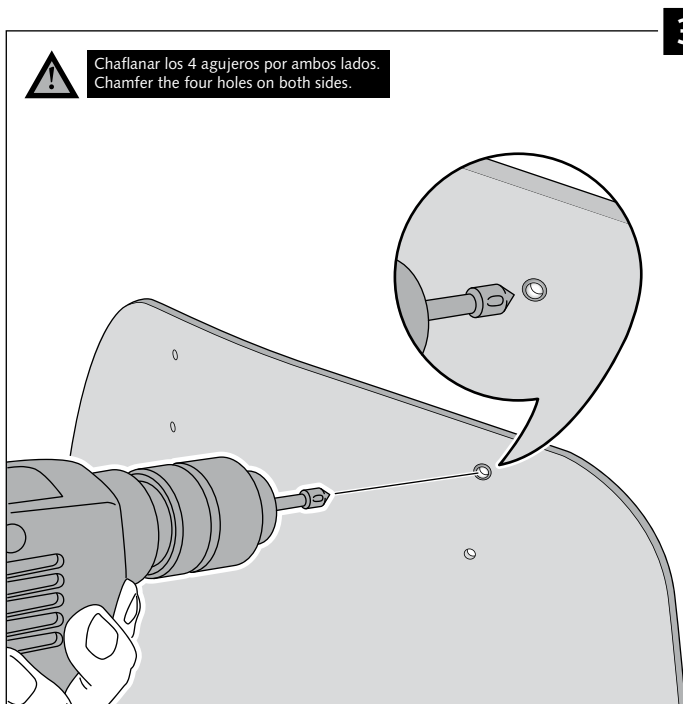
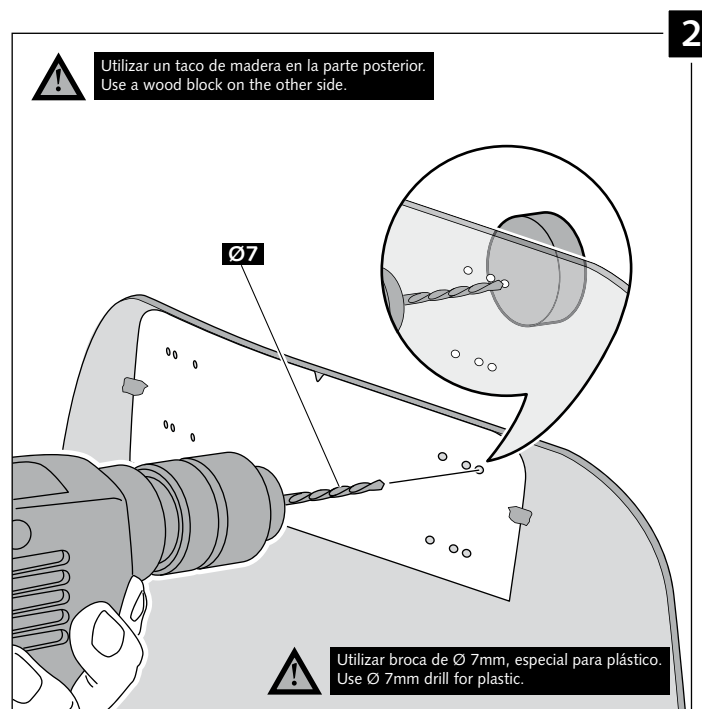
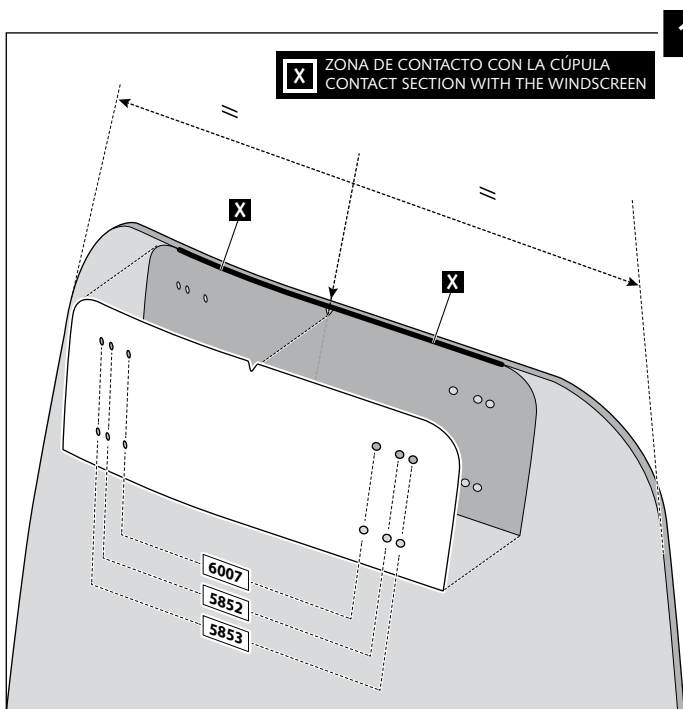

# VISERA MULTIREGULABLE MULTI-ADJUSTABLE VISOR

INSTRUCCIONES DE MONTAJE - MOUNTING INSTRUCTIONS - MONTAGEANLEITUNG

TIPO/TYPE B - TIPO/TYPE B - TIPO/TYPE B

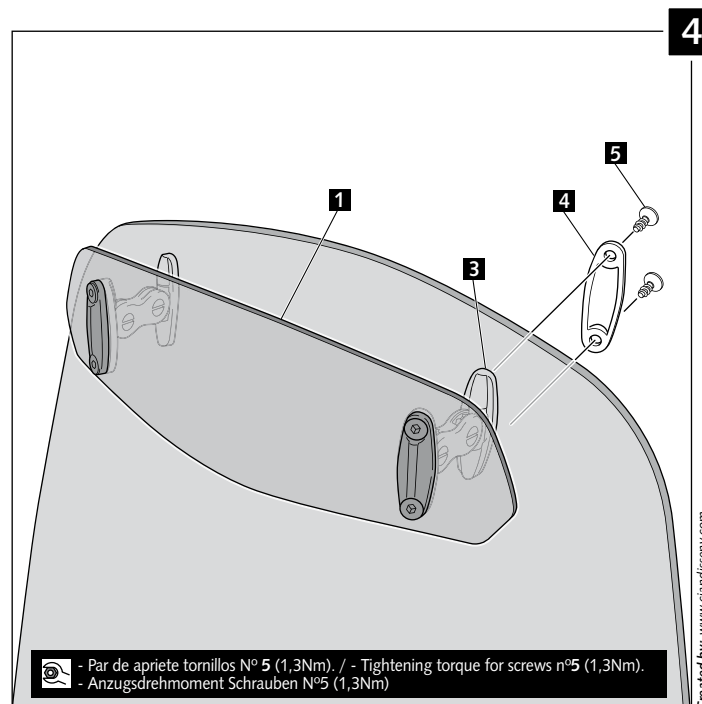
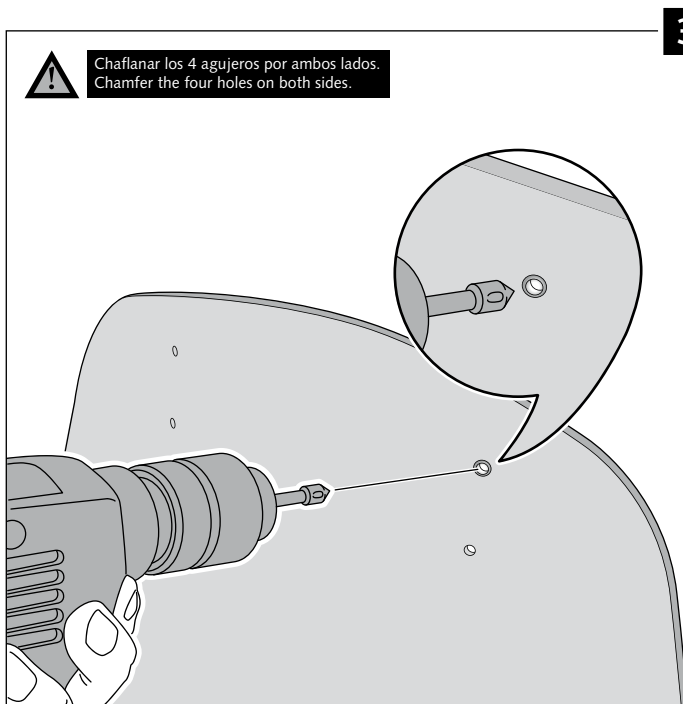
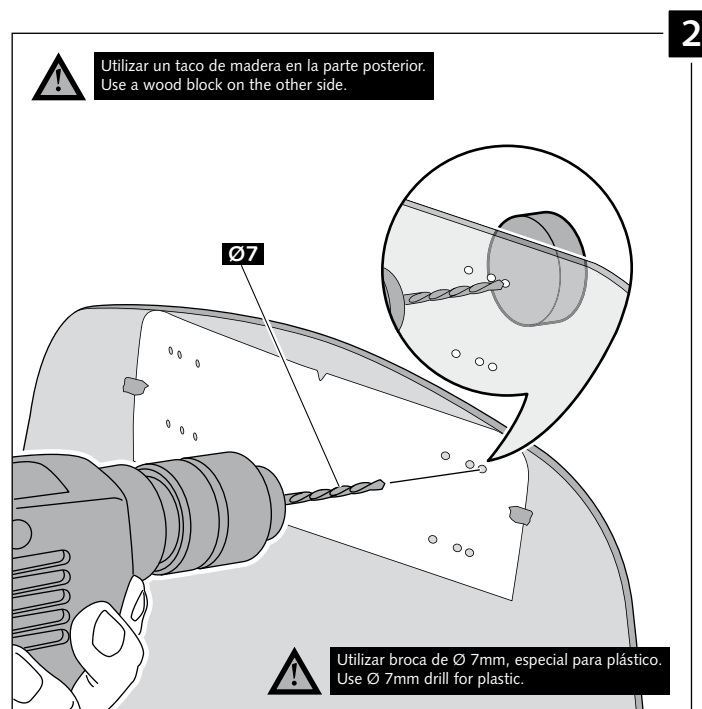
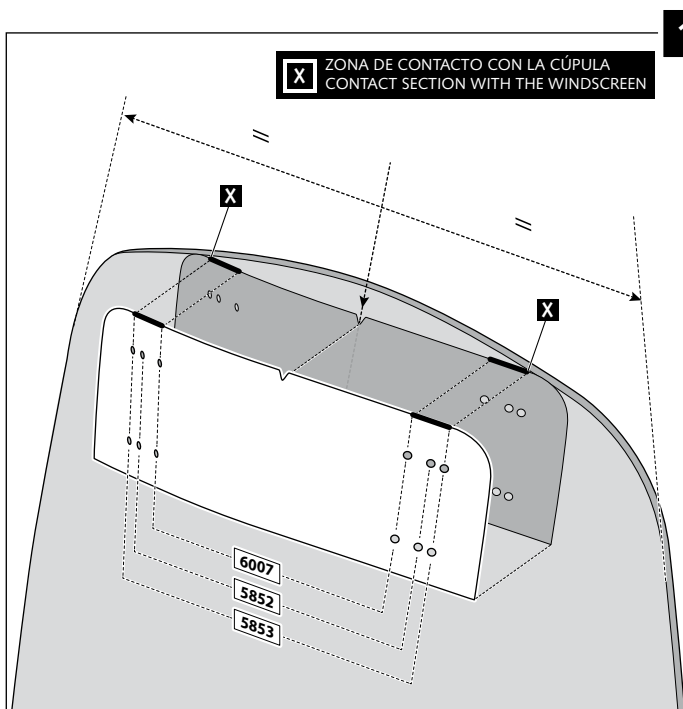

# VISERA MULTIREGULABLE MULTI-ADJUSTABLE VISOR

INSTRUCCIONES DE MONTAJE - MOUNTING INSTRUCTIONS - MONTAGEANLEITUNG

TIPO/TYPER C - TIPO/TYPER C - TIPO/TYPER C

